

User Manual – High Speed Counter

EH-RIO2 Series

RIO2-CU24 / RIO2-CU24L

Version 1.06

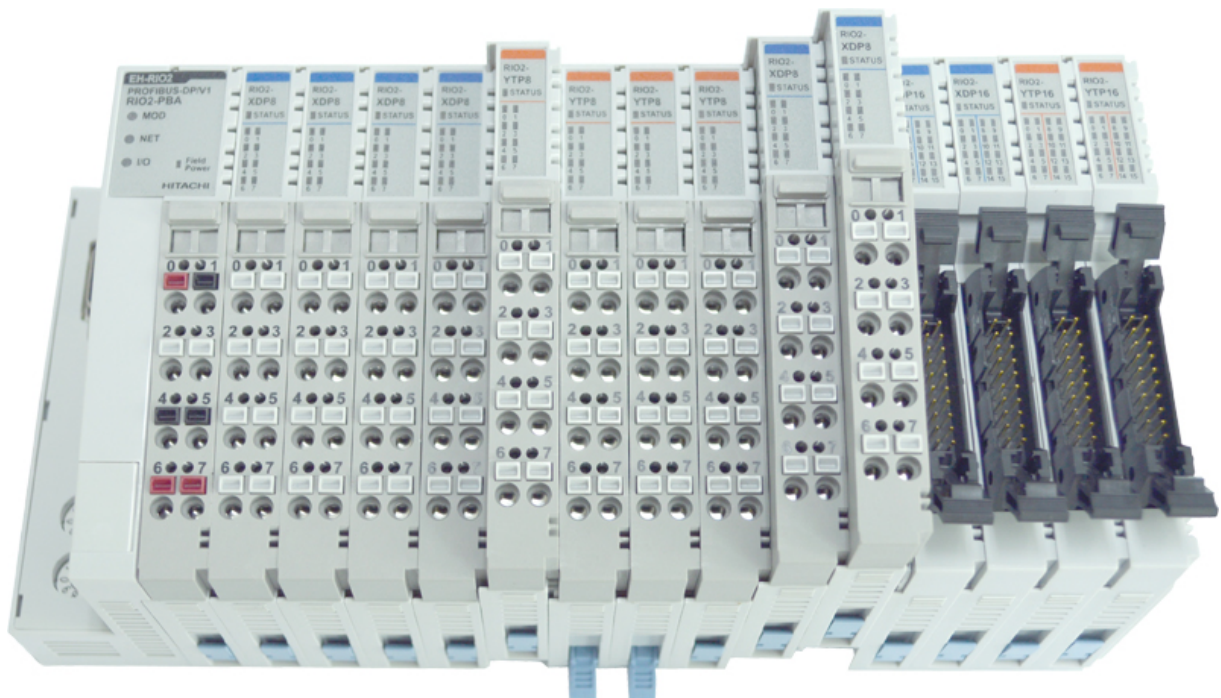

User Manual – High Speed Counter

DOCUMENT CHANGE SUMMARY				
REV	PAGE	REMARKS	DATE	EDITOR
1.06	New	Created	19.06.2015	Winter

User Manual – High Speed Counter

Table of Contents

1. Important Notes	1
1.1 Safety Instruction.....	2
1.1.1 Symbols.....	2
1.1.2 Safety Notes	2
1.1.3 Certification.....	2
2. HSC Input Module List	3
3. Specification	4
3.1 The Interface	4
3.1.1 RIO2-CU24	4
3.1.2 RIO2-CU24L	5
3.2 General Specification	6
4. Dimension.....	8
4.1 RIO2-CU24 / RIO2-CU24L	8
5. Configuration and Operational Function.....	9
5.1 RIO2-CU24.....	9
5.1.1 I/O Process Image Table	9
5.1.1.1 Input Image Data – 6byte.....	9
5.1.1.2 Output Image Data – 2byte	10
5.1.1.3 Configuration Parameter Table – 2byte.....	14
5.1.1.4 Memory Register Map.....	19
5.2 RIO2-CU24L.....	22
5.2.1 I/O Process Image Table	22
5.2.1.1 Input Image Data – 8byte.....	22
5.2.1.2 Output Image Data – 2byte	22
5.2.1.3 Configuration Parameter Data – 4byte	23
5.2.2 COUNT MODE	24
6. Trouble Shooting.....	26

User Manual – High Speed Counter

1. Important Notes

Solid state equipment has operational characteristics differing from those of electromechanical equipment. Safety Guidelines for the Application, Installation and Maintenance of Solid State Controls describes some important differences between solid state equipment and hard-wired electromechanical devices.

Because of this difference, and also because of the wide variety of uses for solid state equipment, all persons responsible for applying this equipment must satisfy themselves that each intended application of this equipment is acceptable.

In no event will Hitachi be responsible or liable for indirect or consequential damages resulting from the use or application of this equipment.

The examples and diagrams in this manual are included solely for illustrative purposes. Because of the many variables and requirements associated with any particular installation, Hitachi cannot assume responsibility or liability for actual use based on the examples and diagrams.

Warning!

- ✓ **If you don't follow the directions, it could cause a personal injury, damage to the equipment or explosion**
- Do not assemble the products and wire with power applied to the system. Else it may cause an electric arc, which can result into unexpected and potentially dangerous action by field devices. Arching is explosion risk in hazardous locations. Be sure that the area is non-hazardous or remove system power appropriately before assembling or wiring the modules.
- Do not touch any terminal blocks or IO modules when system is running. Else it may cause the unit to an electric shock or malfunction.
- Keep away from the strange metallic materials not related to the unit and wiring works should be controlled by the electric expert engineer. Else it may cause the unit to a fire, electric shock or malfunction.



Caution!

- ✓ **If you disobey the instructions, there may be possibility of personal injury, damage to equipment or explosion. Please follow below Instructions.**
- Check the rated voltage and terminal array before wiring. Avoid the circumstances over 55°C of temperature. Avoid placing it directly in the sunlight.
- Avoid the place under circumstances over 85% of humidity.
- Do not place Modules near by the inflammable material. Else it may cause a fire.
- Do not permit any vibration approaching it directly.
- Go through module specification carefully, ensure inputs, output connections are made with the specifications. Use standard cables for wiring.
- Use Product under pollution degree 2 environment.

User Manual – High Speed Counter

1.1 Safety Instruction

1.1.1 Symbols

<p>DANGER</p> 	<p>Identifies information about practices or circumstances that can cause an explosion in a hazardous environment, which may lead to personal injury or death property damage or economic loss.</p>
<p>IMPORTANT</p>	<p>Identifies information that is critical for successful application and understanding of the product</p>
<p>ATTENTION</p> 	<p>Identifies information about practices or circumstances that can lead to personal injury, property damage, or economic loss. Attentions help you to identify a hazard, avoid a hazard, and recognize the consequences.</p>

1.1.2 Safety Notes

<p>DANGER</p> 	<p>The modules are equipped with electronic components that may be destroyed by electrostatic discharge. When handling the modules, ensure that the environment (persons, workplace and packing) is well grounded. Avoid touching conductive components, e.g. FnBUS Pin.</p>
--	--

1.1.3 Certification

c-UL-us UL Listed Industrial Control Equipment, certified for U.S. and Canada

CE Certificate

EN 61000-6-2; Industrial Immunity

EN 61000-6-4; Industrial Emissions

LR / FCC

RoHS (EU, CHINA)

User Manual – High Speed Counter

2. HSC Input Module List

Number	Description	Remark
RIO2-CU24	1 Channel, High Speed Counter, 24V Input	
RIO2-CU24L	2 Channel, High Speed Counter, 24V Sink Input	

User Manual – High Speed Counter

3. Specification

3.1 The Interface

3.1.1 RIO2-CU24

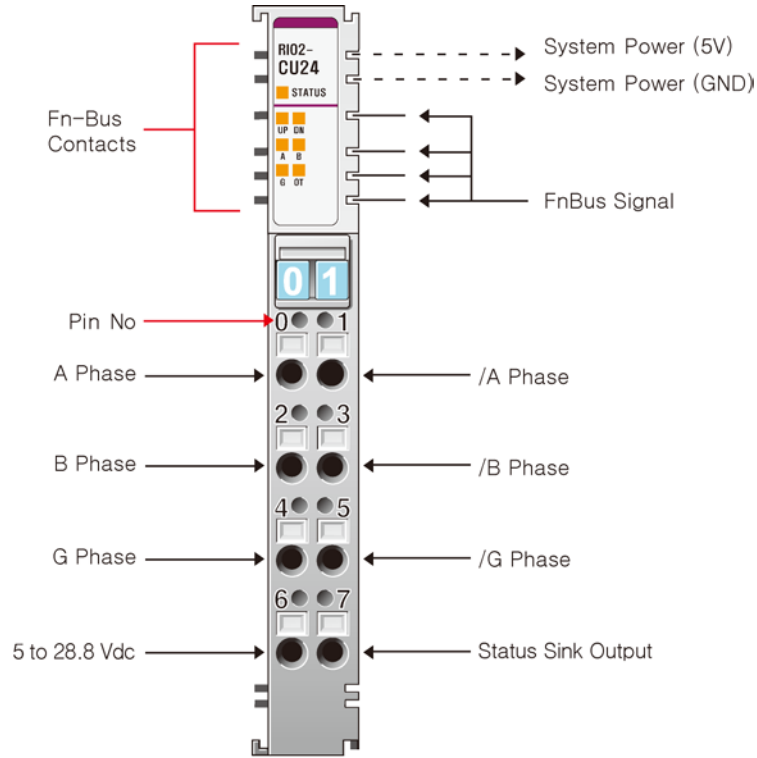

(1) Open Collector

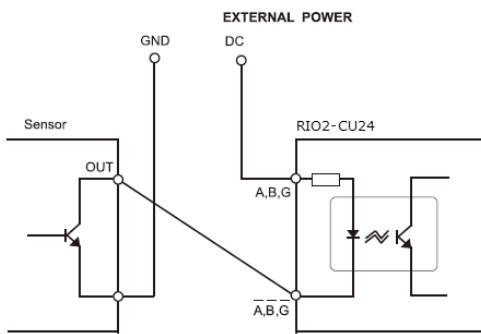

(2) VOLTAGE OUTPUT

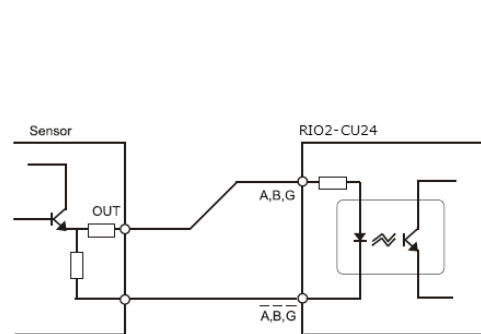

(3) LINE DRIVE

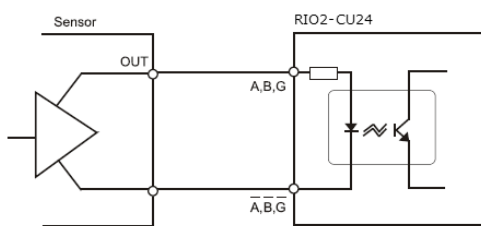

(4) SINK OUTPUT (STATUS)

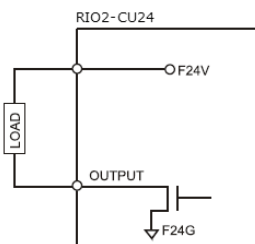

User Manual – High Speed Counter

3.1.2 RIO2-CU24L

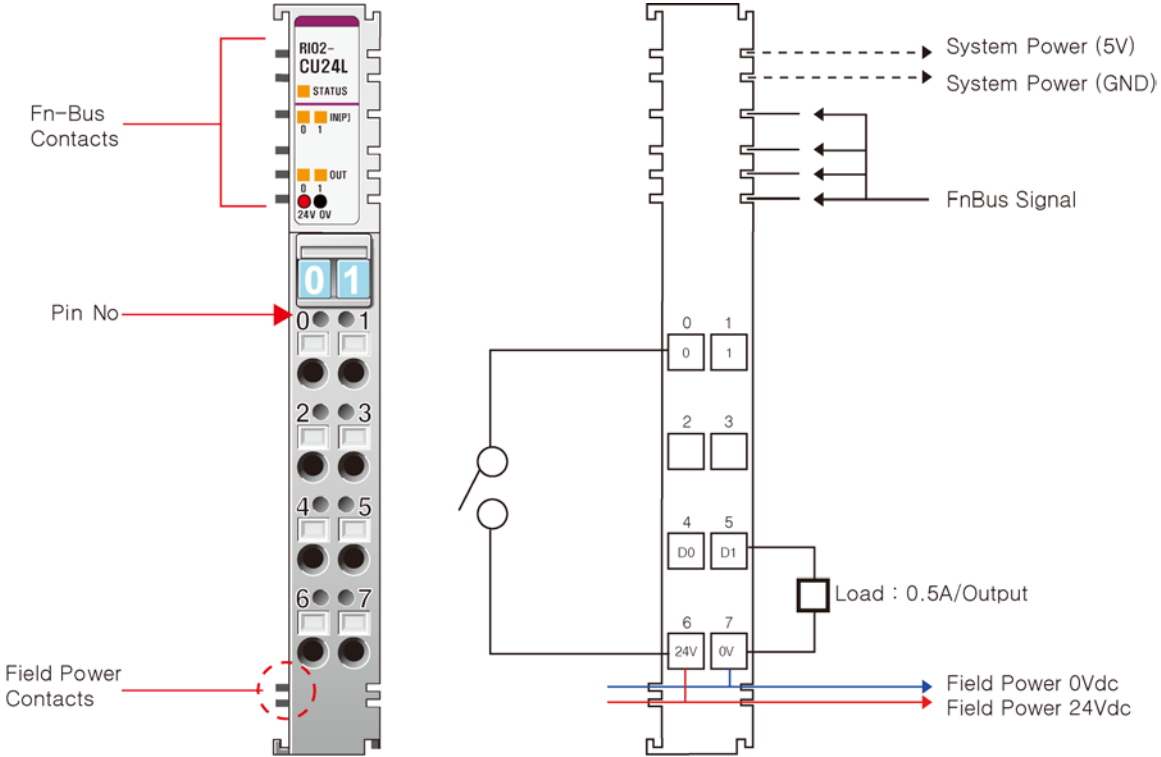

User Manual – High Speed Counter

3.2 General Specification

General Specification		
	RIO2-CU24	RIO2-CU24L
Input Specification		
Number of Channel	1 Channel 0-1 Group of A and /A(or GND) 2-3 Group of B and /B(or GND) 4-5 Group of G and /G(or GND)	Max 2 Channel
Indicators	1 Green/Red FnBus Status 2 Green Up/Down Status 3 Green Terminal Input LEDs 1 Green Terminal Output LED	1 Green/Red FnBus Status 2 Green Terminal Input LEDs
Input Voltage(Rated)	24Vdc	
Input Current	6.1mA@24Vdc	
Min. On-Status Volt/Current	12Vdc/2.9mA	
Max. Off-Status Volt/Current	1.8Vdc/0.15mA	7Vdc/1.0mA
Maximum Input Frequency	Max. 1.5MHz	Max.100KHz except Encoder x4 Max.50KHz Encoder x4
Input Duty Range	10%~90%	20%~80%
Input Filter Selections	Bypass 1usec 5usec 10usec 50usec 100usec 500usec 1msec 5msec 10msec	None
Counting Mode	1 Pulse Mode 2Pulse Mode Encoder x1 Encoder x2 Encoder x4 Period/Rate Mode PWM Output Mode	1-Input Mode – Up, Down 2-Input Mode – Up/Inhibit, Up/Reset, Down/Inhibit, Down/Reset, Up/Down, Clock/Direction, Encoder x1, Encoder x2, Encoder x4
Gate Function Mode	Store/Continue Store/Wait/Resume Store-Reset/Wait/Start Store-Reset/Start	None
Counter Size	24bit-wide	32bit-wide/Channel
Common Type	1 Common	2 Common
Output Specification		
Channel Type	1 Channel Sink Type	2 Channel Source Type
Output Voltage	5~28.8Vdc	24Vdc
Output Current	0.5A	0.5A/Channel, Short Protection

User Manual – High Speed Counter

Indicator	1 Green Status	2 Green Status
General Specification		
Power Dissipation	80mA@5.0Vdc	160mA@5.0Vdc
Isolation	I/O to Logic : Photo coupler Isolation	
Field Power	Supply Power : 24Vdc nominal Voltage Range : 18~28.8Vdc Power Dissipation : 20mA@24Vdc	
Wiring	I/O Cable Max/ 2.0mm ² (AWG#14)	
Weight	70g	
Module Size	12mm x 99mm x 70mm	
Environment Condition	Operating Temperature: -20°C ~ 55°C Non-Operation Temperature: -40°C ~ 85°C Relative Humidity : 5% ~ 95% non-condensing Operating Altitude : 2000m Shock Operating : 30G Shock Non-Operating : 50G Vibration : 2G@10-500Hz	Operating Temperature: -20°C ~ 55°C Non-Operation Temperature: -40°C ~ 85°C Relative Humidity : 5% ~ 90% non-condensing Operating Altitude : 2000m Shock Operating : 10G Shock Non-Operating : 30G Vibration : 2G@10-500Hz

User Manual – High Speed Counter

4. Dimension

4.1 RIO2-CU24 / RIO2-CU24L

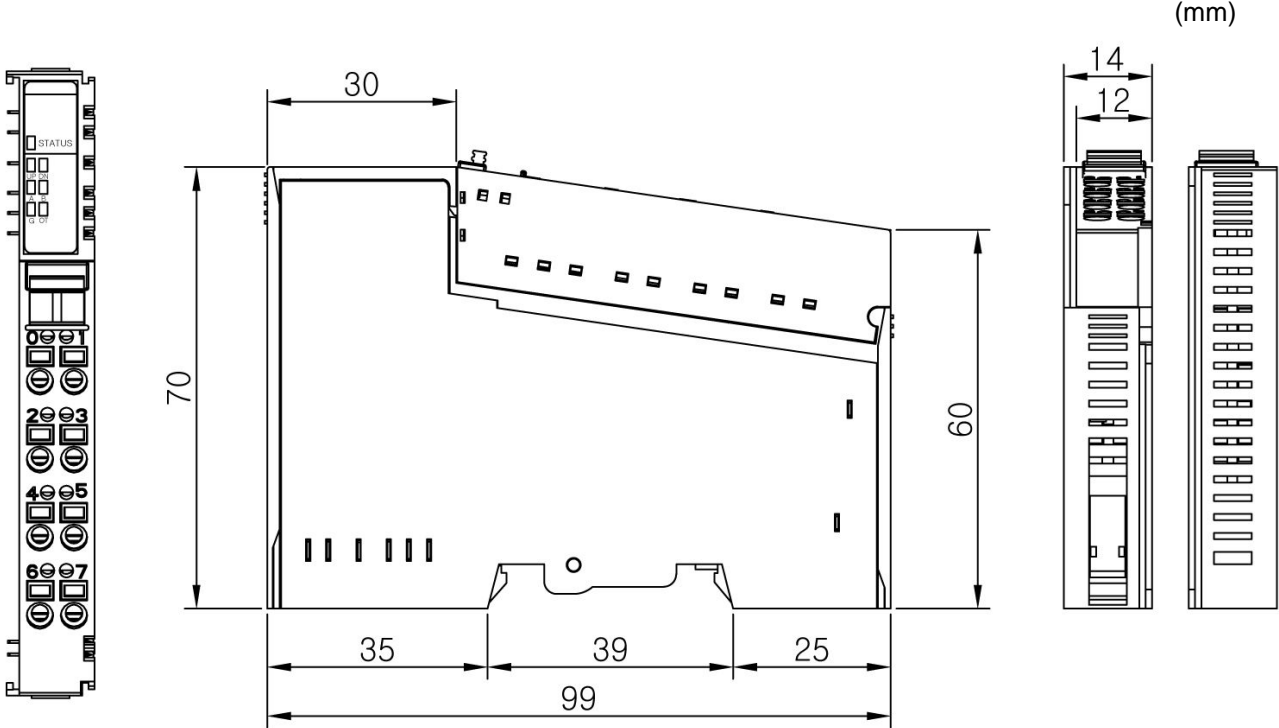

User Manual – High Speed Counter

5. Configuration and Operational Function

5.1 RIO2-CU24

5.1.1 I/O Process Image Table

5.1.1.1 Input Image Data – 6byte

Byte	Bit 7	Bit 6	Bit 5	Bit 4	Bit 3	Bit 2	Bit 1	Bit 0
0	Current Counter Value(Low) when IDS = 0 Current Counter Value(Low) when IDS = 1							
1	Current Counter Value(Middle) when IDS = 0 Current Counter Value(Middle) when IDS = 1							
2	Current Counter Value(High) when IDS = 0 Current Counter Value(High) when IDS = 1							
3	Always 0							
4	Status Low(compared flags)							
	0	0	SUF	SOF	SEQL(=)	SEQ(=)	SLT(<)	SGT(>)
5	Status High(same as LED flags)							
	0	0	SOT	SGIN	SBIN	SAIN	SDN	SUP

- Current Counter Value

The Current Counter Value is really counting value of incoming pulse.

The Current Counter Value can only read to binary number (0 to 16,777,215)

- Status Low (compared flags)

The Status Low can only read.

SUF: Status Underflow (Latched)

SOF: Status Overflow (Latched)

SEQL (=): Status Current count value = Compare count value (Latched)

SEQ (=): Status Current count value = Compare count value (Unlatched)

SLT (<): Status Current count value < Compare count value (Unlatched)

SGT (>): Status Current count value > Compare count value (Unlatched)

- Status High (same as LED display)

The Status High can only read.

SUP: Status Counter Up

SDN: Status Counter Down

SAIN: Status A Terminal Input

SBIN: Status B Terminal Input

SGIN: Status G Terminal Input

SOT: Status Output Terminal (same as OT)

User Manual – High Speed Counter

5.1.1.2 Output Image Data – 2byte

Byte	Bit 7	Bit 6	Bit 5	Bit 4	Bit 3	Bit 2	Bit 1	Bit 0	
0	Status Output Terminal (OT) Control								
	Status Output Terminal Selection "0000" : Force Off "0001" : GT "0010" : LT "0011" : EQ "0101" : Overflow "0110" : Underflow "1001" : Count Up "1010" : Count Down "1011" : A Terminal Input "1100" : B Terminal Input "1101" : G Terminal Input "1110" : PWM Output "1111" : Force On Others : Force Off				Status Output Terminal Pulse Width "0000" : Bypass "0001" : 1msec "0010" : 5msec "0011" : 10msec "0100" : 20msec "0101" : 50msec "0110" : 100msec "0111" : 200msec "1000" : 500msec "1111" : Latched Others : Bypass				
1	Command or PWM Duty value (PWM Output Mode)								
	Command	7	6	5	4	3	2	1	0
	PWM duty value	HRST	CR	CP	CST	PU	PO	PE	IDS
		0~100dec (= 0~100%)							

- Status Output Terminal (OT) Control

This Status Output Terminal Control can read and write to binary.

Below example is output overflow flag in Status Register. When Status flag is the rising, Status Output Terminal Pulse Width is waiting by user setting value until.

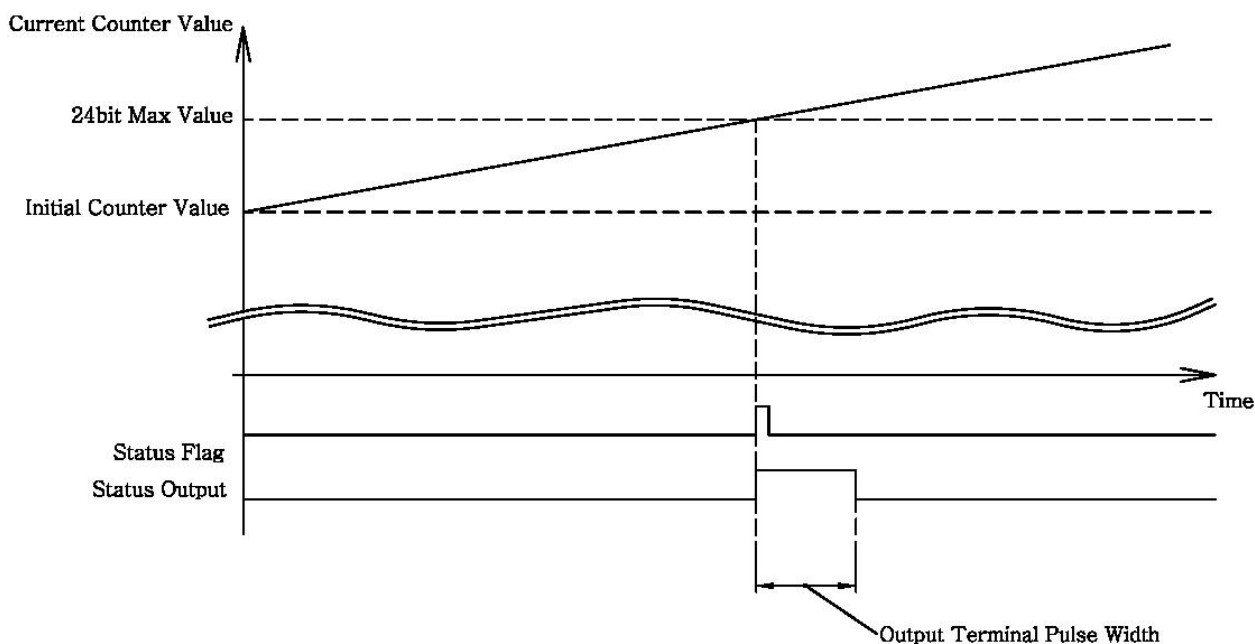

User Manual – High Speed Counter

- Command or PWM duty value (PWM Output Mode)

This 1byte register can use to Command or PWM duty value control. The Command control is used to general and if Gate Function/Counter Mode set to PWM Output Mode, this register is a variable of PWM output duty value.

- When used Command

This register can control by user.

This register used to read and write of binary number (8bit).

- IDS: Input data selection (0: Current counter value, 1: Store counter value)

- PE: Process Equal

When Current counter value = Compare counter value, Current count value is setting to Initial counter value.

Below example picture shows timing waveforms of Process Equal.

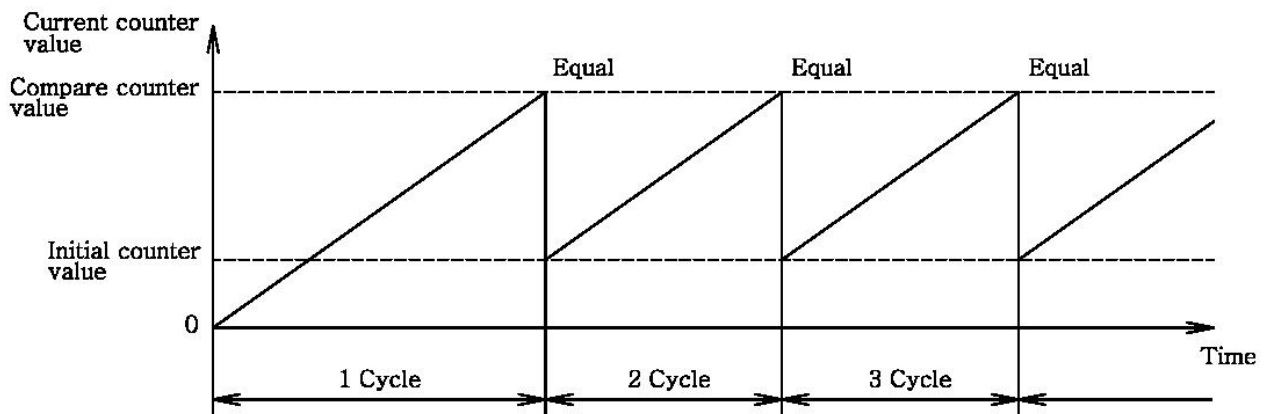

- PO: Process Underflow

When current counter value is overflow. Current count value is setting to Initial counter value. Below example picture shows timing waveforms of Process Overflow.

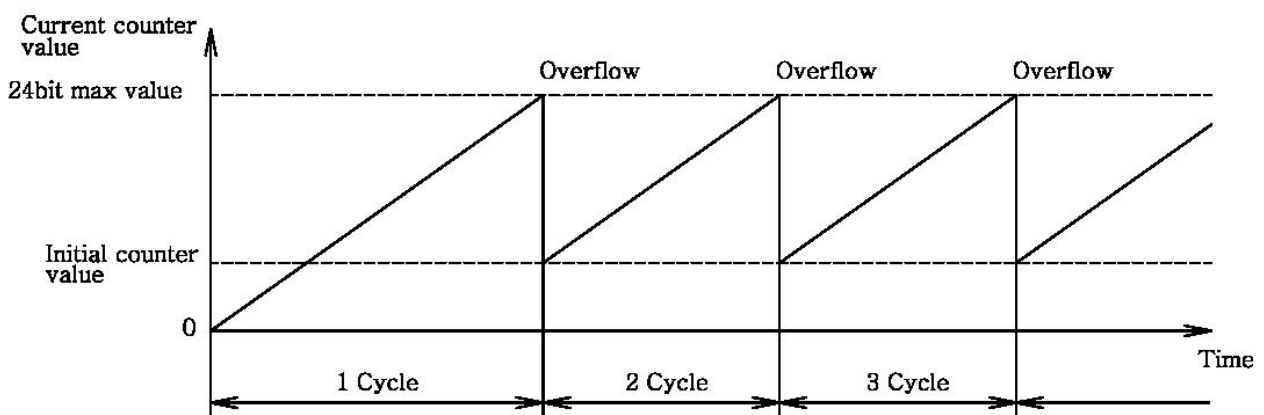

User Manual – High Speed Counter

- PU: Process Underflow

When Current counter value is underflow, Current count value is setting to Initial counter value. Below example picture shows timing waveforms of Process Underflow.

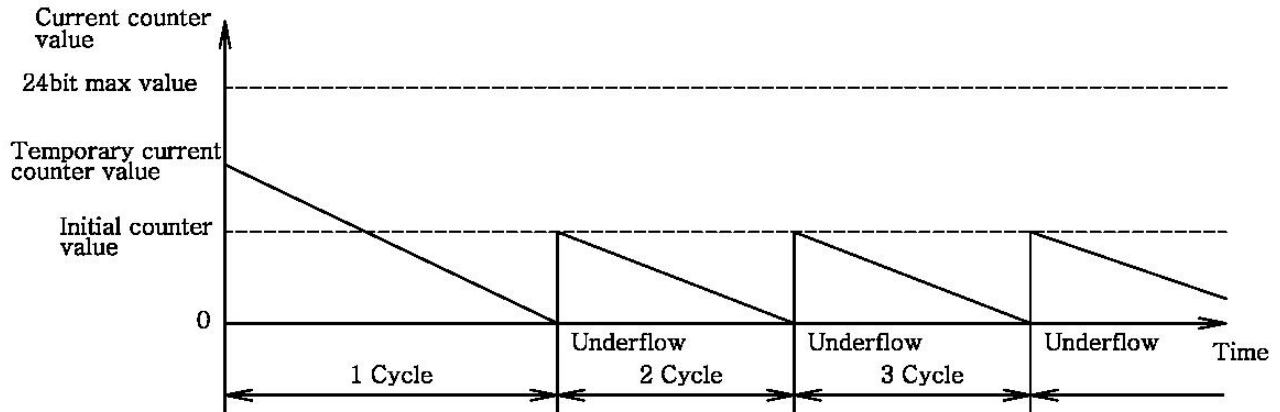

- CST: Clear Status (SOT, SUF, SOF, SEQL)

- CP: Counter Preset, Current counter value = Initial counter value

- CR: Counter Reset, Current counter value = 0

- HRST: Reset current counter value, stored counter value and Stats

◦ When used PWM duty value

When Counter Mode set to PWM Output Mode, this register can used to PWM duty value.

PWM Duty = 0 ~ 100 (= 0 ~ 100%). If >100 then 100%.

Below graphic is an error rate of duty (when Duty 50% and load 11KΩ).

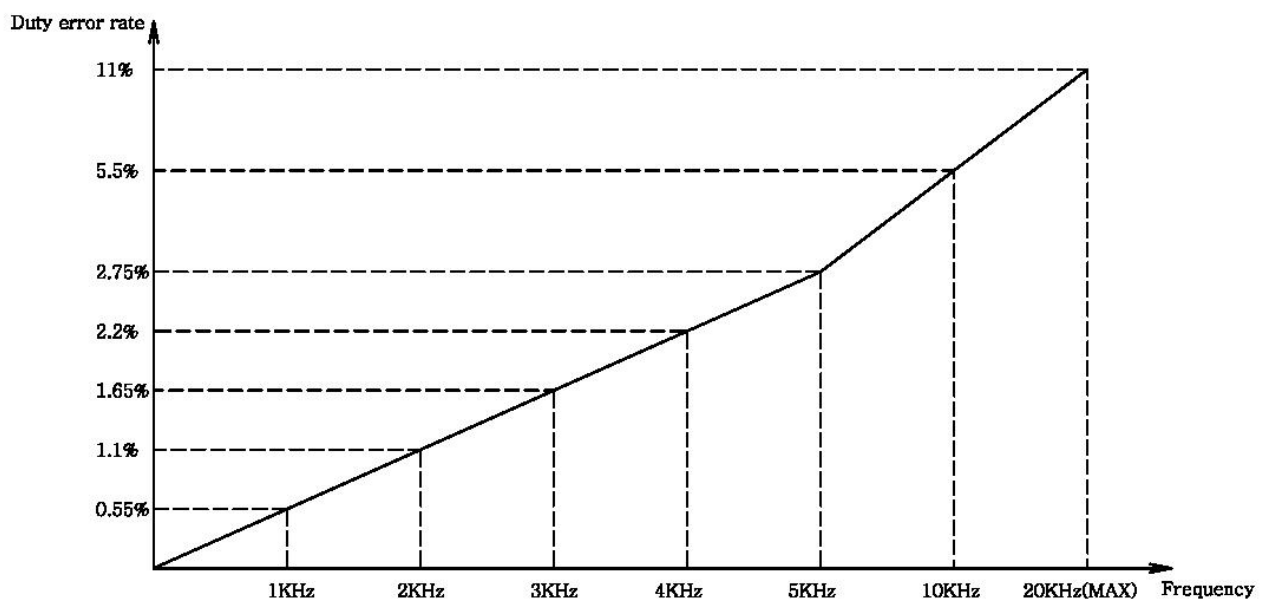

User Manual – High Speed Counter

See the PWM Mode in Gate Function/Counter Mode

Below example picture shows PWM waveforms about PWM duty value.

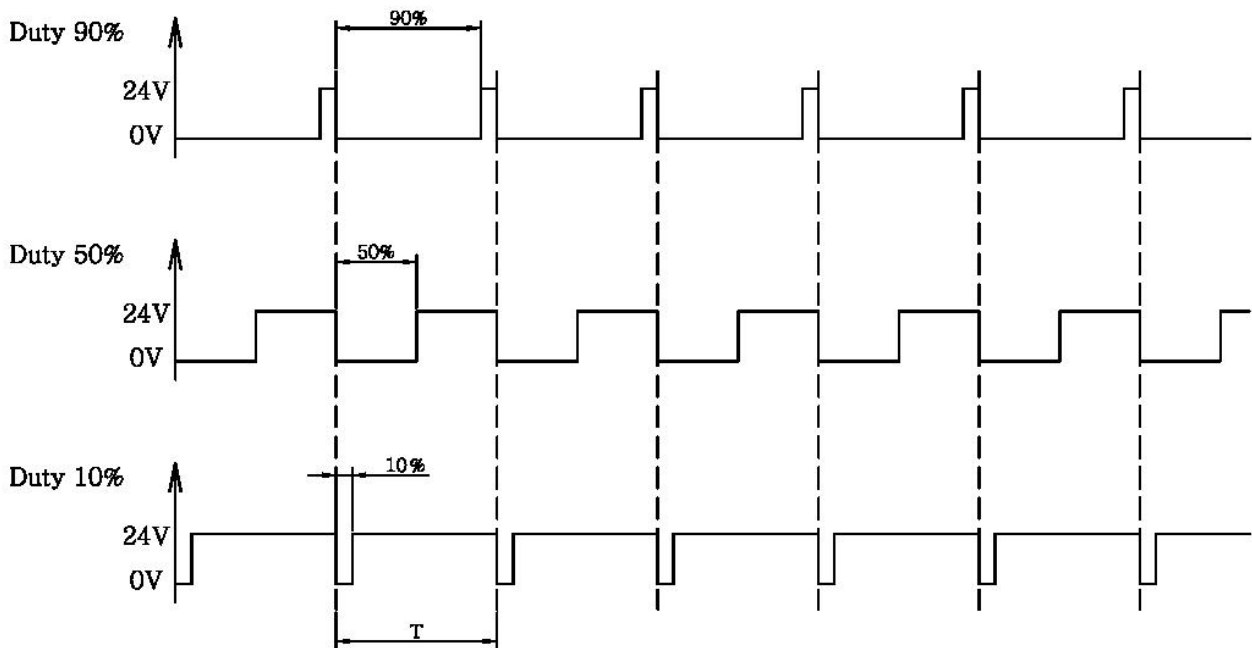

T = Time (If Frequency = 10 KHz then T= 0.1ms)

User Manual – High Speed Counter

5.1.1.3 Configuration Parameter Table – 2byte

Byte	Bit 7	Bit 6	Bit 5	Bit 4	Bit 3	Bit 2	Bit 1	Bit 0
0	Counter Mode / Gate Function							
	Gate Function "0000" : Gate Function Disabled "0001" : Store/Continue "0010" : Store/Wait/Resume "0011" : Store-Reset/Wait/Start "0100" : Store-Reset/Start Others : Gate Function Disabled				Count Mode "0000" : Counter Disabled "0001" : 1Pulse Mode "0010" : 2Pulse Mode "0011" : Encoder x1 "0100" : Encoder x2 "0101" : Encoder x4 "0110" : Period/Rate Mode "0111" : reserved "1000" : PWM Output Mode "1001" : reserved Others : Counter Disable			
1	Input Filter / Gate Sampling Time							
	Gate Sampling Time "0000" : (10/1)MHz (0.1usec) "0001" : (10/2)MHz (0.2usec) "0010" : (10/4)MHz (0.4usec) "0011" : (10/8)MHz (0.8usec) "0100" : (10/16)MHz (1.6usec) "0101" : (10/32)MHz (3.2usec) "0110" : (10/64)MHz (6.4usec) "0111" : (10/128)MHz (12.8usec) Others : (10/1)MHz (0.1usec)				Input Filter "0000" : Bypass(about 1.5MHz) "0001" : 1usec (500KHz±30%) "0010" : 5usec (100KHz±30%) "0011" : 10usec (50KHz±30%) "0100" : 50usec (10KHz±30%) "0101" : 100usec (5KHz±30%) "0110" : 500usec (1KHz±30%) "0111" : 1msec (500Hz±30%) "1000" : 5msec (100Hz±30%) "1001" : 10msec (50Hz±30%) Others : Bypass(about 1.5MHz)			

IMPORTANT

Configuration Parameter can only be used to explicit message.
Refer Explicit Message table in Network Adapter manual.

- Gate Function/Counter Mode (Parameter Byte #0)

- Counter Mode

- 1 Pulse Mode (A: Pulse, B: Direction)

The 1 Pulse Mode reads incoming pulses and returns a binary number (0 to 16,777,215) to FnBus. The 1 Pulse Modes accepts only one-phase inputs. The module determines the Phase B input status to up or down count.

(B Phase = High: Down Counter, B Phase = Low: Up Counter)

Below example picture shows timing waveforms of 1 Pulse Method Pulse Mode.

User Manual – High Speed Counter

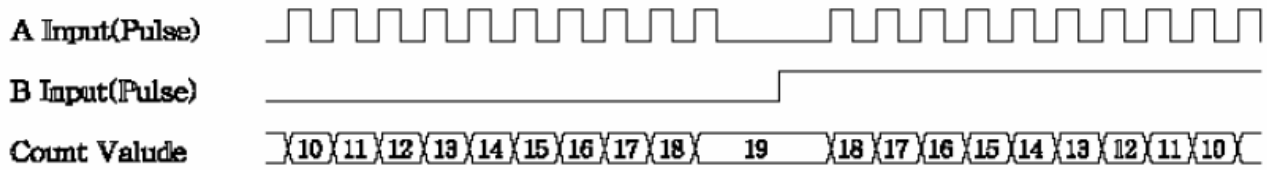

- 2 Pulse Mode (A: Up Pulse, B: Down Pulse)

The 2 Pulse Mode reads incoming pulses and returns a binary (0 to 16,777,215) to FnBus. The 2 Pulse Modes only accepts 2 Phase input. If A Phase reads incoming pulse and B Phase low, the time is up count state.

Below example picture shows timing waveforms of Pulse 2 Pulse Mode.

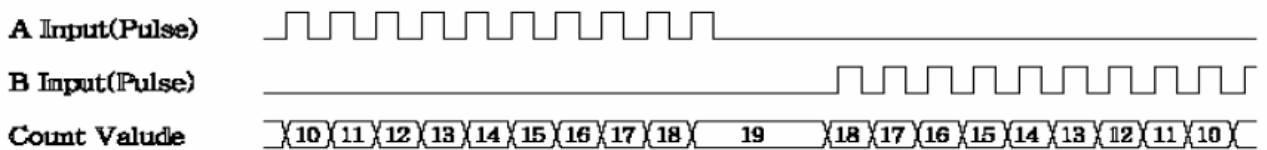

- Encoder x1 (A: Aph, B: Bph)

The Encoder x1 reads incoming pulse and returns number (0 to 16,777,215) to the FnBus. The Encoder x1 only accepts 2 Phase quadrature (90°) input. The mode senses the relationship between the 2 Phase, and counts up or down accordingly.

Below example picture shows timing waveforms of Encoder x1.

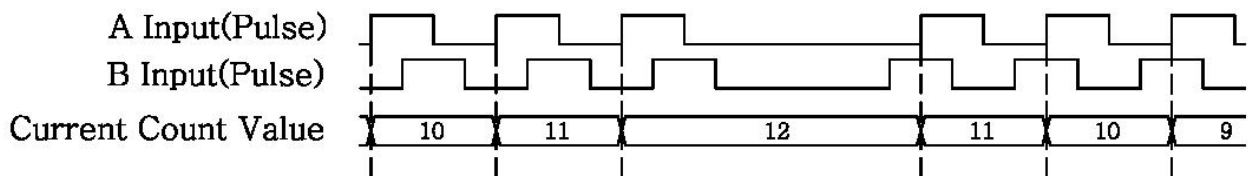

- Encoder x2 (A: Aph, B: Bph)

The Encoder x2 reads incoming pulse and returns number (0 to 16,777,215) to the FnBus. The Encoder x2 only accepts 2 Phase quadrature (90°) input. The mode senses the relationship between the 2 Phase, and counts up or down accordingly.

Below example picture shows timing waveforms of Encoder x2.

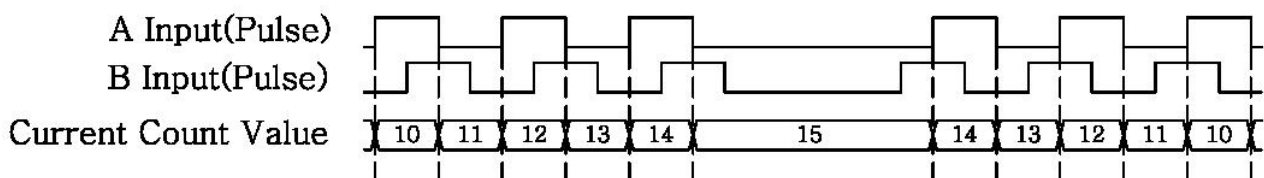

User Manual – High Speed Counter

- Encoder x4 (A: Aph, B: Bph)

The Encoder x4 reads incoming pulse and returns number (0 to 16,777,215) to the FnBus. The Encoder x4 only accepts 2 Phase quadrature (90°) input. The mode senses the relationship between the 2 Phase, and counts up or down accordingly.

Below example picture shows timing waveforms of Encoder Mode x4.

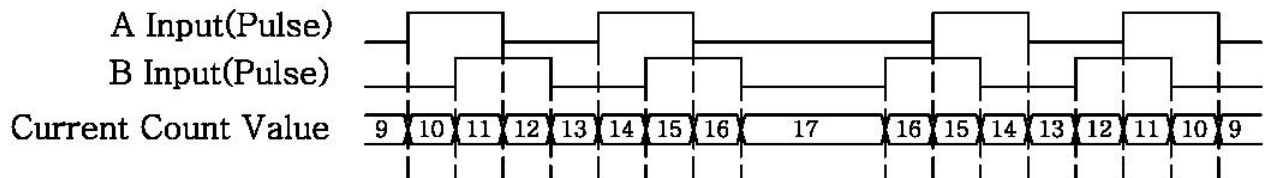

- Period/Rate Mode (Gate Function Disabled)

The Period/Rate Mode will return an incoming frequency and total Current Count Value to the FnBus, by gating an Internal Sampling Clock with an external signal.

This mode determines the frequency and total number of input pulses by incoming the number of internal sample clock over a user-specified number of input signal pulses. At the end of the specified number of pulses, the module returns the frequency. When the frequency is updated, both outputs are checked against their associated presets.

Below example picture shows timing waveforms of Period/Rate Mode.

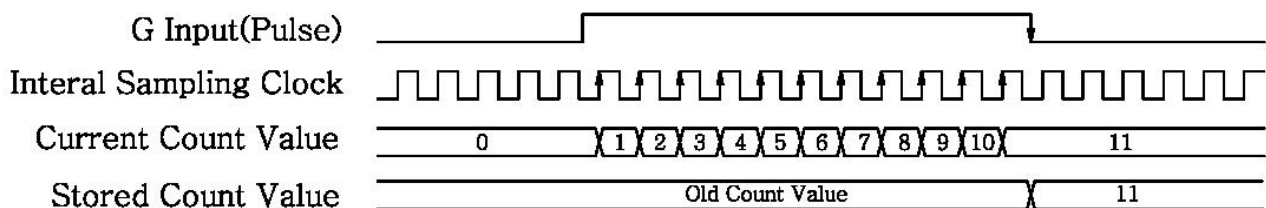

- PWM (Pulse Width Modulation) Output Mode

The PWM Output Mode uses the Current counter value to generate a continuous rolling sequence of numbers.

The configurations of PWM range value have to a frequency (1 to 20 KHz) and duty cycle (0 to 100%). The PWM output can be used to direct the PWM signal to terminal output.

Below example picture shows timing waveforms of PWM Output Mode.

User Manual – High Speed Counter

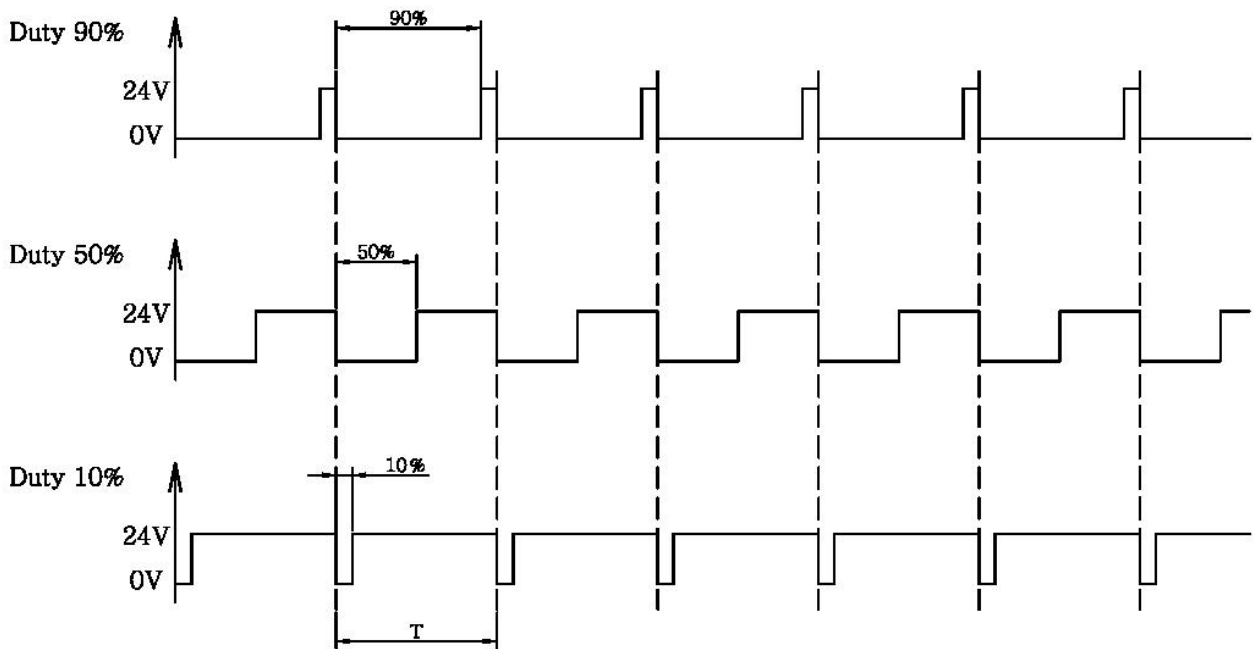

◦ Gate Function Mode

This Gate Function will operate in one of five modes (Store/Continue, Store/Wait/Resume, Store-Reset/Wait/ and Store-Reset/Start). The Gate Function was unused to Period /Rate.

- Store/Continue

When G ph are raising edge, The Stored Count Value register will get counting value by Current Count Value register. Next Current Count Value will do counting continue.

Below example picture shows timing waveforms of Store/Continue.

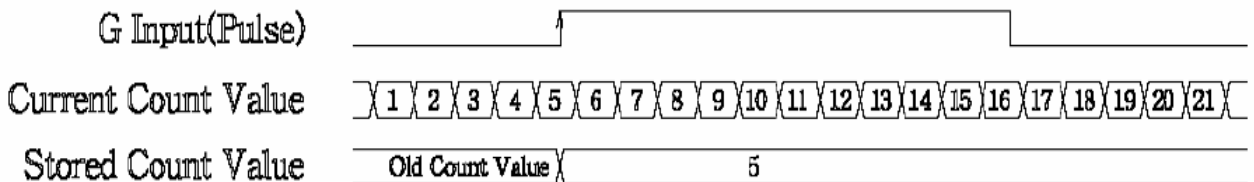

- Store/Wait/Resume

When G Ph are rising edge, The Stored Count Value register will get counting value by Current Count Value register and waits the Current Count Value until falling edge. Next G Ph will be falling edge and Current Count Value register resume counting.

Below example picture shows timing waveforms of Store/Wait/Resume.

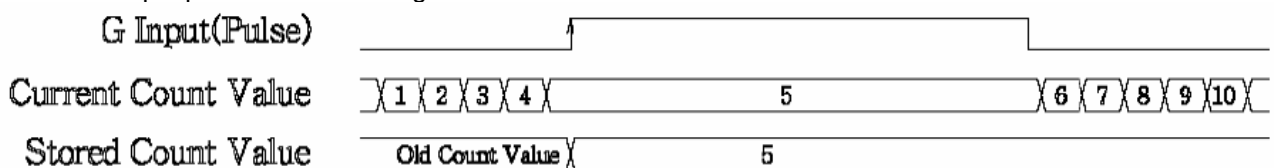

User Manual – High Speed Counter

- Store-Reset/Wait/Start

When G Ph are rising edge, The Stored Count Value register will get counting value by Current Count Value register and Current Count Value register reset at the same time. The Current Count Value register wait until G Ph falling edge. Next Current Count Value register start counting.

Below example picture shows timing waveforms of Store-Reset/Wait/Start.

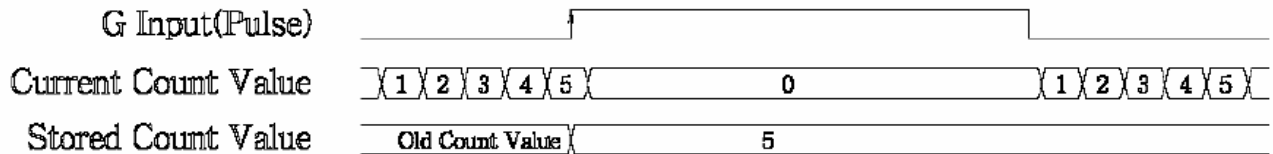

- Store-Reset/Start

When G Ph are rising edge, The Stored Count Value register will get counting value by Current Count Value register and Current Count Value register reset at the same time and the register start counting.

Below example picture shows timing waveforms of Store-Reset/Start.

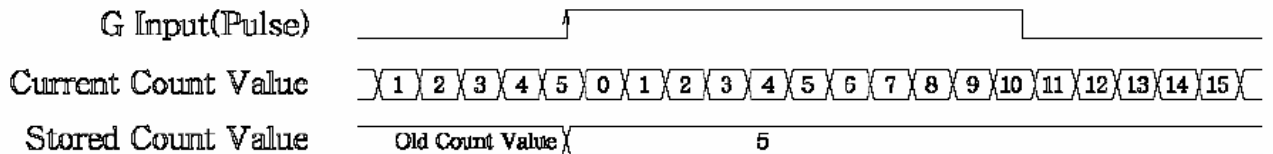

- Gate Sampling Time/Input Filter (Parameter Byte #1)

This Gate Sampling Time/Input Filter can read and write to binary.

FnIO-HSC-5101 module has low path filter which can control by Input Filter (0 to 4bit) value. When Input Filter is 1usec sampling, the filtering principle shows below picture. The sampled the number of time can third more. Otherwise Input pulse be erasing with below sample picture. If Input Filter is setting to 5usec ("0010"), passing frequency is 0 ~ 100Hz.

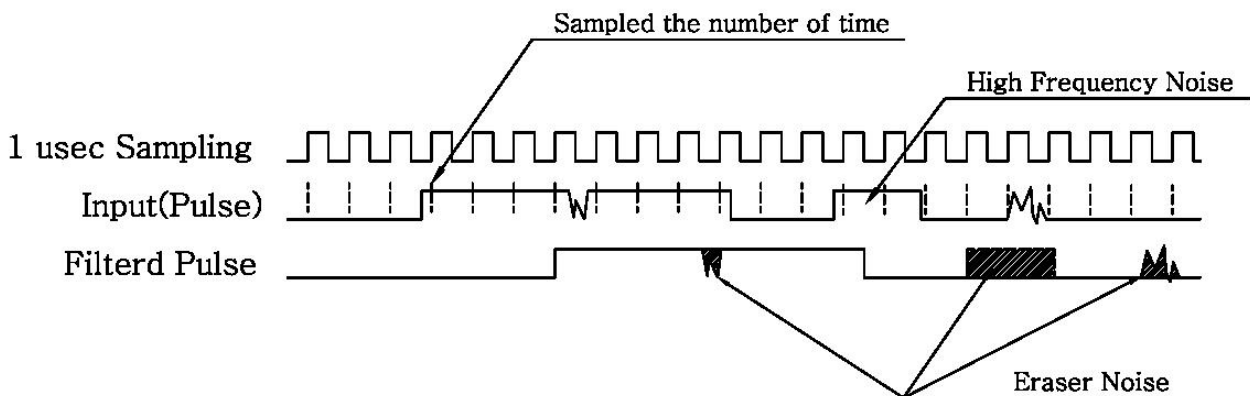

When this register used to Period/Rate mode, Internal Sampling Clock set frequency.

User Manual – High Speed Counter

5.1.1.4 Memory Register Map

Byte Offset	Access	Description	Default Value
0	R	Current count value(Low byte) (Input Data Byte#0)	0x00
1	R	Current count value(Middle byte) (Input Data Byte#1)	0x00
2	R	Current count value(High byte) (Input Data Byte#2)	0x00
3	R	Always 0 (Input Data Byte#3)	0x00
4	R	Status Low(compared flags) (Input Data Byte#4)	0x00
5	R	Status High(same as LED display) (Input Data Byte#5)	0x00
6	R	Output Terminal(OT) Control (Output Data Byte#0)	0x00
7	R	SSR(Special Selection Register) (Output Data Byte#1)	0x00
8	R/W	Gate Function/Counter Mode (Parameter Byte#0)	0x00
9	R/W	Gate Sampling Time/Input Filter (Parameter Byte#1)	0x00
10	R/W	Don't care	0x00
11	R/W	Don't care	0x00
12	R	Stored count value(Low Byte) (Input Data Byte#0)	0x00
13	R	Stored count value(Middle Byte) (Input Data Byte#1)	0x00
14	R	Stored count value(High Byte) (Input Data Byte#2)	0x00
15	R	Always 0 (Input Data Byte#3)	0x00
16	R/W	Initial Counter Value(Low Byte) (Initial counter or PWM Frequency value)	0x00
17	R/W	Initial Counter Value(Middle Byte) (Initial counter or PWM Frequency value)	0x00
18	R/W	Initial Counter Value(High Byte) (Initial counter or PWM Frequency value)	0x00
19	R/W	Always 0	0x00
20	R/W	Compare count value(Low Byte)	0x00
21	R/W	Compare count value(Middle Byte)	0x00
22	R/W	Compare count value(High Byte)	0x00
23	R/W	Always 0	0x00

IMPORTANT

Some Memory Registers can only be used to explicit message.
Refer Explicit Message table in Network Adapter manual.

User Manual – High Speed Counter

- Stored counter value Register

This register can only return to 24bit binary number (0 to 16,777,215).

This register used to Period/Rate and Gate Counter mode.

- Initial Counter Value

This 4byte register can do use to Initial counter or PWM Frequency value control. The Initial counter value is used to general configuration the Current counter value and if Gate Function/Counter Mode set to PWM Output Mode, this register is a variable of PWM output frequency value.

- General configuration for initial current counter

RIO2-CU24 Module exist Initial counter value for starting of Current count value.

Current count value begins starting from Initial counter value.

User can configuration of Initial counter value.

If user can't configuration of Initial counter value, that is fixed to value (0x000000).

This Initial counter value used to PO, PU and PE.

This Initial counter value can reading and writing to binary number (0 to 16,777,215).

- Setting PWM Frequency value

If Gate Function/Counter Mode set to PWM Output Mode, this register is frequency value of PWM output

PWM Frequency = 1 ~ 20000 (=1Hz~20 KHz). If PWM Frequency value

< 1 then off, if PWM Frequency value > 20000 then 20 KHz

Below example picture shows timing waveforms of PWM Output Mode.

* When Frequency 1KHz and Duty 50%

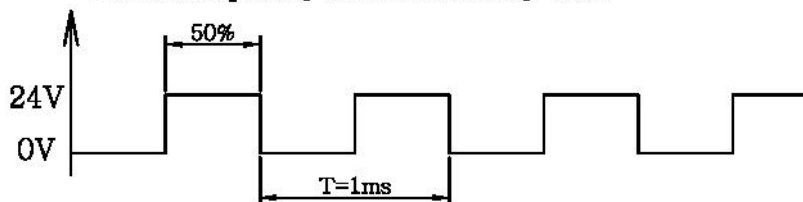

* When Frequency 2KHz and Duty 50%

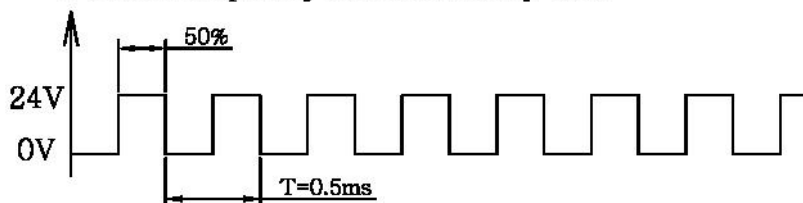

User Manual – High Speed Counter

- Compare counter value

Model RIO2-CU24 is equipped with Module Compare counter value to compare with Current Count Value

Status does transformation by compare value of Current Count Value and Compare Value Set Register.

Compare counter value used to comparison Current Counter value for Status.

If user can't configuration of Compare counter value, that is fixed to value (0x000000).

This register use to PO, PU, PE and Status output.

This register can reading and writing to binary number (0 to 16,777,215).

User Manual – High Speed Counter

5.2 RIO2-CU24L

5.2.1 I/O Process Image Table

5.2.1.1 Input Image Data – 8byte

Byte	Bit 7	Bit 6	Bit 5	Bit 4	Bit 3	Bit 2	Bit 1	Bit 0
0	Counter Value Ch#0 LL							
1	Counter Value Ch#0 LH							
2	Counter Value Ch#0 HL							
3	Counter Value Ch#0 HH							
4	Counter Value Ch#1 LL							
5	Counter Value Ch#1 LH							
6	Counter Value Ch#1 HL							
7	Counter Value Ch#1 HH							

- Counter Value Ch#0~1 is a 32bit-wide data.

5.2.1.2 Output Image Data – 2byte

Byte	Bit 7	Bit 6	Bit 5	Bit 4	Bit 3	Bit 2	Bit 1	Bit 0
0	CR0	CS0	DO1	DO0	CountMode0(refer CountMode Table)			
1	CR1	CS1	----	----	CountMode1(refer CountMode Table)			

- CR0, 1: Counter Reset for Ch#0, 1
- CS0, 1: Counter Stop (Inhibit Input) for Ch#0, 1
- DO0, 1: Digital Output for Output Ch#0, 1
- CountMode0, 1 Count Mode for: Ch#0, 1

User Manual – High Speed Counter

- CountMode Table

1/2 Input	Value	Count Mode	Description
1-Input Mode	B'0000 (0x0)	Up Clock	Counter Input Ch#0~1 act as Up Clock to Ch#0~1
	B'0001 (0x1)	Down Clock	Counter Input Ch#0~1 act as Down Clock to Ch#0~1
	B'0010 (0x2)	-----	-----
	B'0011 (0x3)	-----	-----
2-Input Mode	B'0100 (0x4)	Up Clock & Inhibit	If CountMode0=0x4, CountMode1 is not used. - Counter Input Ch#0 acts as Up Clock Input to Ch#0 - Counter Input Ch#1 acts as Inhibit Input to Ch#0
	B'0101 (0x5)	Up Clock & Reset	If CountMode0=0x5, CountMode1 is not used. - Counter Input Ch#0 acts as Up Clock Input to Ch#0 - Counter Input Ch#1 acts as Reset Input to Ch#0
	B'0110 (0x6)	Down Clock & Inhibit	If CountMode0=0x6, CountMode1 is not used. - Counter Input Ch#0 acts as Down Clock Input to Ch#0 - Counter Input Ch#1 acts as Inhibit Input to Ch#0
	B'0111 (0x7)	Down Clock & Reset	If CountMode0=0x7, CountMode1 is not used. - Counter Input Ch#0 acts as Down Clock Input to Ch#0 - Counter Input Ch#1 acts as Reset Input to Ch#0
	B'1000 (0x8)	Up Clock & Down Clock	If CountMode0=0x8, CountMode1 is not used. - Counter Input Ch#0 acts as Up Clock Input to Ch#0 - Counter Input Ch#1 acts as Down Clock Input to Ch#0
	B'1001 (0x9)	Clock & Direction	If CountMode0=0x9, CountMode1 is not used. - Counter Input Ch#0 acts as Clock Input to Ch#0 - Counter Input Ch#1 acts as Direction Input to Ch#0
	B'1010 (0xA)	Encoder 1x	If CountMode0=0xA, CountMode1 is not used. - Counter Input Ch#0 acts as A phase Input to Ch#0 - Counter Input Ch#1 acts as B phase Input to Ch#0
	B'1011 (0xB)	Encoder 2x	If CountMode0=0xB, CountMode1 is not used. - Counter Input Ch#0 acts as A phase Input to Ch#0 - Counter Input Ch#1 acts as B phase Input to Ch#0
	B'1100 (0xC)	Encoder 4x	If CountMode0=0xC, CountMode1 is not used. - Counter Input Ch#0 acts as A phase Input to Ch#0 - Counter Input Ch#1 acts as B phase Input to Ch#0
	B'1101 (0xD)	-----	-----
	B'1110 (0xE)	-----	-----
	B'1111 (0xF)	-----	-----

- If CountMode0 is 2-Input Mode, CountMode1 and Counter Input Ch#0 do not affect Counter Value Ch#1.
- Do not assign 2-Input Mode to CountMode1
- Refer 5.2.2 COUNT MODE for details,

5.2.1.3 Configuration Parameter Data – 4byte

Byte	Bit 7	Bit 6	Bit 5	Bit 4	Bit 3	Bit 2	Bit 1	Bit 0
0	Reserved							
1	Reserved							
2	Reserved							
3	Reserved							

User Manual – High Speed Counter

5.2.2 COUNT MODE

Up Clock (0x0)



Down Clock (0x1)



Up Clock & Inhibit

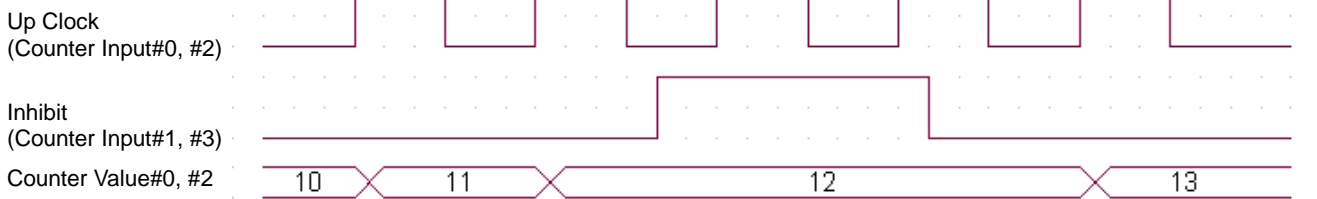

Up Clock & Reset

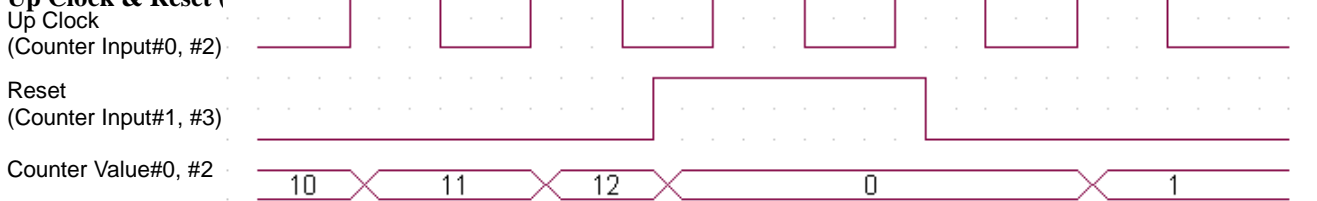

Down Clock & Inhibit (0x6)

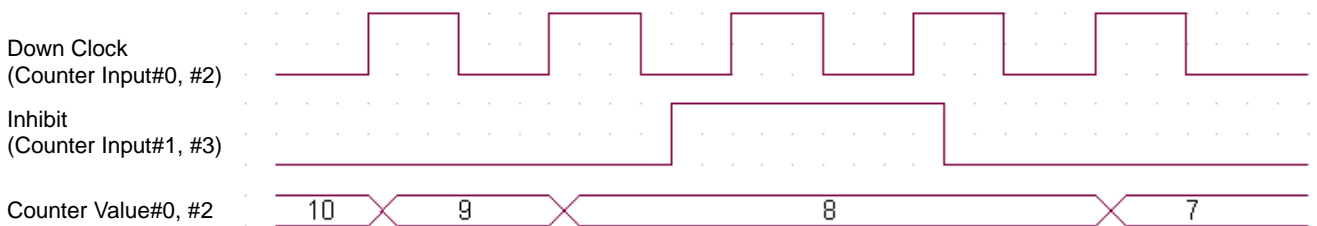

Down Clock & Reset (0x7)

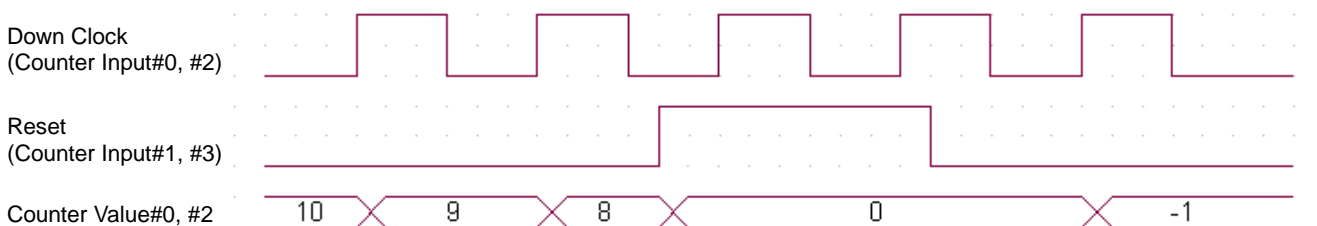

User Manual – High Speed Counter

Up Clock & Down Clock (0x8)

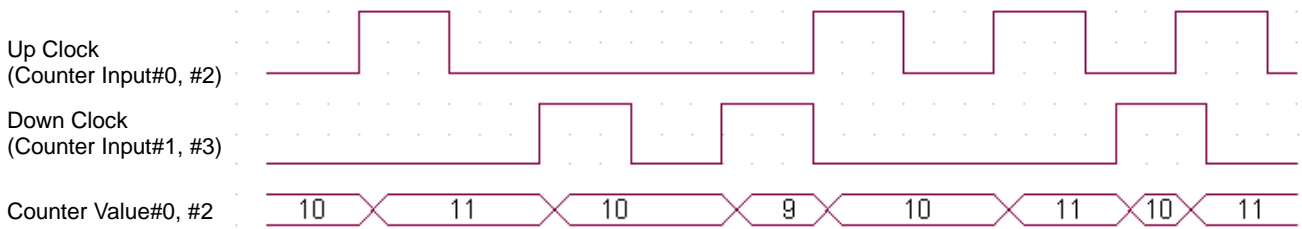

Clock & Direction (0x9)

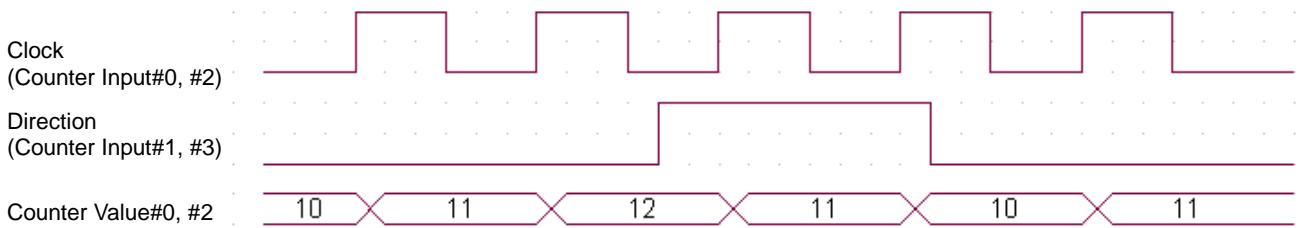

Encoder 1x (0xA)

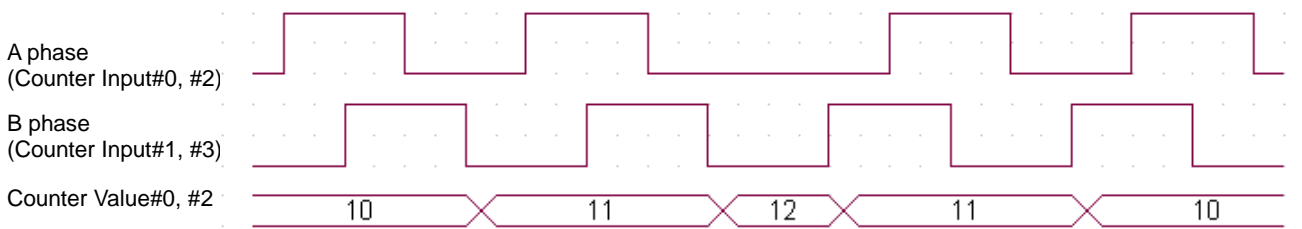

Encoder 2x (0xB)

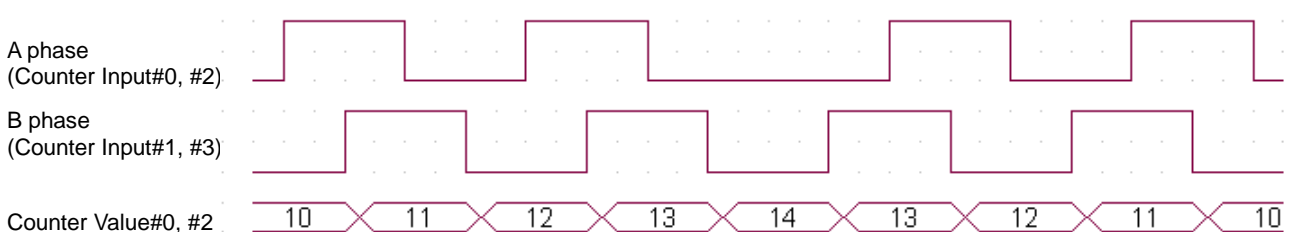

Encoder 4x (0xC)

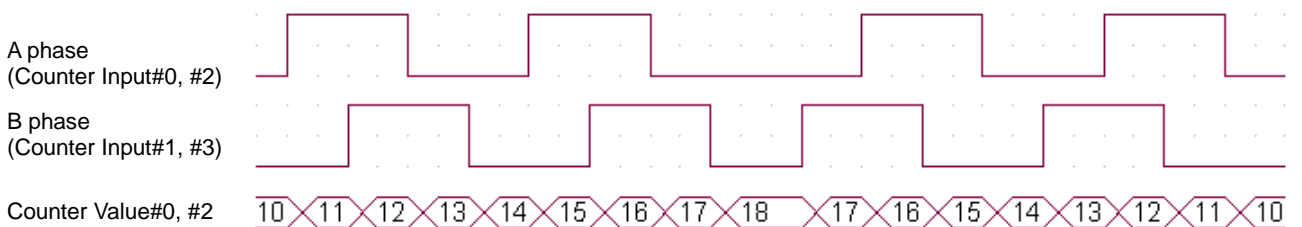

User Manual – High Speed Counter

6. Trouble Shooting

<p>ATTENTION</p> 	<p>In this manual, it couldn't be described all variety case with Network Adapter of several protocols. So if you couldn't find any fault after investigating all below cases, refer to RIO2 user manual.</p>
---	---

LED Status	Cause	Action
All LED turns off	-No power	-Check main power Cable
	-System power is not supplied.	-Contact Sales team and send module for repair.
STATUS LED flashes red	<ul style="list-style-type: none"> -Excess of expansion slot - Excess of IO size - Wrong IO composition -Occurrence of EEPROM checksum error 	<ul style="list-style-type: none"> -Use expansion slot up to 32. -Compose that IO total size is not excess. -Check composition I/O Module
Input/ Output LED don't operate	<ul style="list-style-type: none"> -Failure of initialize expansion model -Failure of FnBus communication -Do not send any order 	<ul style="list-style-type: none"> -Check connector status both RIO2 series and expansion module. - Check system configuration.

Hitachi Europe GmbH

Am Seestern 18
D-40547 Düsseldorf, Germany

Tel: +49 (0) 211 52 83-0
Fax: +49 (0) 211 52 83-649

HITACHI
Inspire the Next¹