

User Manual – PROFIBUS Adapter

EH-RIO2 Series

RIO2-PBA

Version 1.06



User Manual – PROFIBUS Adapter

DOCUMENT CHANGE SUMMARY				
REV	PAGE	REMARKS	DATE	EDITOR
1.06	All	Created	16.06.2015	Winter

User Manual – PROFIBUS Adapter

CONTENTS

1.	Important Notes.....	1
1.1.	Safety Instruction	2
1.1.1.	Symbols	2
1.1.2.	Safety Notes	2
1.1.3.	Certification	2
2.	Specification.....	3
2.1.	The Interface	3
2.1.1.	RIO2-PBA	3
2.2.	Specification	4
2.2.1.	General Specification	4
2.2.2.	Interface Specification	5
2.3.	LED Indicator	5
2.3.1.	Module Status LED (MOD)	5
2.3.2.	Network Status LED (NET)	6
2.3.3.	Expansion Module Status LED (I/O)	6
2.3.4.	Field Power Status LED	6
3.	Dimension.....	7
3.1.	RIO2-PBA	7
4.	Mechanical Set Up.....	8
4.1.	Total Expansion	8
4.2.	Plugging and Removal of the Components.	8
4.3.	Internal FnBus/Field Power Contacts	9
5.	PROFIBUS Electrical Interface.....	10
5.1.	FnBus System	10
	FnBus Pin Description	11
5.2.	PROFIBUS Electrical Interface	12
5.2.1.	RIO2-PBA	12
5.2.2.	Terminator Resistor	13
5.2.3.	PROFIBUS Address Setup	14
5.2.4.	Choice of PROFIBUS data transfer cable type	15
5.2.5.	I/O Process Image Map	16
5.3.	Example	17
5.3.1.	Example of Output Process Image (Output Register) Map	17
5.3.2.	GSD & I/O Module Setting	18
6.	RIO2-PBA DPV1 Service Specification	19
6.1.	Supported service	19
6.2.	MSAC1 Read (PROFIBUS-DP Extensions to EN50170)	19
6.3.	MSAC1 Write (PROFIBUS-DP Extensions to EN50170)	20
6.4.	Error Decode (PROFIBUS-DP Extensions to EN50170)	21
6.5.	Error Code_1 (PROFIBUS-DP Extensions to EN50170)	22
6.6.	Diagnostics	23

User Manual – PROFIBUS Adapter

7. Trouble Shooting.....	26
7.1. How to diagnose by LED indicator	26
APPENDIX A	28
A.1. Product List	28
A.2. Glossary.....	29

User Manual – PROFIBUS Adapter

1. Important Notes

Solid state equipment has operational characteristics differing from those of electromechanical equipment. Safety Guidelines for the Application, Installation and Maintenance of Solid State Controls describes some important differences between solid state equipment and hard-wired electromechanical devices. Because of this difference, and also because of the wide variety of uses for solid state equipment, all persons responsible for applying this equipment must satisfy themselves that each intended application of this equipment is acceptable.

In no event will Hitachi be responsible or liable for indirect or consequential damages resulting from the use or application of this equipment.

The examples and diagrams in this manual are included solely for illustrative purposes. Because of the many variables and requirements associated with any particular installation, Hitachi cannot assume responsibility or liability for actual use based on the examples and diagrams.

Warning!

- ✓ **If you don't follow the directions, it could cause a personal injury, damage to the equipment or explosion**
- Do not assemble the products and wire with power applied to the system. Else it may cause an electric arc, which can result into unexpected and potentially dangerous action by field devices. Arching is explosion risk in hazardous locations. Be sure that the area is non-hazardous or remove system power appropriately before assembling or wiring the modules.
- Do not touch any terminal blocks or IO modules when system is running. Else it may cause the unit to an electric shock or malfunction.
- Keep away from the strange metallic materials not related to the unit and wiring works should be controlled by the electric expert engineer. Else it may cause the unit to a fire, electric shock or malfunction.



Caution!

- ✓ **If you disobey the instructions, there may be possibility of personal injury, damage to equipment or explosion. Please follow below Instructions.**
- Check the rated voltage and terminal array before wiring. Avoid the circumstances over 55°C of temperature. Avoid placing it directly in the sunlight.
- Avoid the place under circumstances over 85% of humidity.
- Do not place Modules near by the inflammable material. Else it may cause a fire.
- Do not permit any vibration approaching it directly.
- Go through module specification carefully, ensure inputs, output connections are made with the specifications. Use standard cables for wiring.
- Use Product under pollution degree 2 environment.

User Manual – PROFIBUS Adapter

1.1. Safety Instruction

1.1.1. Symbols

<p>DANGER</p> 	<p>Identifies information about practices or circumstances that can cause an explosion in a hazardous environment, which may lead to personal injury or death property damage or economic loss.</p>
<p>IMPORTANT</p>	<p>Identifies information that is critical for successful application and understanding of the product.</p>
<p>ATTENTION</p> 	<p>Identifies information about practices or circumstances that can lead to personal injury, property damage, or economic loss. Attentions help you to identify a hazard, avoid a hazard, and recognize the consequences.</p>

1.1.2. Safety Notes

<p>DANGER</p> 	<p>The modules are equipped with electronic components that may be destroyed by electrostatic discharge. When handling the modules, ensure that the environment (persons, workplace and packing) is well grounded. Avoid touching conductive components, e.g. FnBUS Pin.</p>
--	--

1.1.3. Certification

CE Certificate

EN 61000-6-2; Industrial Immunity

EN 61000-6-4; Industrial Emissions

FCC / LR

RoHS (EU, CHINA)

User Manual – PROFIBUS Adapter

2. Specification

2.1. The Interface

2.1.1. RIO2-PBA

PROFIBUS Connector

Pin No.	Description
3	RxD / TxD-P
4	CNTR-P
5	DGND
6	VP
8	RxD / TxD-N
9	CNTR-N

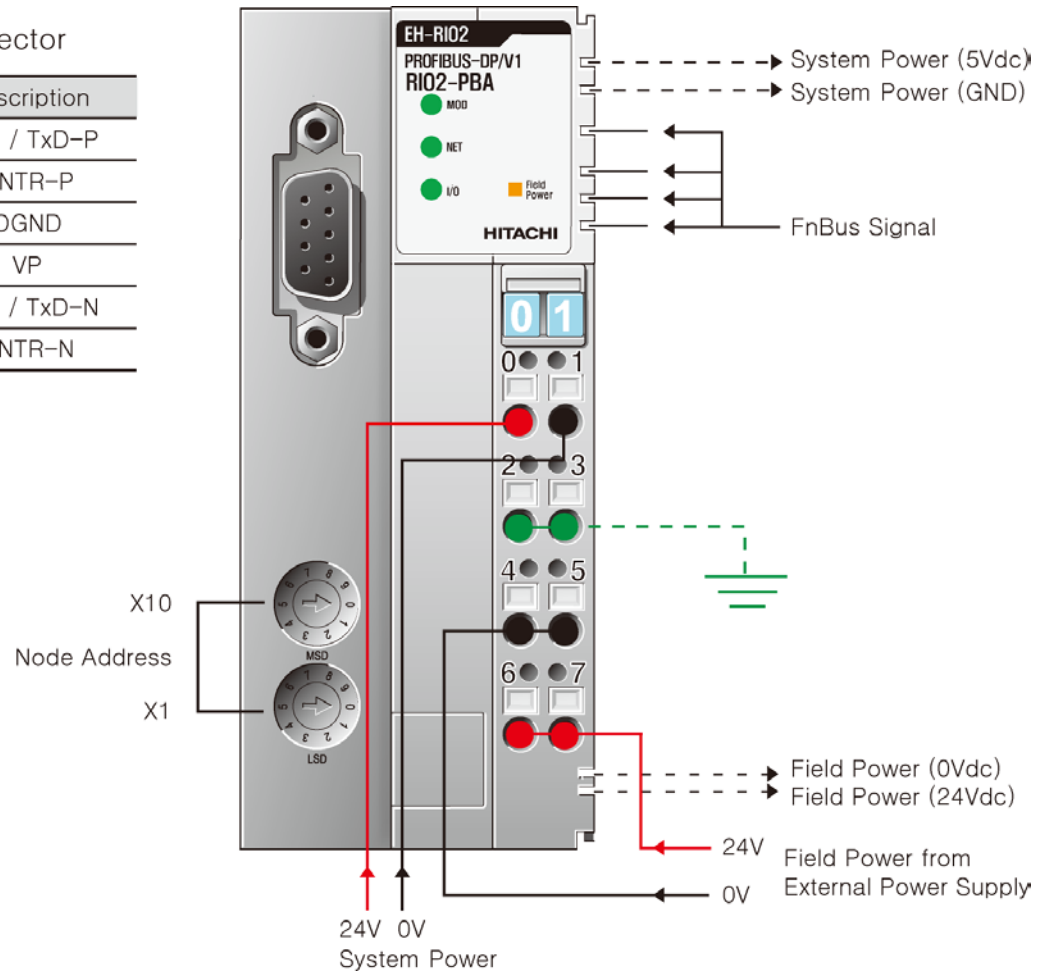

User Manual – PROFIBUS Adapter

2.2. Specification

2.2.1. General Specification

General Specification	
System Power	Supply voltage : 24Vdc nominal Supply voltage range : 11~28.8Vdc Protection : Output current limit (Min. 1.5A) Reverse polarity protection
Power Dissipation	60mA typical @24Vdc
Current for I/O Module	1.5A @5Vdc
Isolation	System power to internal logic : Non-isolation System power to I/O driver : Isolation
Field Power	Supply voltage : 24Vdc nominal Supply voltage range : 11~28.8Vdc
Max. Current Field Power Contact	DC 10A Max.
Weight	155g
Module Size	45mm x 99mm x 70mm
Environment Condition	Refer to Environment Specification

Environmental Specifications	
Operating Temperature	-20 to 55°C
Non-Operating Temperature	-40°C to 85°C
Relative Humidity	5%~90% non-condensing
Operating Altitude	2000m
Mounting	DIN rail

User Manual – PROFIBUS Adapter

2.2.2. Interface Specification

Interface Specification, RIO2-PBA	
Redundancy	Not supported
Repeater Control Signal	TTL
Freeze mode	Support
Sync mode	Support
Auto baudrate	Support
Fail safe mode	Support
Station type	Slave
FMS support	Not supported
Number of Station	100 Station/Max (Rotary switch #0~99)
Number of Expansion I/O slots	Max. 32 slots
I/O Data Size	Total: Input 128bytes / Output 128bytes - Max. Discrete I/O: Input 1024points/Output 1024points - Max. Analog I/O: Input 64channels/Output 64channels
Indicators	1 green/red Module Status Indicator 1 green Network Status Indicator 1 green/red Expansion Module Status indicator 1 green Field Power Status indicator
Baud Rate	9.6K~12M(1.2Km~100m)
Communication Speed	9.6K~12Mbps (Auto baudrate selection)
Module Location	Starter module - left side of FnIO system
Field Power detection	Detect Field Power @11Vdc

2.3. LED Indicator

2.3.1. Module Status LED (MOD)

State	LED is :	To indicate :
No Power	Off	No power is supplied to the unit.
Device Operational	Green	The unit is operating in normal condition.
Device in Standby	Flashing Green	The device needs commissioning due to configuration missing, incomplete or incorrect.
Minor Fault	Flashing Red	Recoverable Fault
Unrecoverable Fault	Red	Rotary switch configuration error

User Manual – PROFIBUS Adapter

2.3.2. Network Status LED (NET)

State	LED is :	To indicate :
Not Powered Not On-line	Off	Device is not on-line or may not be powered
On-line, Not connected	Flashing Green	Device is on-line but has no connections in the established state. - Not allocated to a master
On-line, Connected	Green	Device is on-line and allocated to a master

2.3.3. Expansion Module Status LED (I/O)

State	LED is :	To indicate :
Not Powered No Expansion Module	Off	Device has no expansion module or may not be powered
FnBus On-line, Do not Exchanging I/O	Flashing Green	FnBus is on-line but does not exchanging I/O data - Passed the expansion module configuration.
FnBus Connection, Run Exchanging IO	Green	Expansion Slot is connected and run exchanging I/O data
FnBus connection fault during exchanging IO	Red	One or more expansion module occurred in fault state. - Changed expansion module configuration. - FnBus communication failure.
Expansion Configuration Failed	Flashing Red	Failed to initialize expansion module - Detected invalid expansion module ID. - Overflowed Input / Output Size - Too many expansion module - Initial protocol failure - Mismatch vendor code between adapter and expansion module.

2.3.4. Field Power Status LED

State	LED is :	To indicate :
Not Supplied Field Power	Off	Not supplied 24V dc field power
Supplied Field Power	Green	Supplied 24V dc field power

User Manual – PROFIBUS Adapter

3. Dimension

3.1. RIO2-PBA

(mm)

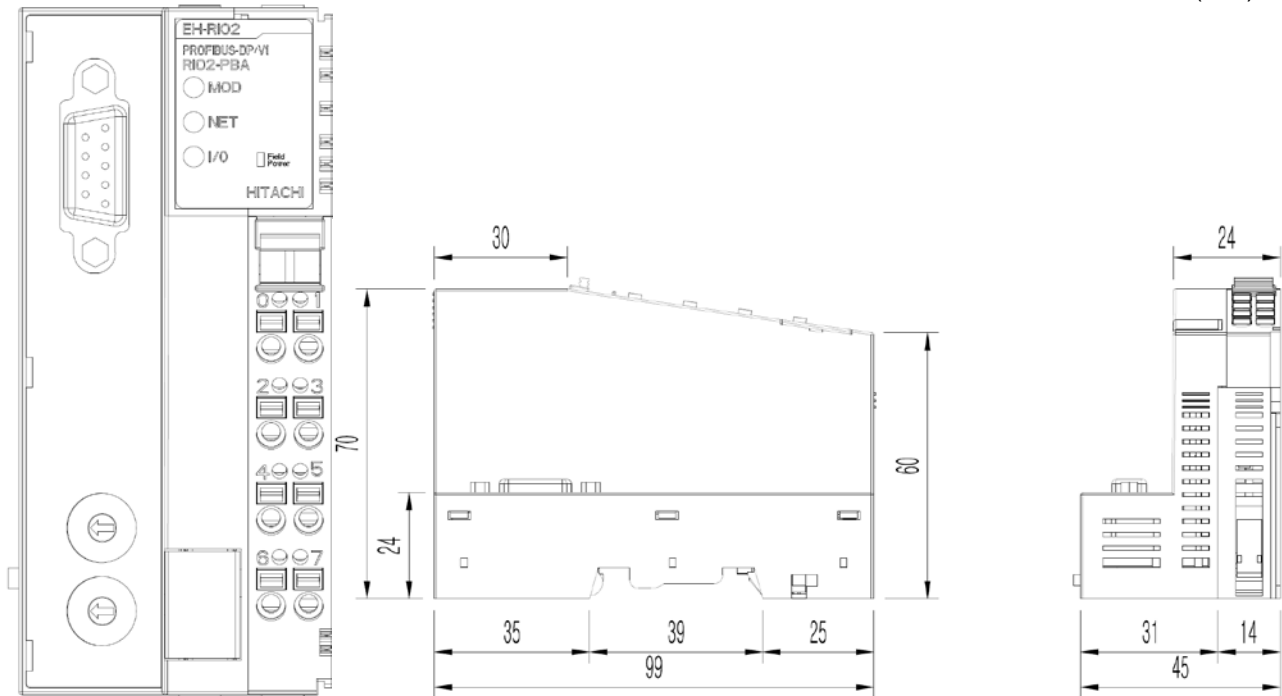

User Manual – PROFIBUS Adapter

4. Mechanical Set Up

4.1. Total Expansion

The number of the module assembly that can be connected is 32. So the maximum length is 426mm
Exception.

RIO2-YR8 is excepted to calculate maximum length because that is double width module.

4.2. Plugging and Removal of the Components.

<p>DANGER</p> 	<p>Before work is done on the components, the voltage supply must be turned off.</p>
--	--



As above figure in order to safeguard the FnIO module from jamming, it should be fixed onto the DIN rail with locking level. To do so, fold on the upper of the locking lever.

To pull out the FnIO module, unfold the locking lever as below figure.

User Manual – PROFIBUS Adapter



4.3. Internal FnBus/Field Power Contacts

Communication between the RIO2 series and the expansion module as well as system / field power supply of the bus modules is carried out via the internal bus. It is comprised of 6 data pin and 2 field power pin.

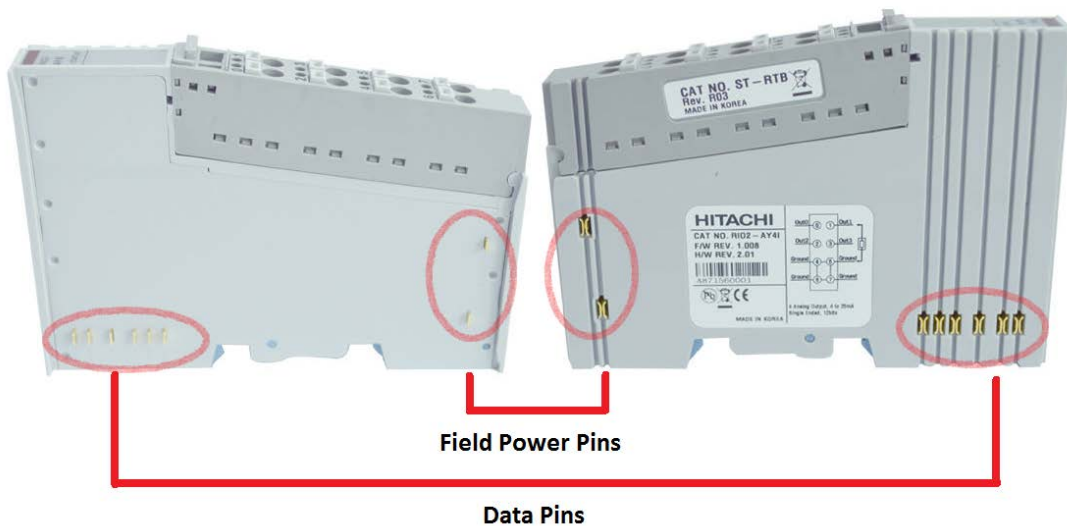

DANGER



Do not touch data and field power pins in order to avoid soiling and damage by noise.

User Manual – PROFIBUS Adapter

5. PROFIBUS Electrical Interface

5.1. FnBus System

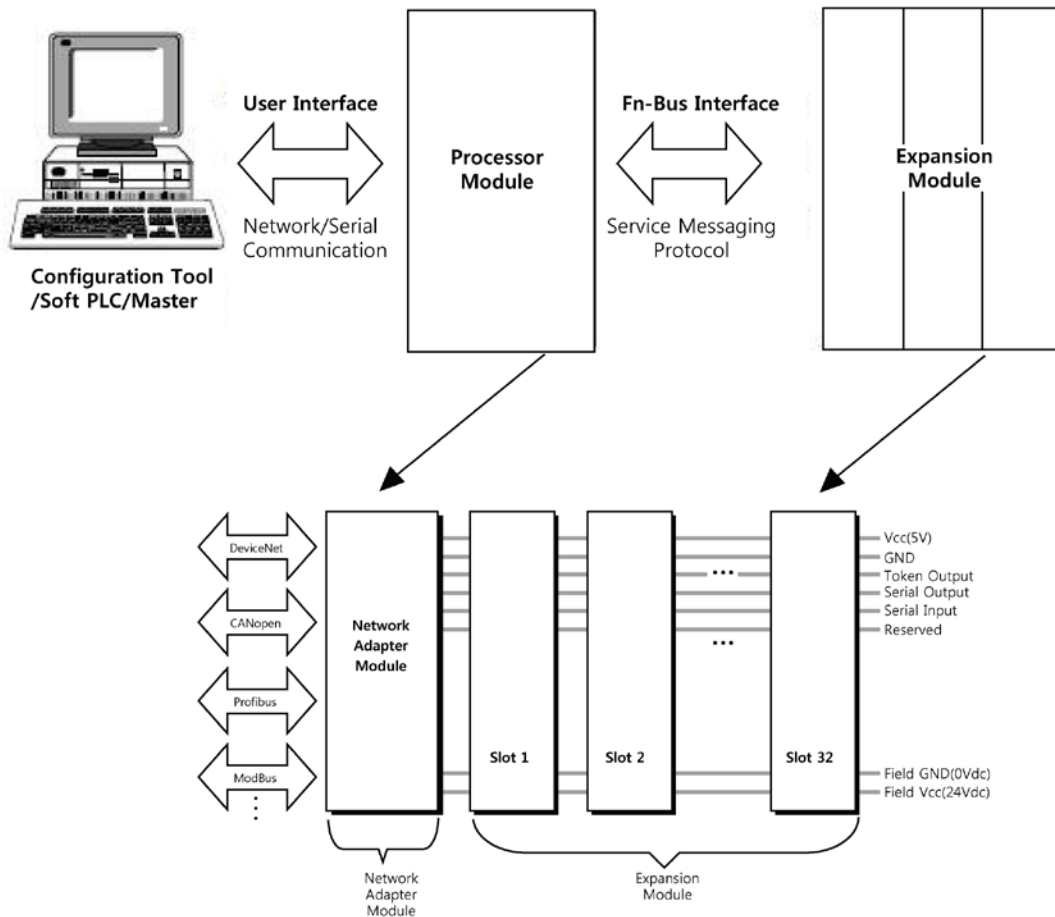

- **Network Adapter Module**

The Network Adapter Module forms the link between the field bus and the field devices with the Expansion Modules.

The connection to different field bus systems can be established by each of the corresponding Network Adapter Module, e.g. for SyncNet, PROFIBUS, CANopen, DeviceNet, Ethernet/IP, CC-Link, MODBUS/Serial, MODBUS/TCP etc.

- **Expansion Module**

The Expansion Modules are supported a variety of input and output field devices. There are digital and analog input/output modules and special function modules.

- **Two types of FnBus Message**

- Service Messaging
- I/O Messaging

User Manual – PROFIBUS Adapter

FnBus Pin Description

No.	Name	Description
1	Vcc	System supply voltage (5V dc).
2	GND	System Ground.
3	Token Output	Token output port of Processor module.
4	Serial Output	Transmitter output port of Processor module.
5	Serial Input	Receiver input port of Processor module.
6	Reserved	Reserved for bypass Token.
7	Field GND	Field Ground.
8	Field Vcc	Field supply voltage (24Vdc).

User Manual – PROFIBUS Adapter

5.2. PROFIBUS Electrical Interface

5.2.1. RIO2-PBA

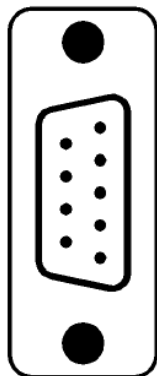

Dsub 9 (Female)	Signal Name	Description
1	-	
2		
3	RXD/TXD-P	Receive/Transmit data-plus(B wire)
4	CNTR-P	Repeater control signal(direction control), RTS signal
5	DGND	Data ground(reference potential for VP)
6	VP	Supply voltage-Plus(P5V)
7	-	
8	RXD/TXD-N	Receive/Transmit data-minus(A-wire)
9	-	

All Fieldbus devices which use a standard 9-pin Sub-D connector should provide the VP and DGND signals on the bus connector in addition to the receive and transmit signals. With all other connector types, only the receive and transmit signals need to be connected.

Make sure that the connector type used is suitable for the selected baud rate.

If optional signal are provided, they must also comply with EN50170 Volume 2 and they must be correctly described in the respective GSD file.

To prevent EMC interface from entering the device, the cable shield should be connected to the functional ground of the device (generally the electrically conductive case). This is done by connecting the cable shield to the metal case of the Sub-D connector and the functional ground over a larger area. The bus connector must have a low-impedance connection to the cable shield.

The data transfer technology of the serial bus system, which uses a shielded twisted pair data cable, is described in the specification of the interface-immune RS 485 interface standard. To allow correct bus termination, each station must connect the signals DGND and VP (5V) to pins 5 and 6 of the connector, respectively. The 5V supply for the terminating resistors (VP) should have a minimum current rating of 10mA (the current load can increase to 12mA if a NULL signal is sent through the bus). The current rating should be increased to app.

90mA if you need to be able to supply other types of devices on the bus such as bus terminals and optical fiber cable drivers. Due to the capacitive load of the station and the resulting cable reflections, bus connectors should be provided with built-in series inductors as shown below.

ATTENTION



The use of an incorrect supply voltage or frequency can cause severe damage to the component.

User Manual – PROFIBUS Adapter

5.2.2. Terminator Resistor

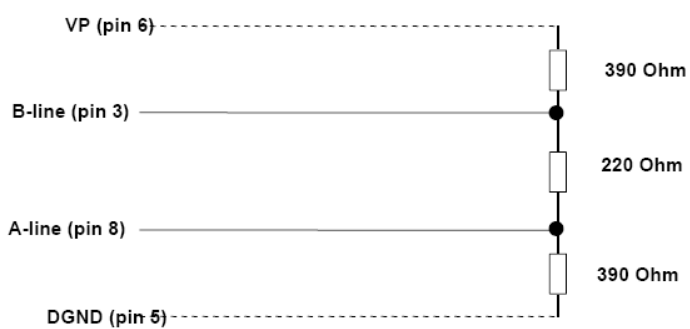
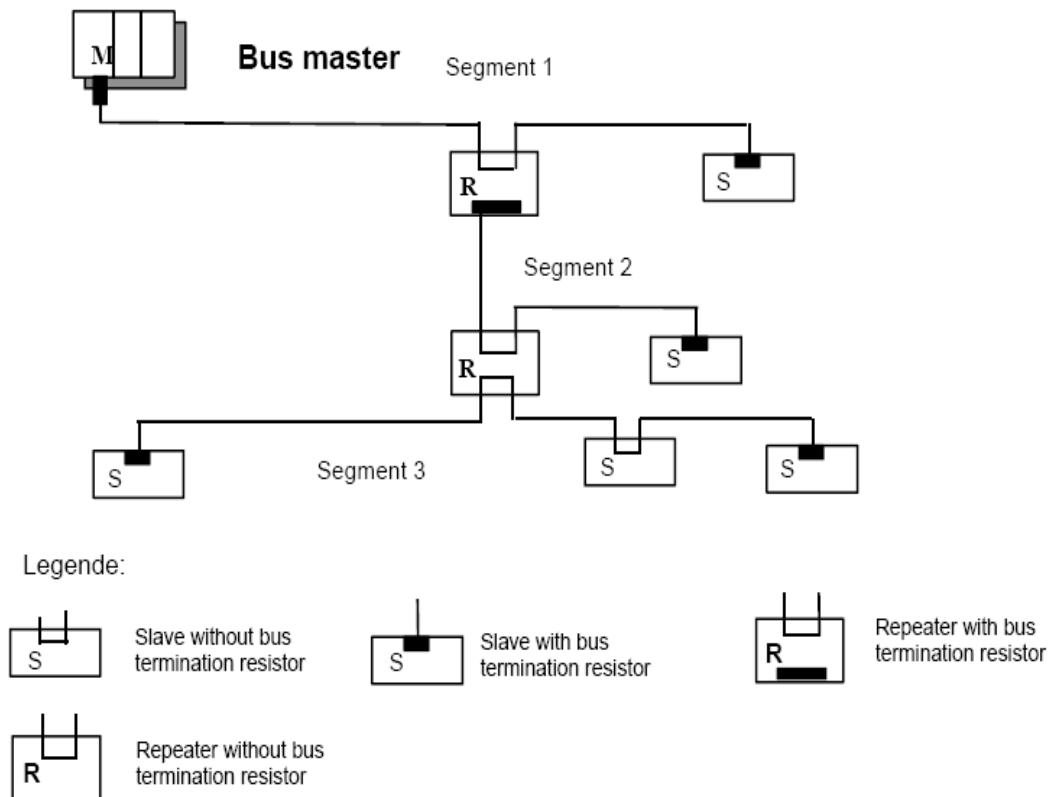

In order to minimize cable reflections and ensure a defined noise level on the data lines, the data transfer cable must be terminated at both ends with a terminating resistor combination as follows.

User Manual – PROFIBUS Adapter

5.2.3. PROFIBUS Address Setup

Each PROFIBUS Adapter could have a unique address (from 1 to 99) so that it can be addressed independently from other nodes. The address 0 is reserved to identify a broadcast exchange. No response is returned to broadcast requests sent by the master.

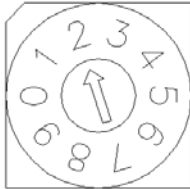

X 10 (MSD)

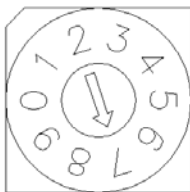

X 1 (LSD)

The above figure shows MAC ID 27(=2*10 + 7*1) of a slave node.

◆ Communication Speed Setting

- See Master Module Setting about communication speed setting.

ATTENTION



MAC ID addresses have to be unique throughout the entire interconnected networks.

User Manual – PROFIBUS Adapter

5.2.4. Choice of PROFIBUS data transfer cable type

- Depending on the application, the user can choose between electrical and optical fiber data transfer cables. The following types of electrical data cables can be used:
 - **Standard bus cable**
 - **Standard bus cable with halogen-free sheath (type FRNC)**
 - **Cable with PE Sheath** for use in the food and manufacturing industries. (It differs from the standard bus cable solely in the cable sheath).
 - **Direct buried cable** with additional protective sheath for laying in the ground.
 - **Trailing cable** (this is a special cable type which is used where parts of the machine move occasionally or continuously).
 - **Festooned cable**. Compared to a trailing cable, a festooned cable has an additional strain relief element.
- The bus cable is specified in EN 50170 part 8-2 as " Cable Type A", and should comply with the parameters in the following table. Cable Type B, which is also described in EN 50170, is outdated and should no longer be used.

- **Table 1. show the parameters for standard type A bus cables.**

Parameter	Cable type A
Characteristic impedance in Ω	135..165 at a frequency of (3..20MHz)
Operating capacity(pF/m)	< 30
Loop resistance (Ω /km)	<=110
Core diameter (mm)	>0.64*
Cora cross-section (mm)	>0.34*

* The cable cross-sections used should be compatible with the mechanical specifications of the bus interface connector

The cable parameters specified for standard Type A bus cables result in the maximum length of each bus segment for the respective data transfer rate shown in Table 2.

- **Table 2 : Maximum cable lengths per segment**

Baudrate	9.6	19.2	45.45	93.75	187.5	500	1500	3000	6000	12000
Max. segment Length in 'm'(m)	1200	1200	1200	1200	1000	400	200	100	100	100

- **Important** : In a PROFIBUS-DP/FMS installation, you must choose a data transfer rate which is supported by all devices connected to the bus. The chosen data transfer rate then determines the maximum segment lengths as shown above.

The maximum admissible distance between two bus stations in each PROFIBUS network can be calculated as follows:

- **(NO_REP+1)*Segment length**
NO_REP=The maximum number of repeaters connected in series(depends on repeater type).
- **Example** : The repeater manufacture specifications allow nine repeaters to be connected in series. The maximum distance between two bus stations at a data transfer rate of 1500 Kbit/s is then as follow:
 $(9+1)*200m=2000m$

User Manual – PROFIBUS Adapter

5.2.5. I/O Process Image Map

An expansion module may have 3 types of data as I/O data, configuration parameter and memory register.

The data exchange between network adapter and expansion modules is done via an I/O process image data by FnBus protocol. The following figure shows the data flow of process image between network adapter and expansion modules.

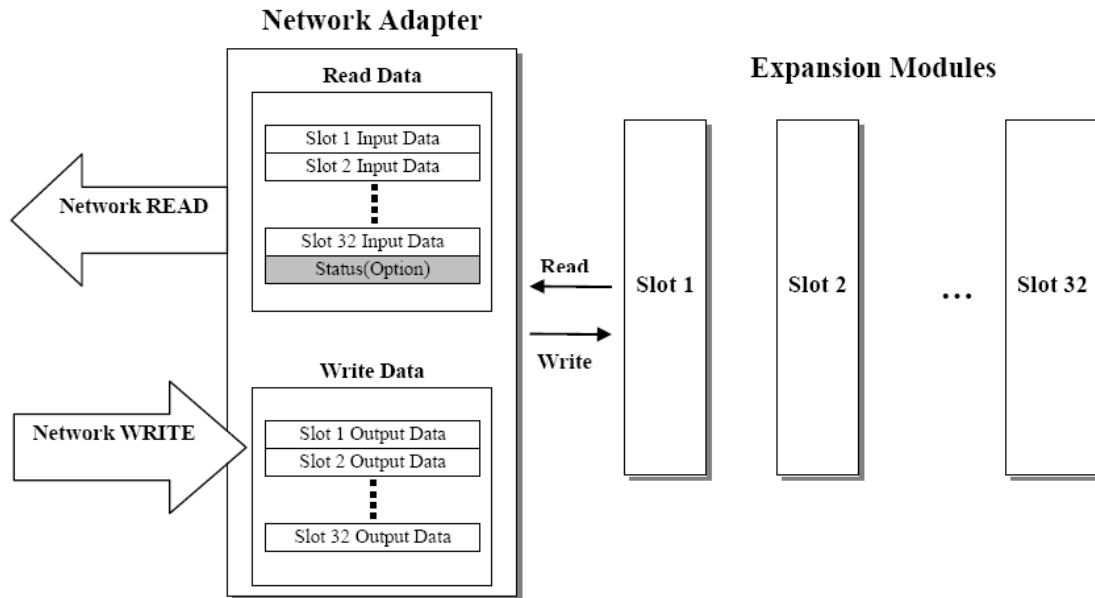

User Manual – PROFIBUS Adapter

5.3. Example

5.3.1. Example of Output Process Image (Output Register) Map

- For example slot configuration



Slot Address	Module Description
#0	PROFIBUS Adapter
#1	4-discrete output
#2	8-discrete output
#3	2-analog output
#4	16-discrete output
#5	4-discrete output
#6	8-discrete output
#7	2-relay output
#8	2-relay output
#9	2-analog output
#10	16-discrete output
#11	4-discrete output

- Output Process Image Mode#0

(Uncompressed Output Processing Data)

Byte	Slot #	Bit 7	Bit 6	Bit 5	Bit 4	Bit 3	Bit 2	Bit 1	Bit 0	
Write Byte 0	Slot 1	Not used				Discrete Output 4 points				
Write Byte 1	Slot 2	Discrete Output 8 points								
Write Byte 2	Slot 3	Analog Output Ch0 low byte								
Write Byte 3		Analog Output Ch0 high byte								
Write Byte 4		Analog Output Ch1 low byte								
Write Byte 5		Analog Output Ch1 high byte								
Write Byte 6	Slot 4	Discrete Output low 8 points								
Write Byte 7		Discrete Output high 8 points								
Write Byte 8	Slot 5	Not used				Discrete Output 4 points				
Write Byte 9	Slot 6	Discrete Output 8 points								
Write Byte 10	Slot 7	Not used							Discrete Out 2 pts	
Write Byte 11	Slot 8	Not used				Discrete Out 4 pts		Discrete Out 2 pts		
Write Byte 12	Slot 9	Analog Output Ch0 low byte								
Write Byte 13		Analog Output Ch0 high byte								
Write Byte 14		Analog Output Ch1 low byte								
Write Byte 15		Analog Output Ch1 high byte								
Write Byte 16	Slot 10	Discrete Output low 8 points								
Write Byte 17		Discrete Output high 8 points								
Write Byte 18	Slot 11	Reserved				Discrete Output 4 points				

User Manual – PROFIBUS Adapter

5.3.2. GSD & I/O Module Setting

GSD (Electronic data sheet of a device) files contain and describe the functions and characteristics of PROFIBUS devices. The abbreviation GSD means Generic Station Description (Device Base Files). All the available GSD files together form the device database.

When the program is started, the System Configurator automatically retrieves all the GSD files stored in the GSD directory.

The device names are placed into an internal into a list. During the configuration, the device-specific data is retrieved directly from the GSD files.

If a DP Slave device does not appear in the selection list, a corresponding GSD file can be copied into the GSD directory **File > Copy GSD**.

Another possibility is to copy the GSD file into GSD directory with the Windows Explore and then retrieve the GSD files into the GSD directory with **Setting > Path** and **OK**.

The GSD files can be viewed with the **Tools > GSD Viewer** menu.



- Hilscher Devices: The GSD files for Hilscher devices are already included and installed.
- Other Devices: The respective device manufacturer provides the GSD files for other devices. The GSD files of many vendors are available on the PROFIBUS user organization home page.

The GSD directory is adjustable. In order to alter the directory from a previous setting in another directory, use the **Setting > Path** menu.

All GSD files must be placed in this directory.

No GSD files are used for PROFIBUS-FMS. Hilscher PROFIBUS-FMS devices as well as Other FMS Devices for all vendors are available in the selection list of the Master.

The GSD Files for PROFIBUS-FMS specified by the PNO (PROFIBUS User Organization) are not supported by the System Configurator.

User Manual – PROFIBUS Adapter

6. RIO2-PBA DPV1 Service Specification

6.1. Supported service

- ✓ MSAC1 Read
- ✓ MSAC1 Write
- ✓ MSAC2 Initiate / MSAC2 Abort
- ✓ MSAC2 Read
- ✓ MSAC2 Write

6.2. MSAC1 Read (PROFIBUS-DP Extensions to EN50170)

● MSAC1 Read Request

Parameter	Description
Remote Address	Slave Address (0~99)
Slot Number	Slot Number (0~32), 0 : RIO2-PBA 1~32 : IO
Index	1 : Parameter 2 : Memory 253 : FW revision (Data size : 4 bytes) 254 : Vendor Code (Data size : 1 byte)
Length	1~128

● RIO2-PBA Parameter (Hilscher Master Card from Command Message)

Byte address	Description		Value
[0]	NA Status 1	DPV1 activation	0x80(DPV1 activated)
[3]	Word data format	Intel	0x00
		Motorola	0x01
[4]	DP Clear action	FnBus Stop(IO's fault action)	0x00
		FnBus Run(Clear output)	0x04
		FnBus run(Hold output)	0x08
	Reaction to FnBus fault	Profibus communication stops	0x00
		Clear input data	0x01
		Stay with the last input value	0x02
	Restart on FnBus fault	Power reset	0x00
		Auto reset	0x10

User Manual – PROFIBUS Adapter

- **Command message for Function Read** (Hilscher Master Card from Command Message)

Command Message			
Variable	Type	Value	Signification
Message Header			
RX	Byte	3	Receiver
TX	Byte	16	Transmitter
LN	Auto		Length of message
NR	Byte	0	Number of the message
A	Byte	0	No answer
F	Byte	0	Error, state
B	Byte	0x11	Command = MSAC1_Read_Write
E	Byte	0	Extension
Extended Message Header			
Device Adr.	Byte	0 ~ 99	Remote address(slave station)
Data Area	Byte	0	Data area, unused
Data Adr.	Word	0 ~ 254	Slot number
Data Idx.	Byte	1, 2, 253, 254	Index
Data count	Byte	0 ~ 128	Length of data block to be read
Data type	Byte	0 or 10	Data type, byte string
Function	Byte	1	Function MSAC1_Read

6.3. MSAC1 Write (PROFIBUS-DP Extensions to EN50170)

- **MSAC1 Write Request**

Parameter	Description
Remote Address	Slave Address (0~99)
Slot Number	Slot Number(0~32), 0 : NA9122 1~32 : IO
Index	1 : Parameter 2 : Memory
Length	1~128
Data	1. Parameter 2. Memory *Refer to "FnIO configuration parameter" document.

User Manual – PROFIBUS Adapter

- **Command message for Function Write** (Hilscher Master Card from Command Message)

Command Message			
Variable	Type	Value	Signification
Message Header			
RX	Byte	3	Receiver
TX	Byte	16	Transmitter
LN	Auto		Length of message
NR	Byte	0	Number of the message
A	Byte	0	No answer
F	Byte	0	Error, state
B	Byte	0x11	Command = MSAC1_Read_Write
E	Byte	0	Extension
Extended Message Header			
Device Adr.	Byte	0 ~ 99	Remote address(slave station)
Data Area	Byte	0	Data area, unused
Data Adr.	Word	0 ~ 254	Slot number
Data Idx.	Byte	1, 2	Index
Data count	Byte	0 ~ 128	Length of data block to be read
Data type	Byte	0 or 10	Data type, byte string
Function	Byte	2	Function MSAC1_Write

6.4. Error_Decode (PROFIBUS-DP Extensions to EN50170)

- 0~127 : Reserved
- 128 : DPV1
- 129~253 : Reserved
- 254 : FMS
- 255 : HART

User Manual – PROFIBUS Adapter

6.5. Error Code_1 (PROFIBUS-DP Extensions to EN50170)

Bit	7	6	5	4	3	2	1	0
	<ul style="list-style-type: none"> ● Error Class <ul style="list-style-type: none"> ✓ 0xA : Application class 				<ul style="list-style-type: none"> ● Error code <ul style="list-style-type: none"> ✓ 0 : Read Error ✓ 1 : Write Error ✓ 2 : Module Failure ✓ 3 ~7 : Reserved ✓ 8 : Version conflict ✓ 9 : Feature not supported ✓ 10~15 : User specific 			
	<ul style="list-style-type: none"> ● Error Class <ul style="list-style-type: none"> ✓ 0xB : Access class 				<ul style="list-style-type: none"> ● Error code <ul style="list-style-type: none"> ✓ 0 : Invalid index ✓ 1 : Write length error ✓ 2 : Invalid slot ✓ 3 : Type conflict ✓ 4 : Invalid area ✓ 5 : state conflict ✓ 6 : access denied ✓ 7 : invalid range ✓ 8 : invalid parameter ✓ 9 : invalid type ✓ 10~15 : User specific 			
	<ul style="list-style-type: none"> ● Error Class <ul style="list-style-type: none"> ✓ 0xC : Resource class 				<ul style="list-style-type: none"> ● Error code <ul style="list-style-type: none"> ✓ 0 : read constrain conflict ✓ 1 : Write constrain conflict ✓ 2 : Resource busy ✓ 3 : Resource unavailable ✓ 4 ~7 : Reserved ✓ 8~15 : User specific 			
	<ul style="list-style-type: none"> ● Error Class <ul style="list-style-type: none"> ✓ 0xD : RIO2-PBA Specific Class 				<ul style="list-style-type: none"> ● Error code <ul style="list-style-type: none"> ✓ 1 : Slot Parameter write error ✓ 2 : Read memory error ✓ 3 : Write memory error 			

User Manual – PROFIBUS Adapter

6.6. Diagnostics

Command Message			
Variable	Type	Value	Signification
Message Header			
RX	Byte	3	Receiver
TX	Byte	16	Transmitter
LN	Auto	8	Length of message
NR	Byte	0	Number of the message
A	Byte	0	No answer
F	Byte	0	Error, state
B	Byte	66(0x42)	Command = MSAC1_Read_Write
E	Byte	0	Extension
Extended Message Header			
Device Adr.	Byte	0 ~ 99	Remote address(slave station)
Data Area	Byte	0	Data area, unused
Data Adr.	Word	0	Data address, unused
Data Idx.	Byte	0	Index
Data count	Byte	0	Length of data block to be read
Data type	Byte	0 or 10	Data type, byte string
Function	Byte	1, 3	1. Function read from internal Buffer 3. Function read directly from slave

Byte	Item	Description
0	Station status 1	PROFIBUS Standard Diagnostic
1	Station status 2	
2	Station status 3	
3	Master Address	
4	PNO Ident Number High	
5	PNO Ident Number Low	
6	ID Diagnostic Header	Extended Diagnostic (ID Related Diagnostic)
7	Diagnostic allocation(Slot0~7)	
8	Diagnostic allocation(Slot8~15)	
9	Diagnostic allocation(Slot16~23)	
10	Diagnostic allocation(Slot24~31)	
11	Diagnostic allocation(Slot32~39)	
12	Reserved	Extended Diagnostic (Device Status)
13		
14		
15		
16	Status Type(0xA0:Manufacture-specific)	
17	Slot Number	
18	Status differentiation(0:No differentiation)	
19	Status message	
20	Reserved	

User Manual – PROFIBUS Adapter

- Station Status 1~3

Station status			
1	Bit 7	Master_Lock	Slave is parameterized by another master
	Bit 6	Prm_Fault	Last parameter telegram faulty
	Bit 5	Inv._SI_Res.	Implausible response of the slave
	Bit 4	Not_Supp.	Unknown command detected by the slave
	Bit 3	Ext_Diag	The area Ext_Diag is used for extended diagnostic
	Bit 2	Cfg_Fault	Slave is wrong parameterized
	Bit 1	Sta._Not_Rdy	Slave not ready
	Bit 0	Sta._Non_Exist.	Slave not responding
2	Bit 7	Deactivated	Slave not projected
	Bit 6	Reserved	Reserved
	Bit 5	Sync_Mode	Sync-command active
	Bit 4	Freeze_Mode	Freeze-command active
	Bit 3	WD_On	Watchdog activated
	Bit 2	1	
	Bit 1	Stat_Diag	Get diagnostic from slave, till bit is released
	Bit 0	Prm_	Slave must be parameterized
3	Bit 7	Ext_Diag_Ovfl.	The slave has more diagnostic data available than it can send

- ID Related Diagnostic

Byte	Bit7	Bit 6	Bit 5	Bit 4	Bit 3	Bit 2	Bit 1	Bit 0
6	ID Diagnostic Header (0x45)							
7	Slot 7	Slot 6	Slot 5	Slot 4	Slot 3	Slot 2	Slot 1	RIO2-PBA
8	Slot 15	Slot 14	Slot 13	Slot 12	Slot 11	Slot 10	Slot 9	Slot 8
9	Slot 23	Slot 22	Slot 21	Slot 20	Slot 19	Slot 18	Slot 17	Slot 16
10	Slot 31	Slot 30	Slot 29	Slot 28	Slot 27	Slot 26	Slot 25	Slot 24
11	Reserved							Slot 32

User Manual – PROFIBUS Adapter

● Device Related Diagnostic(Status message byte)

- 0x21 : No response from expansion slot
- 0x22 : Response error(Type)
- 0x23 : Response error(Slot Number)
- 0x24 : Response error(Length)
- 0x25 : Response error(Protocol)
- 0x26 : Response error(ID)
- 0x27 : Response error(Function code)
- 0x28 : Response error(CRC)
- 0x29 : Response error(Data)
- 0x2A : Response error(Sequence)
- 0x2B : NA9122 Request error
- 0x2C : NA9122 Broadcasting error
- 0x41 : FnBus Rx Timeout
- 0x42 : Faulty input data(Type)
- 0x43 : Faulty input data(Slot number)
- 0x44 : Faulty input data(Length)
- 0x45 : Faulty input data(CRC)
- 0x46: Faulty input data (Slot diag.)
- 0x47 : Input update timeout
- 0x48 : FnBus token fault
- 0xC1 : Resource error of slot
- 0xC2 : Not supported service from slot
- 0xC3 : Attribute error from slot
- 0xC4 : Slot is already in this mode
- 0xC5 : Object conflict from slot
- 0xC6 : Attribute not settable
- 0xC7 : Insufficient data
- 0xC8 : Not supported attribute
- 0xC9 : Too much data
- 0xCA : Object not exist
- 0xCB : Invalid slot parameter
- 0xCC : Store fail
- 0xCD : Access denied
- 0xCE : FnBus token error
- 0xCF : Object not exist
- 0xD0 : Slot memory size over
- 0xE1 : No expansion slot
- 0xE2 : Too many slots
- 0xE3 : Input data size overflow
- 0xE4 : Output data size overflow
- 0xE5 : Invalid product code
- 0xE6 : Set output-offset error
- 0xE7 : Set slot active-flag error
- 0xE8 : Set slot parameter error
- 0xE9 : Set FnBus parameter error
- 0xEA : Slot warm-start error
- 0xEB : Get slot catalog number error
- 0xEC : Invalid slot request
- 0xED : Firmware fault
- 0xEE : Set word-type error
- 0xF0 : Vendor code fault
- 0xFF : Not ready

User Manual – PROFIBUS Adapter

7. Trouble Shooting

7.1. How to diagnose by LED indicator

LED Status	Cause	Action
All LED turns off	- No power	- Check main power Cable
	- System power is not supplied.	- Contact Sales team and send module for repair.
MOD LED is red	- Wrong address ID - Occurrence critical error in firmware	- Contact Sales team and send module for repair.
I/O LED turns off	- Failure of realization expansion Module - None expansion Module	- Check connector status both RIO2 series and expansion module.
I/O LED flashes red	Failure of configuration baud rate	- Check communication cable with Master - Check power for master.
	Failure of initialization I/O	- Use expansion slot up to 32. - Compose that IO total size is not excess. RIO2 series notice unidentified expansion module ID. Check status of expansion module.
I/O LED is red	Failure of exchanging I/O data	Check status of expansion IO connection.
NET LED turns off	Failure of communication with Master	Check main power for master and communication cable.
NET LED flashed green	Failure of exchanging data with master	Check status in software for Master configuration.

User Manual – PROFIBUS Adapter

7.2. How to diagnose when device couldn't communicate network

Inspection of wrong or omission cable connection.

- Check status of cable connection for each node.
- Check that all color matches between connector and cable.
- Check wire omission.

Terminator resistor

- If terminator resistor is not installed, install terminator resistor
- Check location of terminator resistor

Configuration of Node address

- Check duplication node address.

Configuration of Master

- Check configuration of master
- Check whether to do download or don't
- Check composition is right
- Configuration of communication baud rate
- I/O size
- Configuration of each node

Ground and environment

- Check ground is contacted
- Check environment factor (temperature, humidity, etc) is in less than regular limit

User Manual – PROFIBUS Adapter

APPENDIX A

A.1. Product List

No.	Number	Description	Production Status
Digital Input Module			
	RIO2-XDP4	4 Points, Sink(Positive), 12V/24Vdc,	Active
	RIO2-XDP8	8 Points, Sink(Positive), 12V/24Vdc,	Active
	RIO2-XDP16	16 Points, Sink(Positive), 12V/24Vdc,	Active
	RIO2-XAH4	4 Points, 220Vac,	Active
Digital Output Module			
	RIO2-YTP16	16 Points Source(Positive Logic), 24Vdc/0.5A,	Active
	RIO2-YTP4	4 Points Source(Positive Logic), 24Vdc/0.5A,	Active
	RIO2-YTP8	8 Points Source(Positive Logic), 24Vdc/0.5A,	Active
	RIO2-YTP4C	4 Points Source(Positive Logic), 24Vdc/2A,	Active
	RIO2-YR4	4 Points, 230Vac/2A, 24Vdc/2A, Relay	Active
	RIO2-YR8	8 Points, 230Vac/2A, 24Vdc/2A, Relay	Active
Analog Input Module			
	RIO2-AX4I	4 Channels, Current, 4~20mA, 12bit	Active
	RIO2-AX8I	8 Channels, Current, 4~20mA, 12bit	Active
	RIO2-AX4V	4 Channels, Voltage, 0~10Vdc, 12bit	Active
	RIO2-AX8V	8 Channels, Voltage, 0~10Vdc, 12bit	Active
	RIO2-AX4H	4 Channels, Voltage, -10Vdc~10Vdc, 12bit	Active
	RIO2-RTD2	2 Channels, RTD, Status	Active
	RIO2-RTD4	4 Channels, RTD, Status	Active
	RIO2-RTD8	8 Channels, RTD, Status	Active
	RIO2-TC2	2 Channels, TC	Active
	RIO2-TC4	4 Channels, TC	Active
Analog Output Module			
	RIO2-AY2I	2 Channels, Current, 4~20mA, 12bit	Active
	RIO2-AY4I	4 Channels, Current, 4~20mA, 12bit	Active
	RIO2-AY2V	2 Channels, Voltage, 0~10Vdc, 12bit	Active
	RIO2-AY4V	4 Channels, Voltage, 0~10Vdc, 12bit	Active
	RIO2-AY2H	2 Channels, Voltage, -10~10Vdc, 12bit	Active
Special Module			
	RIO2-CU24	1 Channel, High Speed Counter, 24V Input	Active
	RIO2-CU24L	2 Channel, High Speed Counter, 24V Sink Input	Active
	RIO2-RS232	RS232 Communication, 1Channel, RTS/CTS Flow Control	Active
	RIO2-RS485	RS485 Communication, 1Channel	Active
	RIO2-PWM2	2 CH PWM output, 0.5A/24Vdc, source	Active

User Manual – PROFIBUS Adapter

A.2. Glossary

- System Power: The power for starting up CPU.
- Field Power: The power for input and output line.
- Terminator Resistor: Resistor for prevention reflected wave.
- EDS: Electronic Data Sheet.
- sinking: The method of input and output what device does not have power source.
- sourcing: The method of input and output what device have power source.

Hitachi Europe GmbH

Am Seestern 18
D-40547 Düsseldorf, Germany

Tel: +49 (0) 211 52 83-0
Fax: +49 (0) 211 52 83-649

HITACHI
Inspire the Next[!]