

# **HITACHI Web Controller**

---

## **USERS MANUAL**

---

NJI-441E

---

## WARNING

To ensure that the equipment described by this manual, as well as all equipment connected to and used with it, operate satisfactorily and safely, all applicable local and national codes that apply to installing and operating the equipment must be followed. Since codes can vary geographically and can change with time, it is the user's responsibility to determine which standard and codes apply, and to comply with them.

FAILURE TO COMPLY WITH APPLICABLE CODES AND STANDARDS CAN RESULT IN DAMAGE TO EQUIPMENT AND / OR SERIOUS INJURY TO PERSONNEL.  
INSTALL EMERGENCY POWER STOP SWITCH WHICH OPERATES INDEPENDENTLY OF THE PROGRAMMABLE CONTROLLER TO PROTECT THE EQUIPMENT AND / OR PERSONNEL IN CASE OF THE CONTROLLER MALFUNCTION.

Personnel who are to install and operate the equipment should carefully study this manual and any others referred to by it prior to installation and / or operation of the equipment. Hitachi, Ltd. constantly strives to improve its products, and the equipment and the manual(s) that describe it may be different from those already in your possession.

If you have any questions regarding the installation and operation of the equipment, or if more information is desired, contact your local Authorized Distributor or Hitachi, Ltd.

## IMPORTANT

THIS EQUIPMENT GENERATES, USES, AND CAN RADIATE RADIO FREQUENCY ENERGY AND, IF NOT INSTALLED AND USED IN ACCORDANCE WITH THE INSTRUCTION MANUAL, MAY CAUSE INTERFERENCE TO RADIO COMMUNICATIONS. AS TEMPORARILY PERMITTED BY REGULATION, IT HAS NOT BEEN TESTED FOR COMPLIANCE WITH THE LIMITS FOR CLASS A COMPUTING DEVICES PURSUANT TO SUBPART J OF PART 15 OF FCC RULES, WHICH ARE DESIGNED TO PROVIDE REASONABLE PROTECTION AGAINST SUCH INTERFERENCE.

OPERATION OF THIS EQUIPMENT IN A RESIDENTIAL AREA IS LIKELY TO CAUSE INTERFERENCE IN WHICH CASE THE USER, AT HIS OWN EXPENSE, WILL BE REQUIRED TO TAKE WHATEVER MEASURES MAY BE REQUIRED TO CORRECT THE INTERFERENCE.

---

## LIMITED WARRANTY AND IMITATION OF LIABILITY

Hitachi, Ltd. (Hitachi) warrants to the original purchaser that the programmable controller (PLC) manufactured by Hitachi is free from defects in material and workmanship under normal use and service. The obligation of Hitachi under this warranty shall be limited to the repair or exchange of any part or parts which may prove defective under normal use and service within eighteen (18) months from the date of manufacture or twelve (12) months from the date of installation by the original purchaser whichever occurs first, such defect to be disclosed to the satisfaction of Hitachi after examination by Hitachi of the allegedly defective part or parts. This warranty is expressly in lieu of all other warranties expressed or implied including the warranties of merchantability and fitness for use and of all other obligations or liabilities and Hitachi neither assumes, nor authorizes any other person to assume for Hitachi, any other liability in connection with the sale of this PLC. This warranty shall not apply to this PLC or any part hereof which has been subject to accident, negligence, alteration, abuse, or misuse. Hitachi makes no warranty whatsoever in respect to accessories or parts not supplied by Hitachi. The term "original purchaser", as used in this warranty, shall be deemed to mean that person for whom the PLC is originally installed.

In no event, whether as a result of breach of contract, warranty, tort (including negligence) or otherwise, shall Hitachi or its suppliers be liable for any special, consequential, incidental or penal damages including, but not limited to, loss of profit or revenues, loss of use of the products or any associated equipment, damage to associated equipment, cost of capital, cost of substitute products, facilities, services or replacement power, down time costs, or claims of original purchaser's customers for such damages.

To obtain warranty service, return the product to your distributor, or send it with a description of the problem, proof of purchase, post paid, insured, and in a suitable package to:

Quality Assurance Dep.

Hitachi Industrial Equipment Systems Co., Ltd.

46-1, Ooaza-Tomioka Nakajo-machi

Kitakanbara-gun, Niigata-ken

959-2608 JAPAN

---

Copyright 2000 by Hitachi Industrial Equipment Systems Co., Ltd.  
All Rights reserved - Printed in Japan

The information and/or drawings set forth in this document and all rights in and to inventions disclosed herein and patents which might be granted thereon disclosing or employing and the materials, techniques or apparatus described herein are the exclusive property of Hitachi, Ltd.

No copies of the information or drawings shall be made without the prior consent of Hitachi, Ltd.

Hitachi, Ltd. provides customer assistance in varied technical areas. Since Hitachi does not possess full access to data concerning all of the uses and applications of customer's products, responsibility is assumed by Hitachi neither for customer product design nor for any infringements of patents or rights of others which may result from Hitachi assistance.

The specifications and descriptions contained in this manual were accurate at the time they were approved for printing. Since Hitachi, Ltd. Incorporated constantly strives to improve all its products, we reserve the right to make changes to equipment and/or manuals at any time without notice and without incurring any obligation other than as noted in this manual.

Hitachi, Ltd. assumes no responsibility for errors that may appear in this manual.

As the product works with user program and Hitachi, Ltd. cannot test all combination of user program components, it is assumed that a bug or bugs may happen unintentionally. If it is happened: please inform the fact to Hitachi, Ltd. or its representative. Hitachi will try to find the reason as much as possible and inform the countermeasure when obtained.

Nevertheless Hitachi, Ltd. intends to make products with enough reliability, the product has possibility to be damaged at any time. Therefore personnel who are to install and operate the equipment has to prepare with the counter-measure such as power off switch can be operated independently of the controller. Otherwise, it can result in damage to equipment and/or serious injury to personnel.

---

# Safety Precautions

Read this manual and attached documents thoroughly before installing, operating, maintaining and inspecting this unit for proper use. Be sure to use this unit with sufficient knowledge of the equipments, all safety information and precautions. Also, make sure to deliver this manual to the person in full charge of maintenance.

In this manual, safety cautions are classified as either “Danger” or “Caution” depending on the level of care required.



: Cases in which this unit may, if handled incorrectly, cause a dangerous situation, resulting in possible serious or fatal injury.

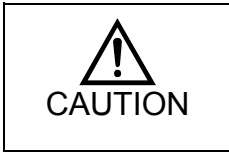

: Cases in which this unit may, if handled incorrectly, cause a dangerous situation resulting in possible minor to moderate injury or property damage.

Be aware that even the cases classified as  CAUTION can lead to a serious consequence under certain circumstances.

In either case, the instructions contain important information and must be followed.

Prohibitions and requirements are indicated by the following icons.



: Indicates prohibitions (things that users must not do). For example,  indicates that open fire is prohibited.



: Indicates requirements (things that users must do). For example,  indicates that grounding is required.

## 1. Installation

### CAUTION

- Use this unit in an environment as described in the catalogue and this manual.  
Electric shock, fire or malfunction may be caused if this unit is used in an environment with high temperature, high humidity, excessive dust, corrosive gases, vibration or shock.
- Install this unit in accordance with the instructions in this manual.  
Improper installation may cause this unit to fall off, develop troubles or malfunction.
- Never allow foreign matters such as wire chips to enter this unit.  
They may cause fire, failure or malfunction,

---

## 2. Wiring



### REQUIRED

- Always ground this unit (FE terminal).  
Failure to ground may cause electric shock or malfunction.



### CAUTION

- Power supply to be connected to this unit must meet the rating.  
Connecting a higher or lower power supply may cause fire.
- Wiring must be conducted by a qualified technician.  
Improper wiring may cause fire, failure or electric shock.

## 3. Precautions for Use



### DANGER

- To reduce the risk of electric shock, never touch the terminals while the power is on.
- Emergency stop circuit, interlock circuit and other related circuits must be assembled outside the programmable controller (hereinafter referred to as “PLC”). Otherwise, PLC may develop troubles that can cause damage to equipment or accident.  
Never interlock this unit with the external load via the relay drive power supply of the relay output module.



### CAUTION

- Make sure of safety to perform operations including program change, forced output and RUN/STOP.  
Erroneous operation may cause damage to equipment or accident.
- Follow the instructed steps to supply power to this unit in order to reduce the risk of malfunction that may cause damage to equipment or accident.

## 4. Maintenance



### DANGER

- To reduce the risk of explosion and fire, never connect the ⊕ and ⊖ on the battery in reverse. Also, never charge, disassemble, heat, place in fire, or short circuit the battery.



### PROHIBITED

- Never disassemble or modify this unit.  
Such attempt may cause fire, failure or malfunction.



### CAUTION

- Make sure to turn off the power supply before installing or removing this unit.  
Installation/removal while the power is supplied may cause electric shock, failure or malfunction.

List of Revision History

No.	Description of Revision	Date of Revision	Manual No.

***MEMO***



# Table of Contents

## USERS MANUAL

Chapter 1	Features	1 - 1 to 1 - 14
1.1	Features	1 - 1
1.2	Web communication function	1 - 11
1.3	Sample use of Web Controller	1 - 12
1.4	Sample Web Pages	1 - 13
Chapter 2	Getting started	2 - 1 to 2 - 3
Chapter 3	Names of Parts and Functions	3 - 1 to 3 - 8
3.1	10 points unit	3 - 1
3.2	23 points unit	3 - 2
3.3	Input/Output terminals Configuration and Connection	3 - 4
3.4	Operation Mode Settings Switch	3 - 6
3.5	Communication Port	3 - 8
Chapter 4	Preparation	4 - 1 to 4 - 8
4.1	Equipment Preparation	4 - 1
4.2	Network Preparation	4 - 2
4.3	Network Connection Check	4 - 5
4.4	On-line Connection of LADDER EDITOR for Windows	4 - 6
Chapter 5	Access to Web pages	5 - 1 to 5 - 15
5.1	Web server function	5 - 1
5.2	Access to Web pages	5 - 3
5.3	Access to default Web pages	5 - 5
Chapter 6	What users can do with a Web browser	6 - 1 to 6 - 14
6.1	Super User Registration	6 - 1
6.2	System Configuration	6 - 2
6.3	Browsing Web pages	6 - 9
6.4	E-mail Settings	6 - 14
Chapter 7	E-mail Sending Function	7 - 1 to 7 - 2
7.1	E-mail sending function	7 - 1
7.2	User program sample for sending e-mails	7 - 2
Chapter 8	E-mail Settings	8 - 1 to 8 - 3
8.1	E-mail settings	8 - 1

<b>Chapter 9</b>	<b>Ethernet Communication</b>	<b>9 - 1 to 9 - 6</b>
9.1	Ethernet communication function .....	9 - 1
9.2	Ethernet task code communication .....	9 - 1
9.3	Ethernet message communication .....	9 - 2
<b>Chapter 10</b>	<b>Serial Port Communication</b>	<b>10 - 1 to 10 - 10</b>
10.1	Serial port communication function .....	10 - 1
10.2	General purpose communication .....	10 - 1
10.3	Active-HIPROTOCOL .....	10 - 3
10.4	Passive-HIPROTOCOL .....	10 - 7
<b>Chapter 11</b>	<b>Network Settings</b>	<b>11 - 1 to 11 - 12</b>
11.1	DNS client function .....	11 - 1
11.2	Current Time Retrieval function .....	11 - 2
11.3	SNMP(Simple Network Management Protocol) .....	11 - 3
<b>Chapter 12</b>	<b>Super User Registration</b>	<b>12 - 1 to 12 - 7</b>
12.1	Registration of Super User .....	12 - 3
12.2	Configuration of authorization .....	12 - 4
12.3	Password change for System Administrator .....	12 - 6
12.4	Remarks .....	12 - 7
<b>Chapter 13</b>	<b>System Configuration</b>	<b>13 - 1 to 13 - 75</b>
13.1	10 points type (EH-WD10DR) .....	13 - 2
13.1.1	Web File Registration .....	13 - 4
13.1.2	IP Address Registration .....	13 - 10
13.1.3	Mail Settings .....	13 - 12
13.1.4	Ethernet Protocol Settings .....	13 - 15
13.1.5	Serial Port Settings .....	13 - 19
13.1.6	ID/Password Settings .....	13 - 24
13.1.7	Change password for mail settings .....	13 - 31
13.1.8	Change password for I/O Set .....	13 - 32
13.2	23 points type (EH-WA23DR) .....	13 - 33
13.2.1	Web file registration area settings .....	13 - 35
13.2.2	Web file registration .....	13 - 40
13.2.3	IP Address registration .....	13 - 46
13.2.4	Mail settings .....	13 - 48
13.2.5	Ethernet protocol settings .....	13 - 51
13.2.6	Serial port settings .....	13 - 55
13.2.7	ID/Password settings .....	13 - 61
13.2.8	Change password for mail settings .....	13 - 68
13.2.9	Change password for I/O Set .....	13 - 69
13.2.10	Analog input/output settings .....	13 - 70
13.2.11	SNMP .....	13 - 72
13.2.12	Setting file Upload/Download .....	13 - 74
13.3	Remarks .....	13 - 75

Chapter 14	Web Controller Extension HTML Tags	14 - 1 to 14 - 17
	14.1 Extension HTML tags	14 - 1
	14.2 Types of Extension tags	14 - 2
	14.3 I/O monitor tags	14 - 3
	14.4 Login information transfer tags	14 - 12
	14.5 Logout tags	14 - 13
	14.6 I/O pass tags	14 - 14
	14.7 Extension tag error code	14 - 16
	14.8 Remarks for HTML tags	14 - 17
Chapter 15	Setting values from a Web browser to data memory	15 - 1 to 15 - 12
	15.1 Data memory setting program	15 - 1
	15.2 HTML statement to pass an argument to the data memory setting program	15 - 2
	15.3 A settable value to data memory	15 - 5
	15.4 Remarks	15 - 5
	15.5 HTML tag examples for data memory setting	15 - 6
Chapter 16	List of Specifications	16 - 1 to 16 - 17
	16.1 General Specifications	16 - 1
	16.2 Dimensions Diagram	16 - 2
	16.3 Function Specifications	16 - 3
	16.4 Ethernet Port Specifications	16 - 5
	16.5 Web Communication Specifications	16 - 7
	16.6 E-mail Specifications	16 - 8
	16.7 Serial Port Specifications	16 - 9
	16.8 Calculation Specifications	16 - 11
	16.9 I/O Specifications	16 - 12
	16.10 I/O Numbers	16 - 17
Chapter 17	Installation / Wiring	17 - 1 to 17 - 7
	17.1 Installation	17 - 1
	17.2 Wiring	17 - 3
Appendix 1	Cable Specifications	Appendix - 1 to Appendix - 5
Appendix 2	Initialization to factory setting	Appendix - 7 to Appendix - 8
Appendix 3	HTML sample files for Web pages	Appendix - 9 to Appendix - 13
Appendix 4	Sample programs for TCP/IP	Appendix - 15 to Appendix - 19

# Chapter 1 Features

## 1.1 Features

■ An all-in-one controller with an easy installation

Web Controller is an all-in-one controller with a power supply, CPU, memory, and input/output circuit for external signals, and is equipped with an Ethernet communication interface as a standard.

The 23 points type unit has two channels analog inputs and one channel analog output and can control from small range to medium range control system by connecting MICRO-EH expansion units like 8 points, 14 points, 16 points, 28 points, analog type and RTD type.

In addition to the unit's intelligent control, it also supports the construction of a monitoring system using a personal computer (PC) connected to a network either by a Web browser or by communication.

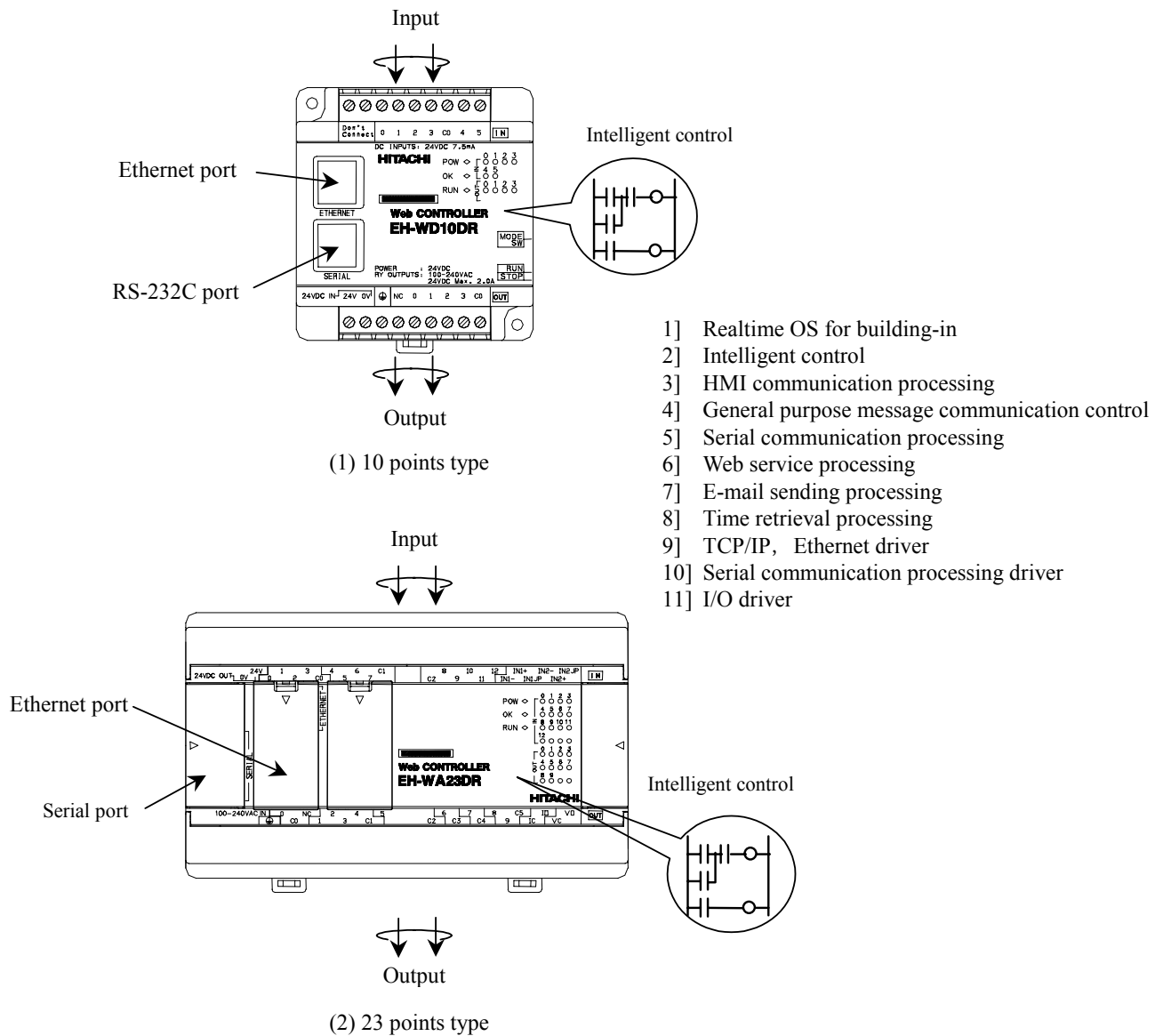

Figure 1.1 All-in-one controller

■ Compact size for easy installation and maintenance

The size of 10 points type is as small as 75 (W) x 80 (H) x 47 mm (D), and is ideal as a built-in device for an empty space of machines and equipment.

23 points type is using removable terminal blocks for external input/output interface and can save worker cost for wiring or miss wiring.

In addition, Web controller is DIN Rail mountable. So it is not necessary to purchase special metal fittings. The removal of the unit is easy when it is required for a wiring or maintenance. Of course, it is possible to fasten the unit with screws.

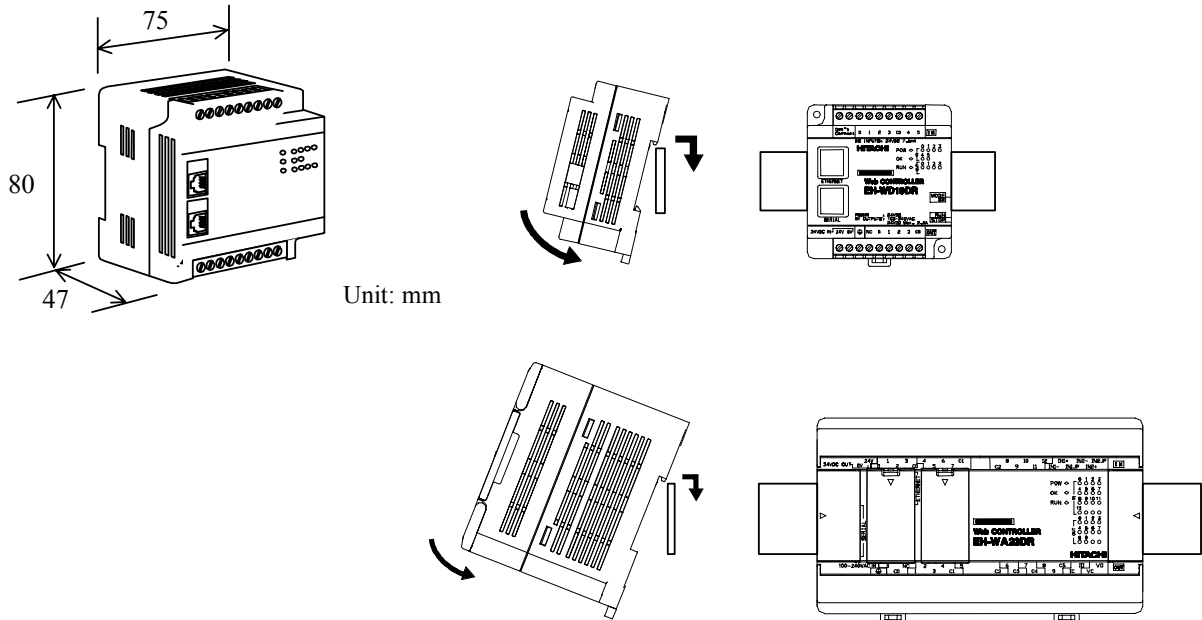

Figure 1.2 Compact framework adequate for the built-in

■ Small process monitoring system by using analog input/output functionality

23 points unit has voltage/current selectable two channels analog inputs and one channel analog output. It is possible to realize small process monitoring system by using high performance analog functions like 12 bits resolution and less than plus minus 1% accuracy.

■ User programmable intelligent control function

Web Controller has input units for loading the ON/OFF information from equipment or from sites, and has output units which can be turned ON or OFF from an upper PC as a standard.

As basic functions, it also has a programmable controller operated by software prepared by users for a signal processing unit (logic unit / control unit) of a logical circuit (hard-wired logic) which consists of a relay, timer and counter. According to the input conditions including push switches and sensors used by equipment / sites, the output load of motors and pilot lamps is controlled.

Control Function of a Web Controller

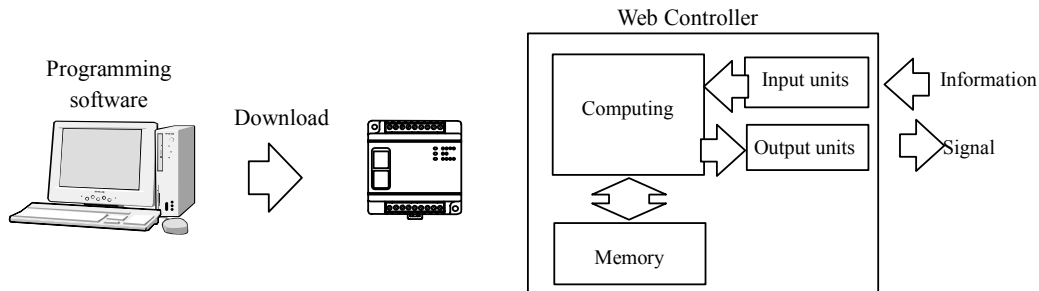

Figure 1.3 Controller Function

Programmable Controller:

Its acronym, **PLC**, is used as a generic name of the Programmable Logic Controller. It is also referred to as “sequencer,” as it is a controller which handles sequence.

## User Programmable Software

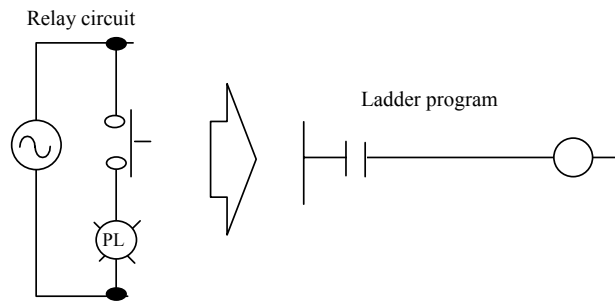

Figure 1.4 User Program

Ladder program:

A software language which expresses relay circuits schematically. It is called “ladder program,” because its structure looks like a ladder.

The lines on the left and right ends express the bus which corresponds to a power wire of a relay. Input conditions should be written on the left side, and the operational output should be written on the right end.  
ON/OFF:

It indicates the condition of current at contact points and coils, and “ON” indicates that the power is supplied, and “OFF” indicates that it is not supplied.

## Equipped with arithmetic operation function

**Web Controller** has an arithmetic operation function which is used for the ON/OFF count, and is also equipped with an IO memory. It serves as a remote I/O, and also enables the automatic control on the spot according to the specified conditions and orders.

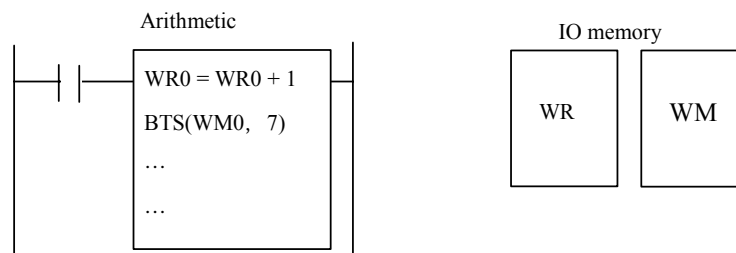

Figure 1.5 Arithmetic operation function

IO memory:

PLC is equipped with data memory which uses 16 bits (1 word) as a unit. It is called “internal output” or “register.”

## Programs are maintained without the help of batteries

User programs are stored on a flash ROM to avoid the loss of valuable user programs in case of power failure.

Flash ROM:

It is an electronically rewritable read only memory which keeps stored data even after the power is turned off. EEPROM is rewritable around 10,000 times, but a flash ROM is rewritable as many as 100,000 times. Traditionally, PLC programs were stored on SRAMs backed up with batteries, but using flash ROMs for the purpose has become more common.

## Digital filter is adopted for setting of the input response time

The input unit of Web Controller removes chattering, and adjusts process delay time of filters. Settings are flexible between 0-20ms by 0.5ms.

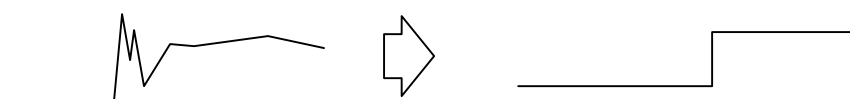

Figure 1.6 Digital filter

■ Web communication function

Web Controller is equipped with a function to register HTML (Hyper Text Markup Language) files and the Web server function. Web Controller enables users to browse and update the HTML files in the unit using a Web browser.

In addition, Web Controller is equipped with several dedicated CGI (Common Gateway Interface). Using these dedicated CGI, users can read and write values on data memory of Web Controller via a Web browser without using special software.

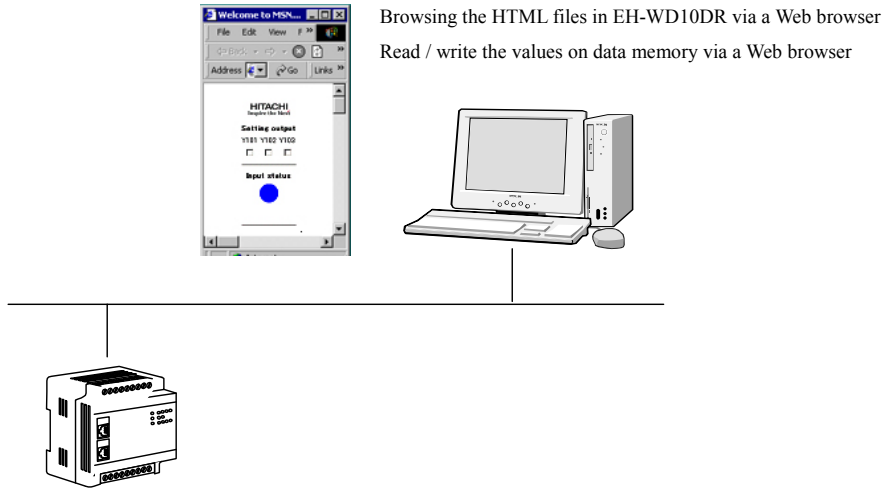

Figure 1.7 Web service

Browsing the HTML files in Web Controller via a Web browser

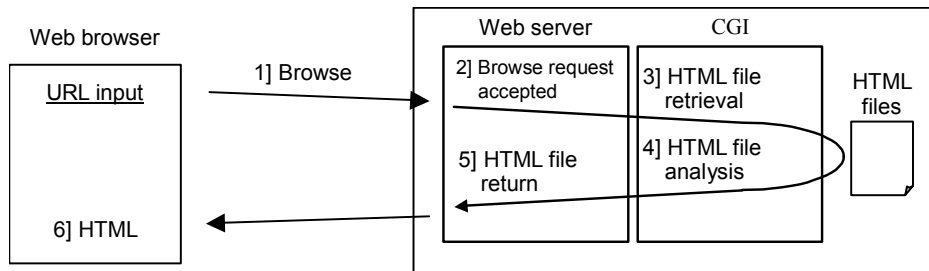

Figure 1.8 Browsing Web pages

Reading out the values on data memory via a Web browser

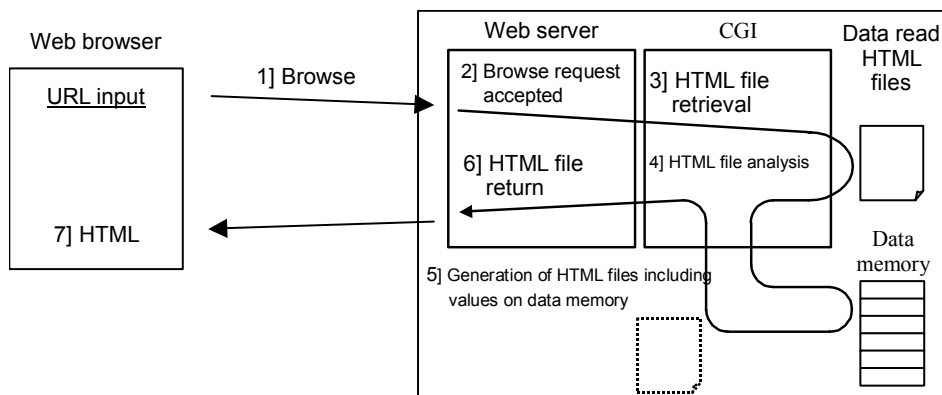

Figure 1.9 Reading out the values of data memory via a Web browser

Writing values on data memory via a Web browser

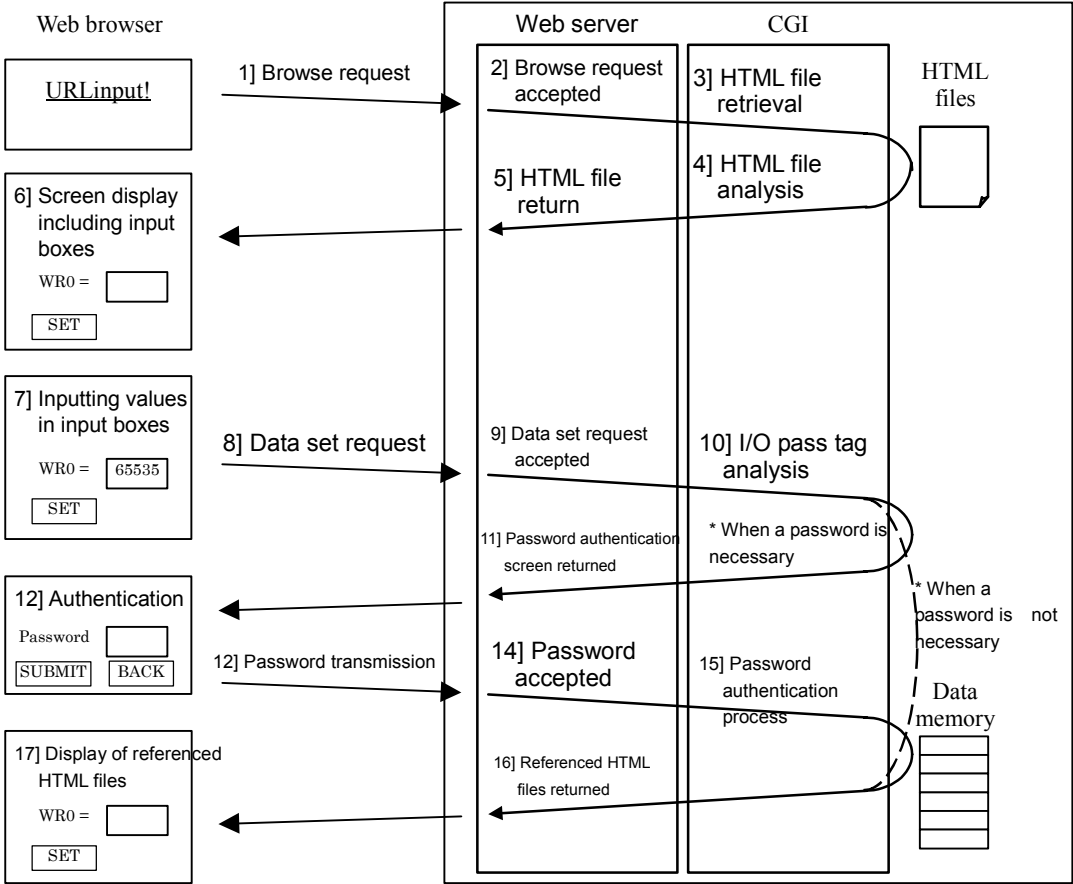

Figure 1.10 Setting values on data memory via a Web browser



**Web browsing, User ID/Password, I/O Set password**

It is possible to put an access control on the files stored in Web Controller using a User ID/Password. An access control enables users to differentiate files which are browsable by all users from those which are browsable only by specified users. It is also possible to put a password protection for setting values on data memory.

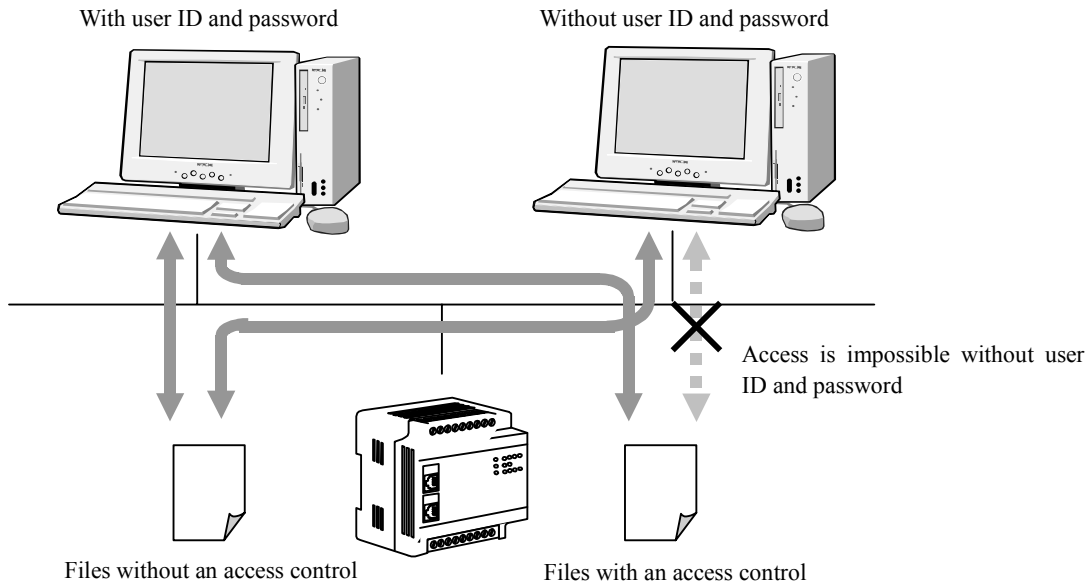

Figure 1.11 Accessing files with an access control

**Setting of various operation and update Web contents**

The setup page for Web Controller, “System Configuration” enables users to configure the IP address of Web Controller, various communications and operation and the update of Web contents. The “System Configuration” page is protected with IDs and passwords for Super Users to provide a better security for users.

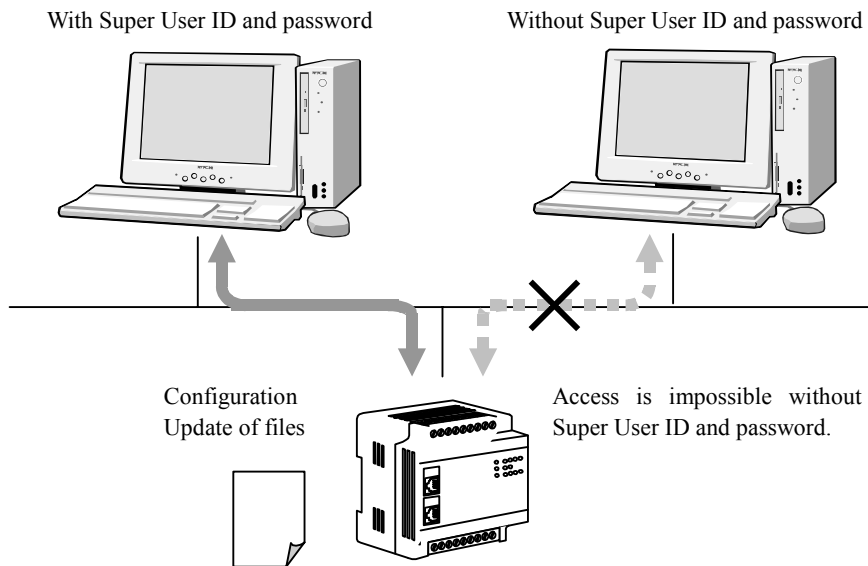

Figure 1.12 Access image to the System Configuration page

### Super User Registration

Super User ID and password are required to configure Web Controller in the System Configuration page. There is a dedicated screen for the registration and administration of IDs and passwords for Super Users. The configuration page is called “Super User Registration” page. It is possible to register four Super Users. It is also possible to specify the items (authorization) which can be set by each Super User to provide better security and flexible usages.

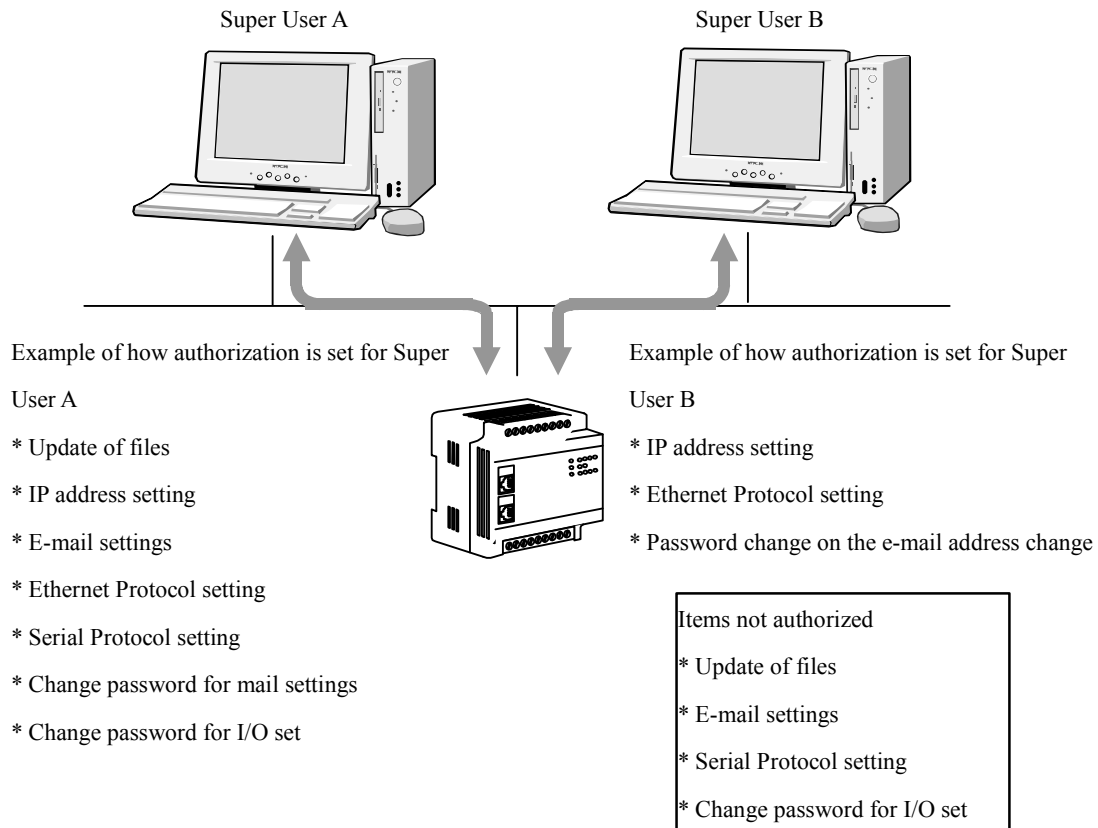

Figure 1.13 Sample setting of privileges for each Super User (10 points type)

■ Convenient E-mail sending function for sending an alert

Web Controller is equipped with SMTP. According to the input ON/OFF conditions or the judgment by the system on the combination of ON/OFF status, E-mails are easily sent either to the mail server of intranet or Internet for an easy construction of an alert system.

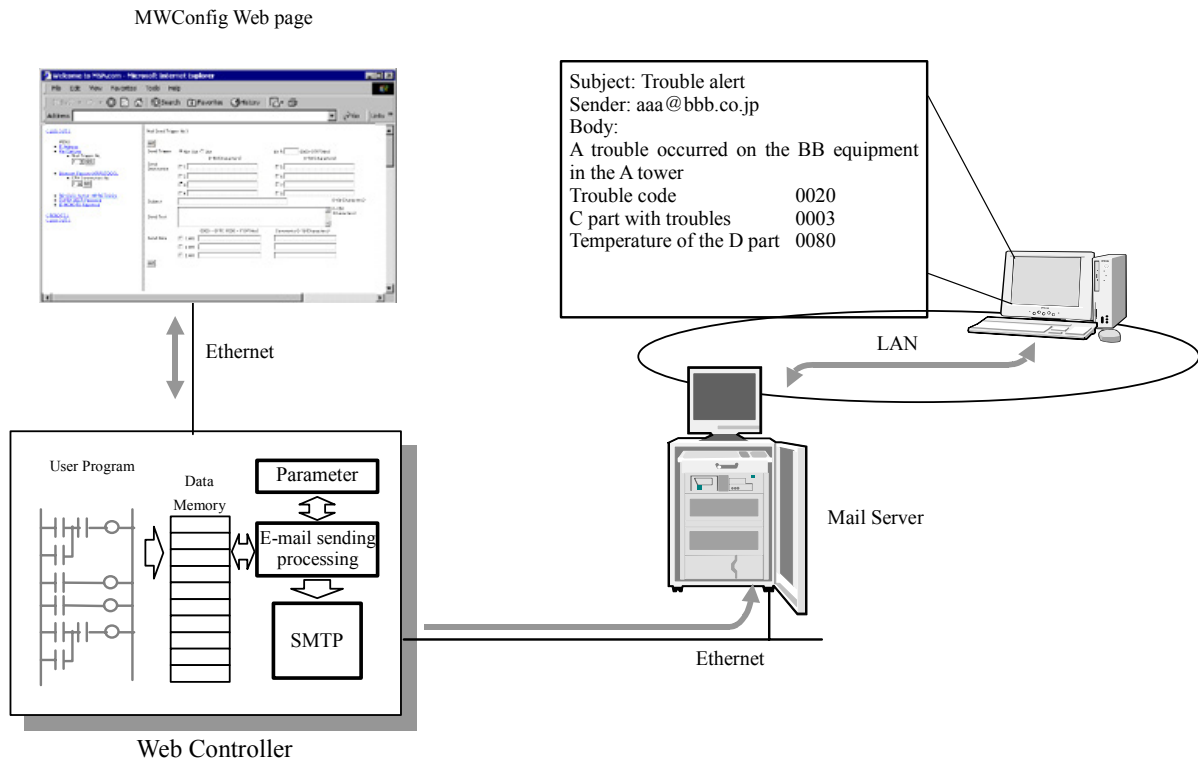

Figure 1.14 E-mail sending function

■ Network communication function supporting system construction

(1) Supports general purpose HMI (Human Machine Interface) products

It is possible to use Web Controller with products including SCADA software or touch panel which are compatible Hitachi programmable controllers. (Communication with general-purpose HMI products is handled by commands and responses.) It is possible to construct a remote monitoring system without developing new software for an upper host.

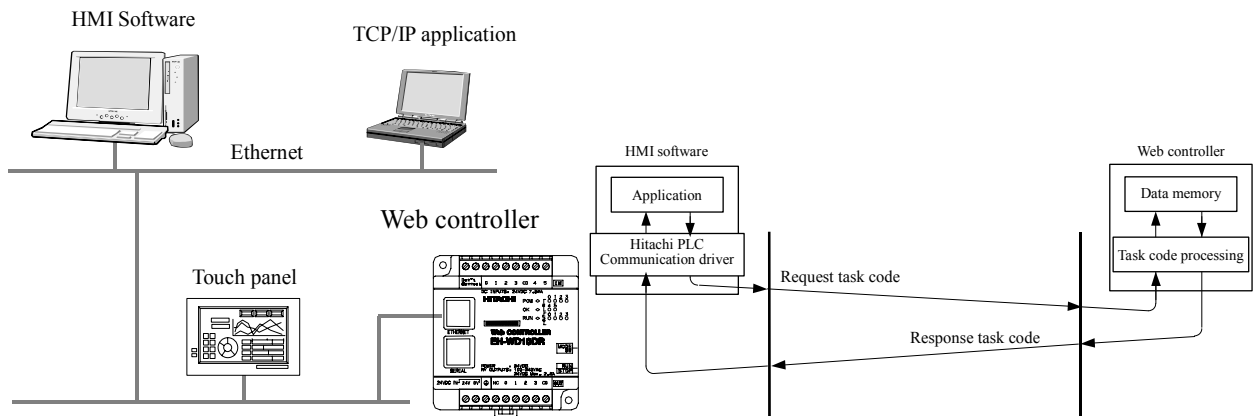

Figure 1.15 Supports general purpose HMI products

(2) Supports general purpose message communication

In addition to the command and response communication with general-purpose HMI products, message communication which enables users to send events from Web Controller to an upper host is also supported. Communication procedures are specified according to the system including the transmission of the values stored on the specified I/O memory in a constant cycle.

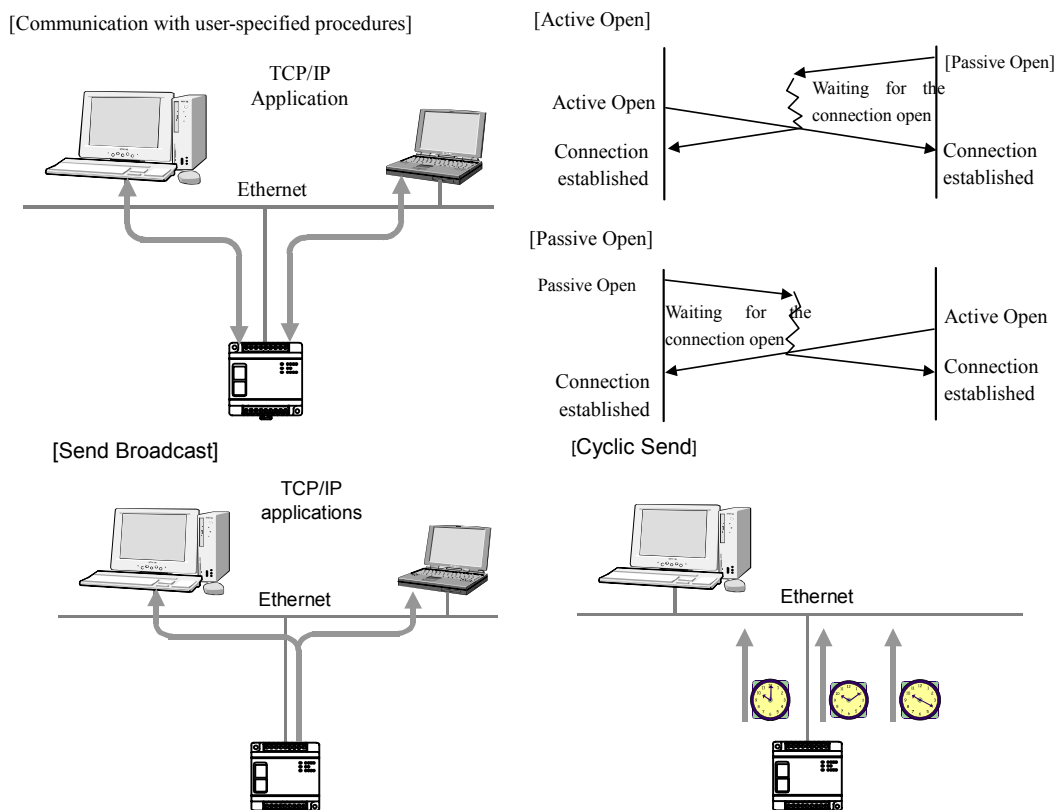

Figure 1.16 Message communication

■ Serial port communication function

Equipped with serial port communication function for an easy monitoring of controllers with serial ports in existing facility. Only by connecting Web Controller with an existing controller with a dedicated cable and by configuring the unit, acquisition and exchange of data to and from existing controllers is possible.

Web Controller can be used as a communication gateway to an upper host on a network by using the network function.

10 points unit supports RS-232C and 23 points unit supports RS-232C and RS-422/485 as serial port.

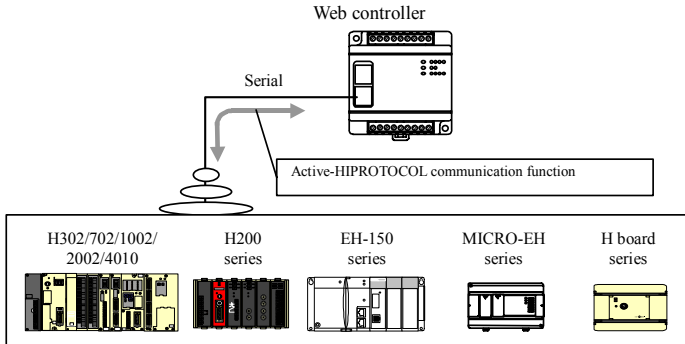

It is convenient in such cases:

Establishment of a monitoring system using an existing network is planned, however,

- Minimum changes to an existing system are desirable.
- There is no spare slot for the implementation of Ethernet modules in existing controller.
- The PLC used at The site does not have an Ethernet module as an option.
- It is impossible to make a significant investment in the network introduction.

Figure 1.17 Serial port communication function

■ Time retrieval function

Equipped with SNTP (Simple Network Time Protocol) client function which retrieves the current time from the NTP server or SNTP server on a network. The current time retrieved from the server is stored on a special internal output area (WRF00B - WRF00F0), and the clock data can be used in user programs. This function is convenient for data logging with time stamp.

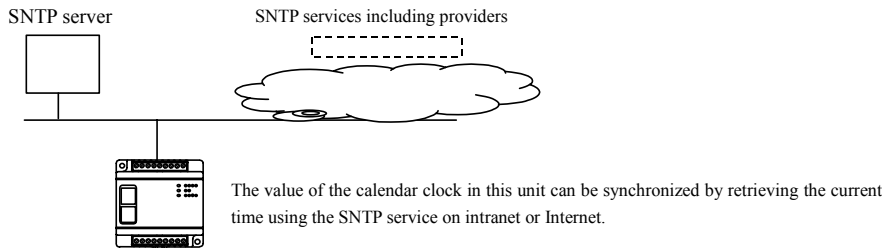

Figure 1.18 SNTP client function

SNTP(Simple Network Time Protocol):

Compared to NTP (Network Time Protocol) service, which is widely used on Internet for clock synchronization, its function is limited to time synchronization.

■ Part of data memory WR values are stored in “FROM”.

Part of data memory WR values (in case of 10 points unit: values between WR3F80 to WR3FFF and in case of 23 points unit: values between WRC380 to WR C3FF), which are part of data memory, can be stored on FROM. Usually, these values cleared when the power is turned ON/OFF, or the RUN is switched between RUN and STOP. However, the values between these areas are stored on Flash ROM, and are read from the Flash ROM after the switch turns to RUN, so they are not cleared even when the power is turned ON/OFF or RUN is switched between RUN and STOP. This function is convenient when handling invariable data.

In order to store values of data memory WR into Flash ROM, user program should indicate the storing timing by using WRF03A. The system software of Web controller stores these values into Flash ROM after checking the bit0 of special internal output area WRD01A is “1” and detecting a difference between Flash ROM values and data memory values.

Table 1.1 The range area of a data memory WR stored into Flash ROM

	10 points type	23 points type
Range	WR3F80 ~ WR3FFF	WRC380 ~ WRC3FF

### ■ SNMP agent function (only 23 points unit)

23 points type Web controller has SNMP (Simple Network Management Protocol) agent function. 23 points type Web controller can be monitored via a network by using SNMP manager software.

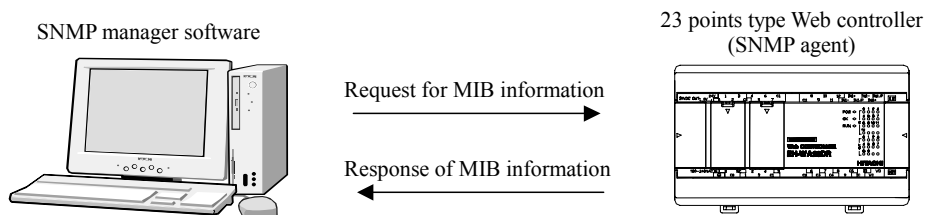

Figure 1.19 SNMP manager and agent

## 1.2 Web communication function

Web Controller is equipped with a Web server function, and with a Web communication function, which enables the following via a Web browser on a personal computer (PC).

- 1] Browsing of files registered in Web Controller
- 2] Retrieval of values stored on data memory
- 3] Setting of values stored on data memory
- 4] Registration of HTML files
- 5] Setting of various operation

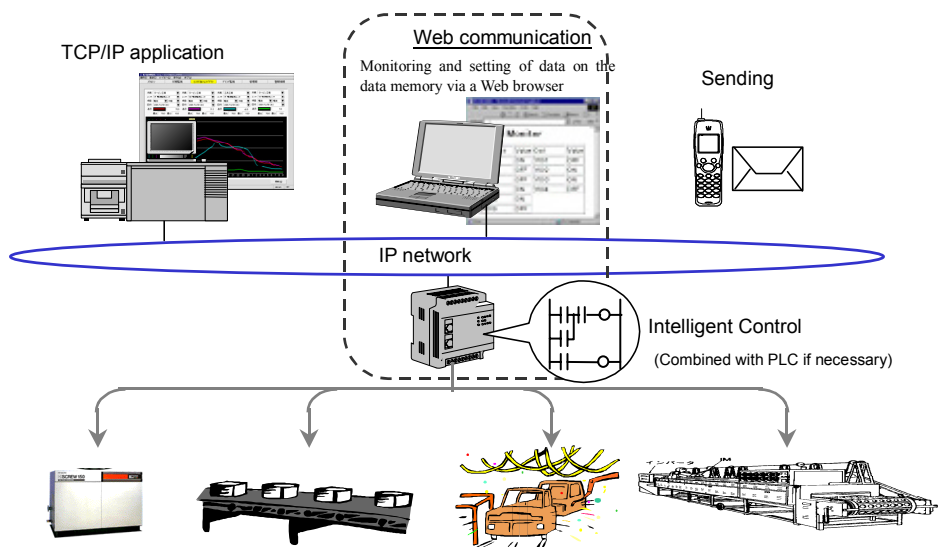

Figure 1.20 Positioning of a Web controller and Web communication function

### 1.3 Sample use of Web Controller

Using the Web communication function of Web Controller enables the following:

- Easy installation in a smaller space Networking of existing facility

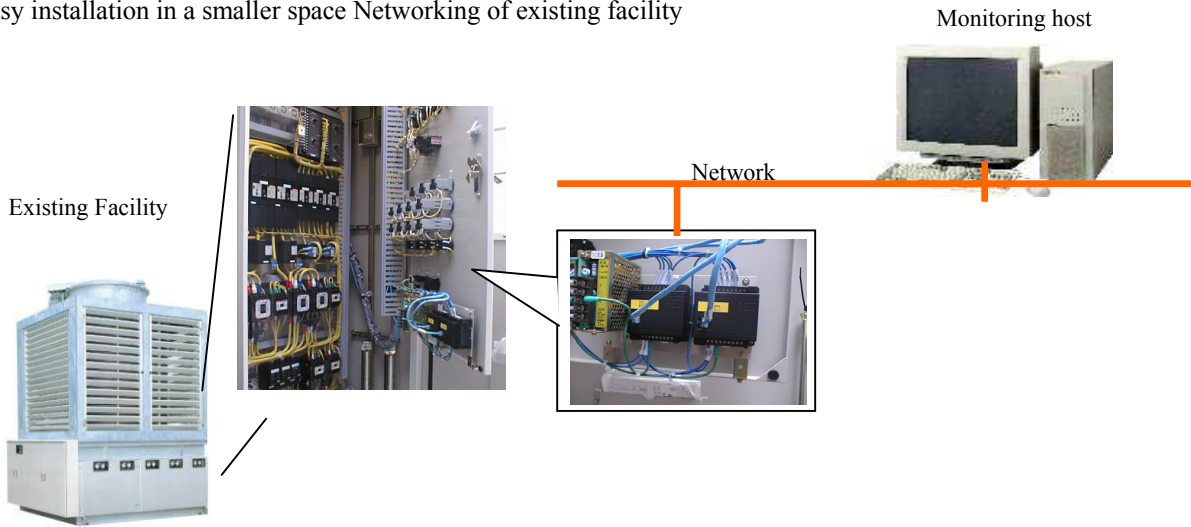
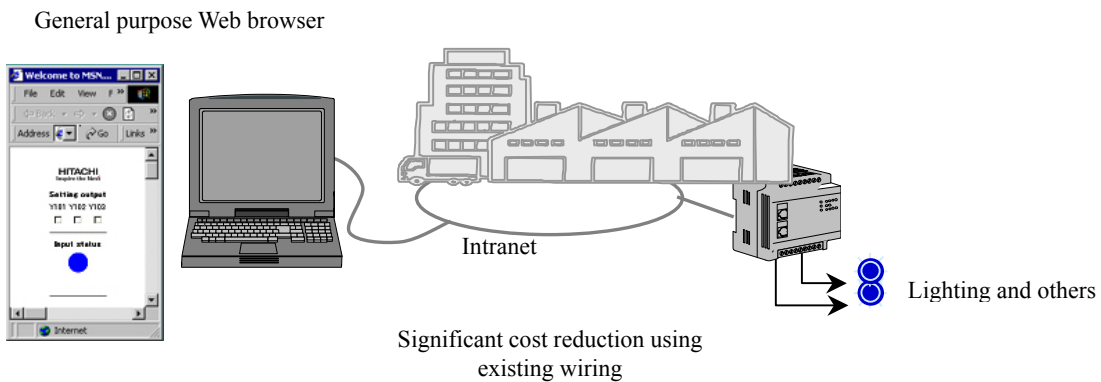

Figure 1.21 Networking of existing facility

- I/O operation from a Web browser on a PC via Ethernet



Significant cost reduction using existing wiring

Figure 1.22 I/O operation from a Web browser

- Web Controller enables I/O transmission via Ethernet

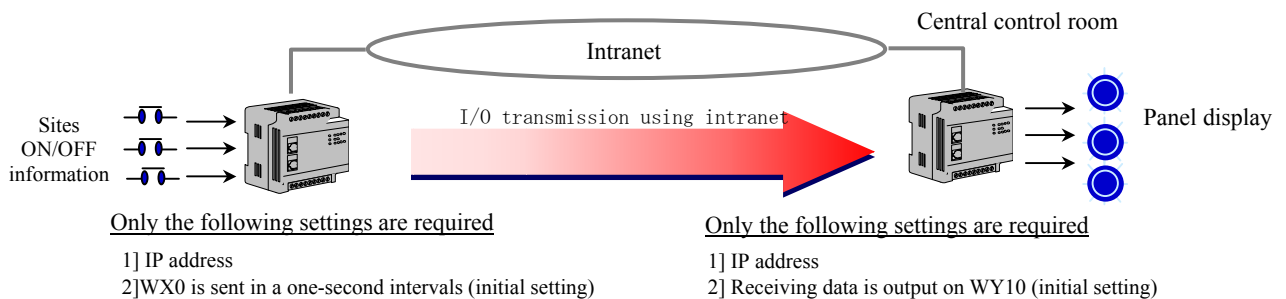
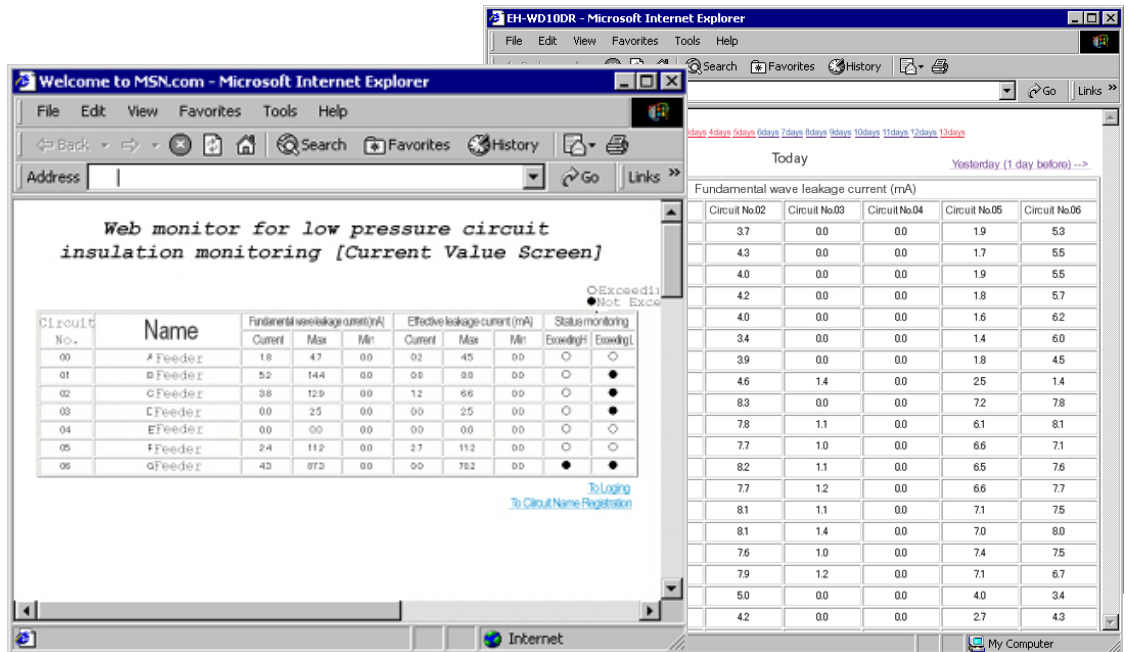

Figure 1.23 I/O transmission via Ethernet

## 1.4 Sample Web pages

(1) Tabular display of the current data monitor and logging data



(2) Bar chart display of data using JavaScript

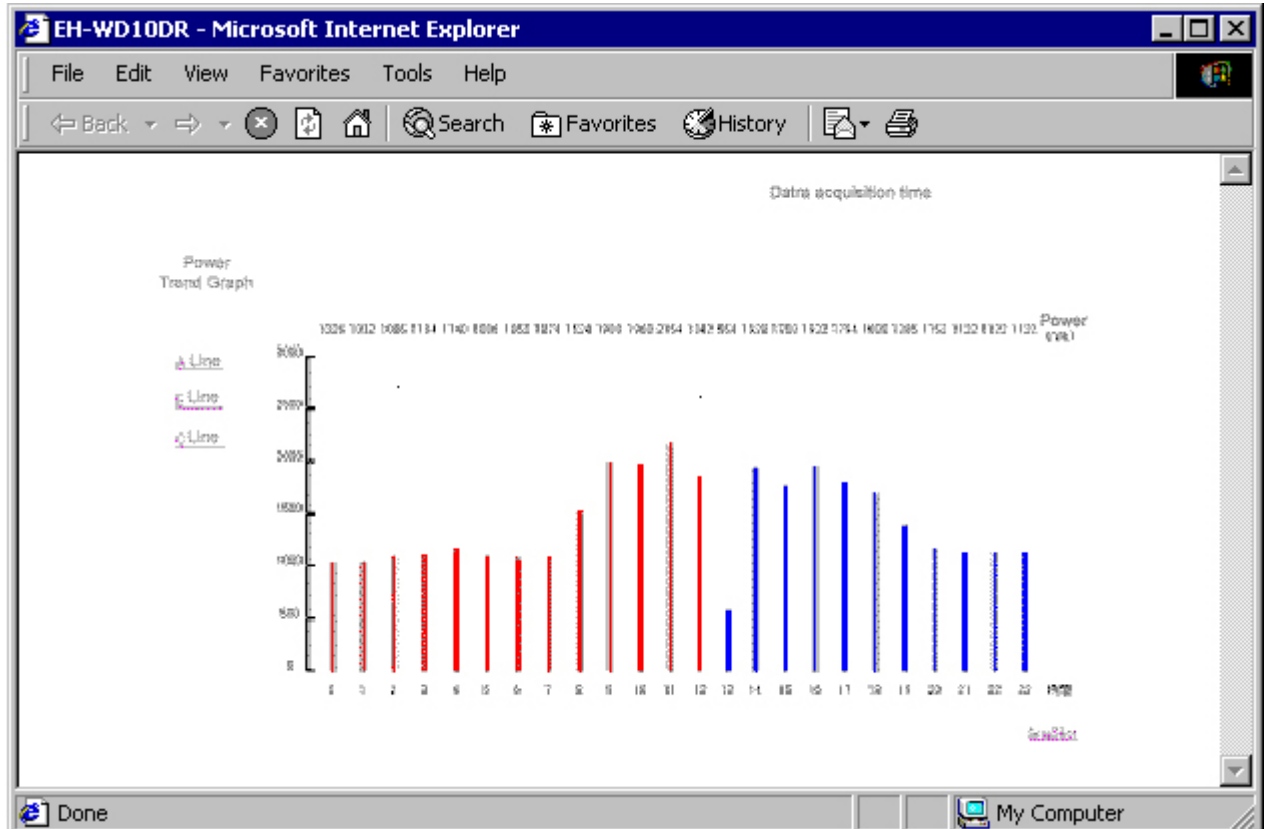



(3) Monitoring of machines / equipment's status

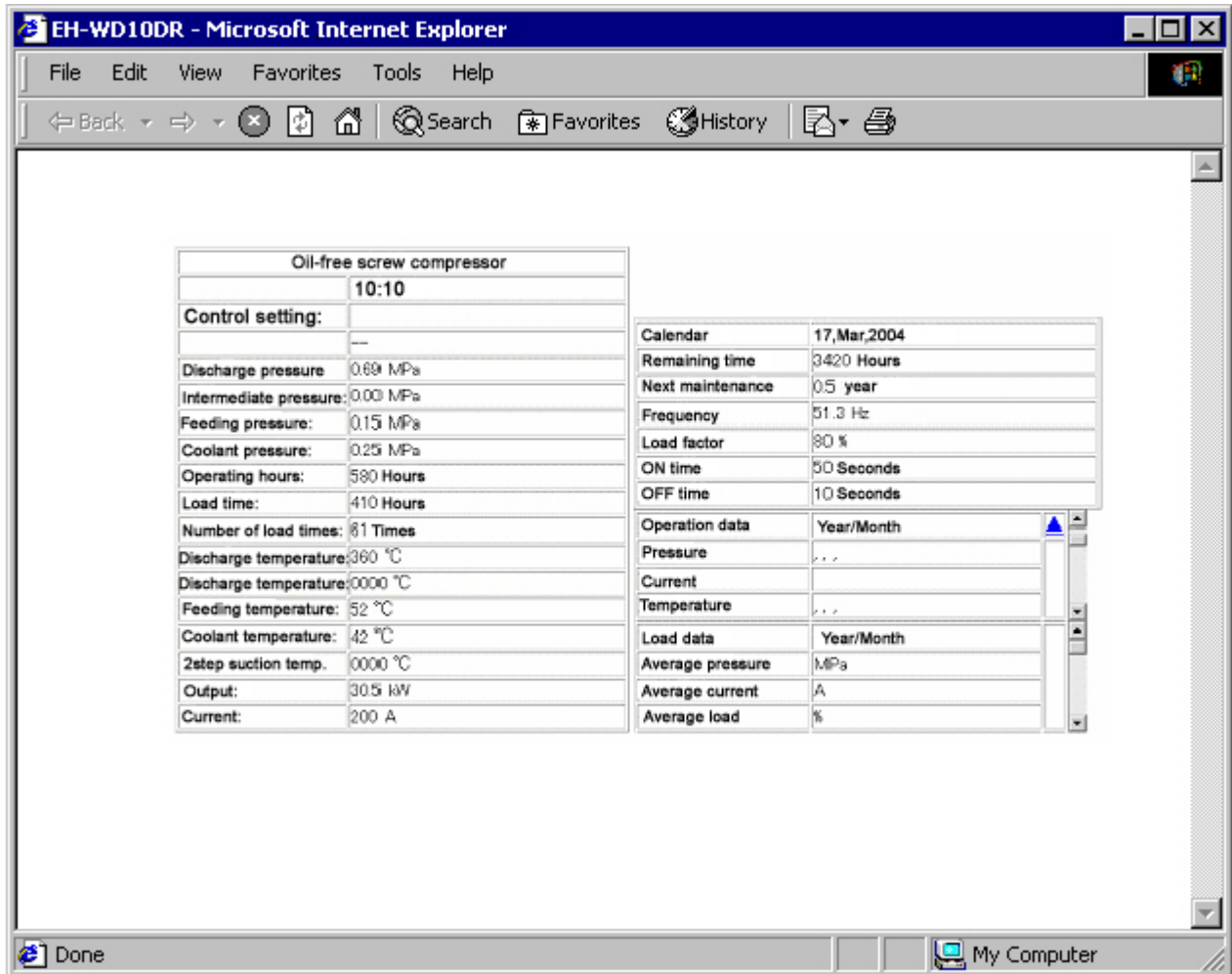

(4) Others

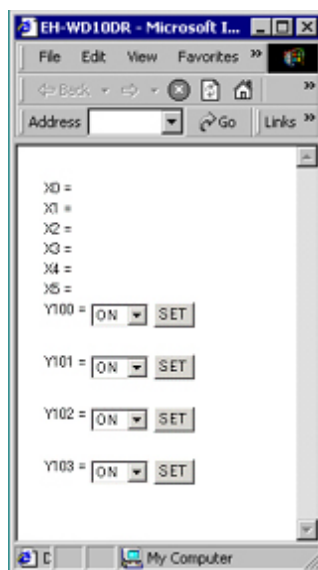

# Chapter 2 Getting started

Follow the procedures described below for the preparation and setup before using Web Controller. Set up each function as appropriate.

(1) To use Web Controller

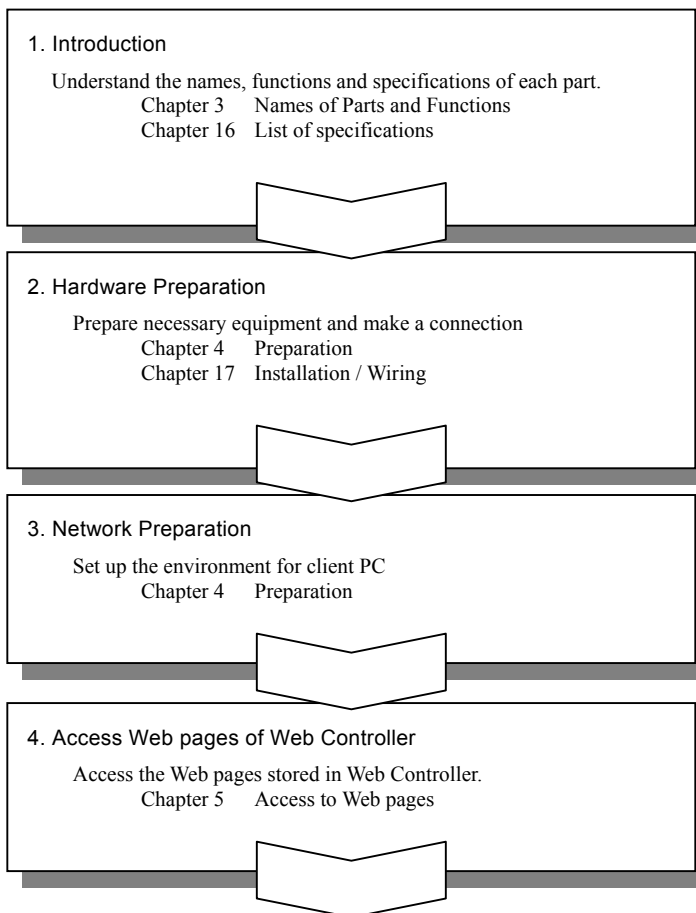

(2) To know the functions of Web Controller

**5. About the Web server functions**

What are Web server functions?

Chapter 6 What users can do with a Web browser



**6. About E-mail sending function**

What is the E-mail sending function?

Chapter 7 Sending E-mails



**7. About the mail settings function**

What is the mail setting function?

Chapter 8 Mail Setting with a Mobile Phone



**8. About the Ethernet communication function**

What is the Ethernet communication function?

Chapter 9 Ethernet communication

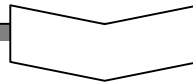

**9. About the serial port communication function**

What is the serial port communication function?

Chapter 10 Serial Port Communication

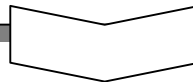

**10. About Other Network Functions**

What other convenient functions does Web Controller have?

Chapter 11 Network Setting

(3) To perform various configurations

11. Perform various configuration

How to set up

Chapter 12 Super User Registration

Chapter 13 System Configuration

(4) To prepare HTML files

12. To prepare HTML files

How to prepare HTML files

Chapter 14 Web Controller Extension HTML Tags

Chapter 15 Setting values from a Web browser to data memory

(5) To perform control

13. Prepare control programs

How to control

Refer to the "Controller Manual"!

(6) When you have troubles in controlling Web Controller

14. Check with the List or Error Messages and Troubleshooting

When noticing abnormalities

Refer to the "Controller Manual"!

***MEMO***

# Chapter 3 Names of Parts and Functions

## 3.1 10 points unit

Names of Parts and Functions	Format	EH-WD10DR
	Weight	Approx. 160g
	Current Consumption	0.15 A
	I/O Allocation	X48/Y32/Vacant 16

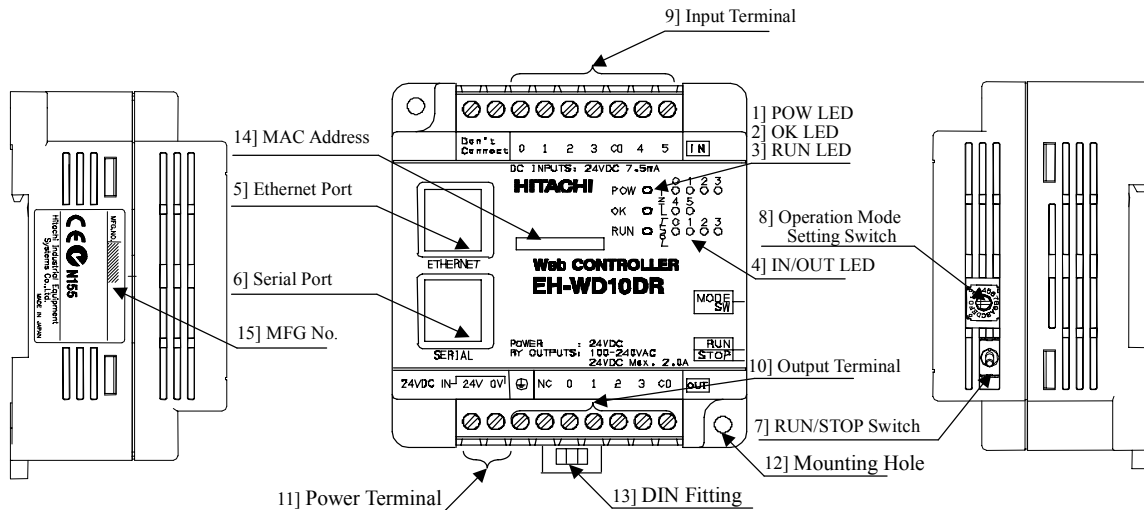

No.	Item	Description	Remarks
1]	POW LED	Lights up when power is supplied.	
2]	OK LED	Lights up during normal functioning.	
3]	RUN LED	Indicates running condition and lights up during normal running	
4]	IN/OUT LED	Indicates whether Input/Output terminals are ON (lights on) or OFF (lights off).	
5]	Ethernet port	This RJ45 socket is used as Ethernet interface. Use this port for various communications including programming software, Web server or sending E-mails.	Connect a Category 5 UTP or STP cable.
6]	Serial Port	This RJ45 socket is used as RS-232C interface. Use a Web-based configuration tool to select a communication function to be used. (Refer to "Web Controller Users' Manual, Appendix: Cable Connection Diagram" for connection diagrams.)	
7]	RUN/STOP Switch	Switches Web Controller to RUN or STOP. Slide the switch to "RUN" to run Web Controller and to "STOP" to stop it.	
8]	Operation Mode Setting Switch	Use this switch to set operation modes of Web Controller. 0: Normal Operation Mode 2: IP Address Rescue Mode 7: Factory Setting Initialized Mode	Do not set it to any other position.
9]	Input Terminal	These terminals are to connect to external input devices. One AWG14 - AWG22 (2.1 - 0.36 mm <sup>2</sup> ) wire or two AWG16 - AWG22 (1.30 - .36 mm <sup>2</sup> ) wires can be connected per terminal. I/O numbers are X000 - X005, and WX00.	
10]	Output Terminal	These terminals are to connect to external loads. Connection specifications are the same with the input terminal. I/O numbers are Y100 - Y103, and WY10.	
11]	Power Terminal	These terminals are to connect to power supply. Connection specifications are the same with the input terminal.	
12]	Mounting Hole	Use this hole to mount Web Controller directly onto a board.	
13]	DIN Fitting	Use this to mount Web Controller onto a DIN rail.	
14]	MAC Address	Indicates MAC Address of Web Controller. Use it as administrative reference of network devices.	
15]	MFG No.	Indicates the Production Lot Number of Web Controller.	

### 3.2 23 points unit

Names of Parts and Functions	Format	EH-WA23DR
	Weight	Approx. 600g
	Current Consumption	0.4 A (100V AC)
	I/O Allocation	X48/Y32/Vacant 16/WX4/WY4

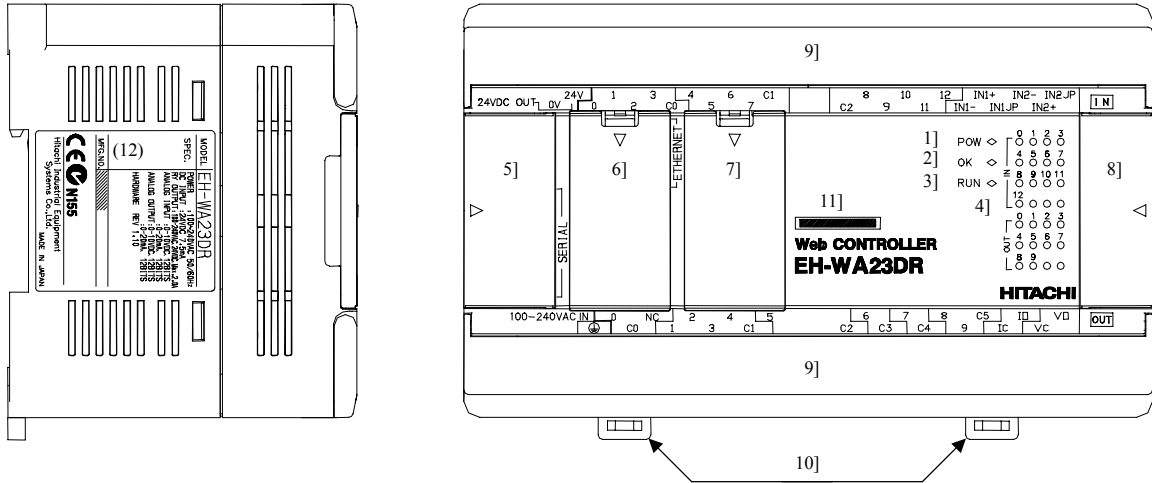

No.	Item	Description
1]	POW LED	Lights up when power is supplied.
2]	OK LED	Indicates unit condition.
3]	RUN LED	Lights up during normal running of Ladder execution.
4]	IN/OUT LED	Indicates whether Input/Output terminals are ON (lights on) or OFF (lights off).
5]	Cover of Serial port	Close this cover when serial port is not used.
6]	Covert of Ethernet port	Close this cover when Ethernet.
7]	Battery cover	Close this cover instead of battery used or unused.
8]	Covert of expansion unit connector	Close this cover instead of external unit used or unused.
9]	Terminal cover	Close these covers during operation.
10]	DIN Fitting	Use this to mount Web Controller onto a DIN rail.
11]	MAC Address	Indicates MAC Address of Web Controller. Use it as administrative reference of network devices.
12]	MFG. No.	Indicates the Production Lot Number of Web Controller.

(continue to next page)

Names of Parts and Functions		Format	EH-WA23DR
		Weight	Approx. 600g
		Current Consumption	0.4 A (100V AC)
		I/O Allocation	X48/Y32/ Vacant 16/WX4/WY4
No.	Item	Description	
13]	Mounting Hole	There are two mounting holes. Use M4 screw to mount Web Controller directly onto a cabinet.	
14]	Removable terminal blocks	There are four removable terminal blocks. There are 12 screws on each terminal block.	
15]	Fixing terminal block screw	There are two screws on each terminal block to fix the removable terminal block. Use Web Controller with fixing these screws.	
16]	Terminal screw	These are terminals for power, FG and external input/output wiring. There are 48 terminals in total. One terminal can have one of AWG14 to AWG22 (2.1 to 0/36mm <sup>2</sup> ) wire or two of AWG16 to AWG22 (1.3 to 0.36 mm <sup>2</sup> ) wires. Refer "Input/output terminal specification, assignment and wiring "for the detail of terminal assignment.	
17]	RUN/STOP Switch	Switches Web Controller to RUN or STOP. Slide the switch to "RUN" to run Web Controller and to "STOP" to stop it.	
18]	Serial port	RJ45 type socket is used. In order to select the communication function of serial port, use Web base configuration tool built-in Web controller via Ethernet port. Refer "Web controller user's manual Appendix diagram of cable wiring".	
19]	Operation Mode Setting Switch	Uses this switch to set operation modes of Web Controller. Use web controller with all off position for normal operation mode.	
20]	Ethernet port	RJ45 type socket is used. Connect UTP or STP cable category 5. Use this port for several communication services like programming software, Web server and e-mail sending etc.	
21]	Communication status LED of Ethernet	Indicates the tree kinds of Ethernet communication states with LED. LNK LED: Lights up when link status is established. TX LED: Lights up when packet is sent. RX LED: Lights up when packet is received.	
22]	Battery holder	This is the holder for EH-MBAT*.	
23]	Battery connecter	This is the connecter to connect EH-MBAT*.	
24]	Expansion unit connecter	This is the connecter to connect expansion unit cable.	

\*EH-MBAT is sold as option.



### 3.3 Input/Output Terminals Configuration and Connection

(1) 10 points type

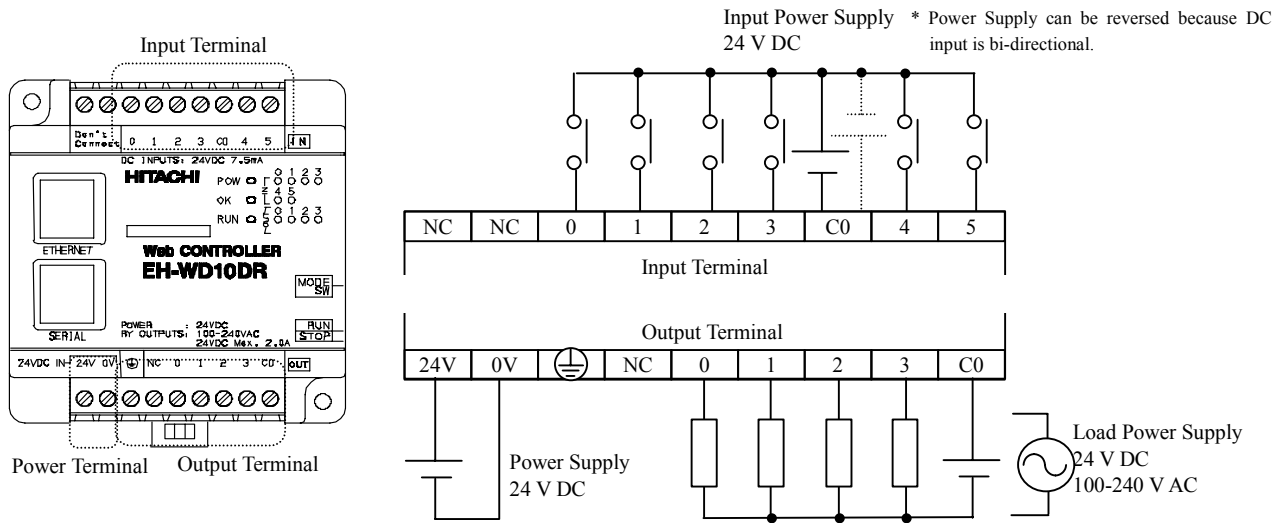
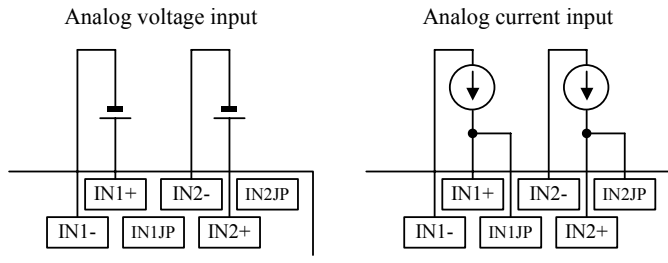
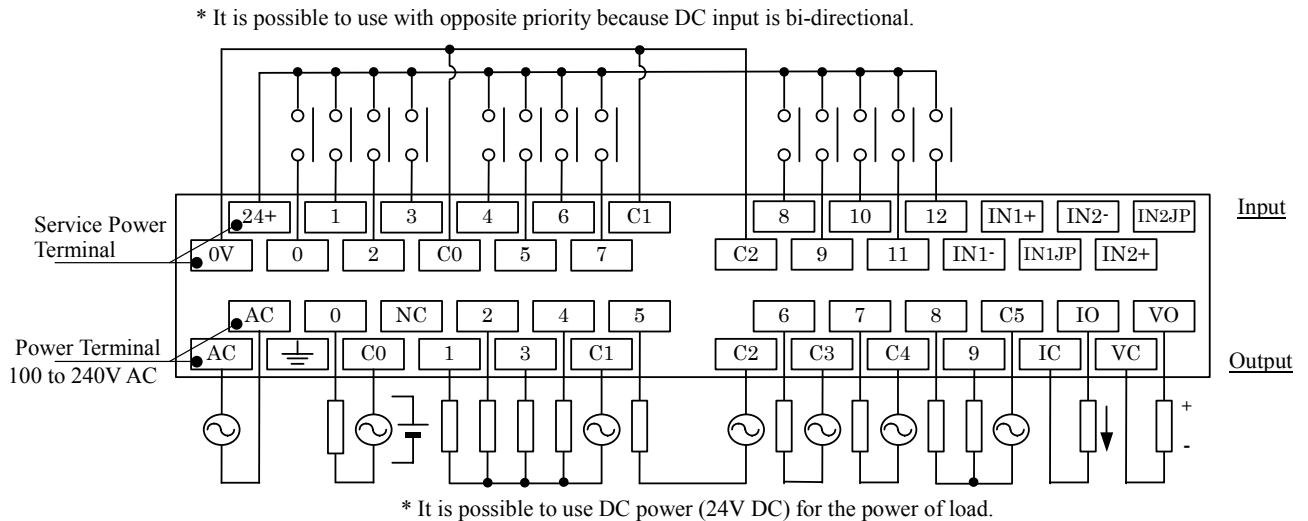

Figure 3.1 Terminals Configuration and Connection

(2) 23 points type



Select current or voltage type by using system configuration.

Figure 3.2 Terminal assignment and wiring

■ Wiring of analog input/output terminal.

This unit handles very sensitive signal with analog input/output terminal. Please take care for reduction of noise impact with external wiring. Refer the following information for wiring.

- Use sealed wire for input signal.
- Separate from different voltage power line and signal line.
- Fundamentally connect sealed line to ground with single end. But some case it may be effective to connect sealed line to minus side of signal.

Please select the best method according the condition.

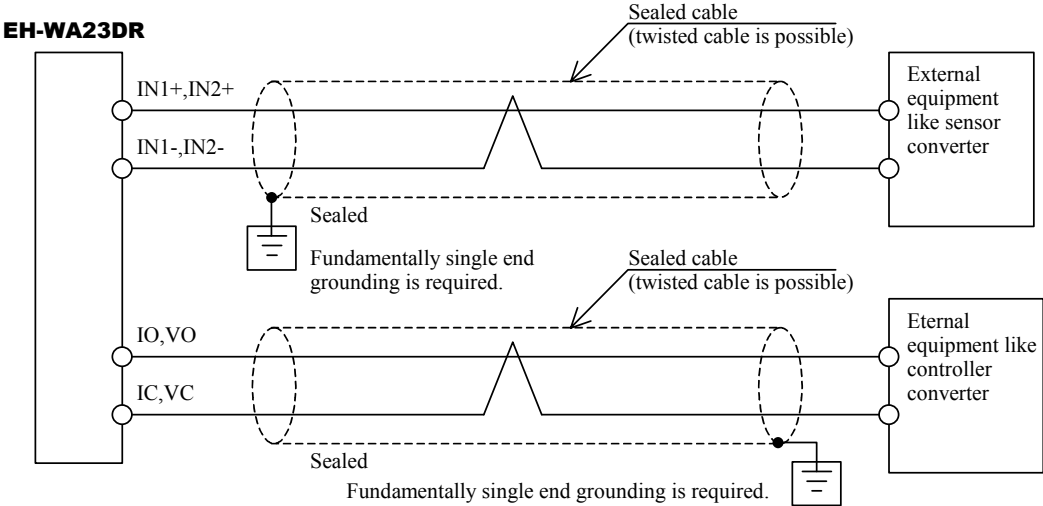

Figure 3.3 Wiring of analog output terminal

### 3.4 Operation Mode Setting Switch

Operation modes can be switched by using the operation mode setting switch ("mode setting switch").

(1) 10 points type

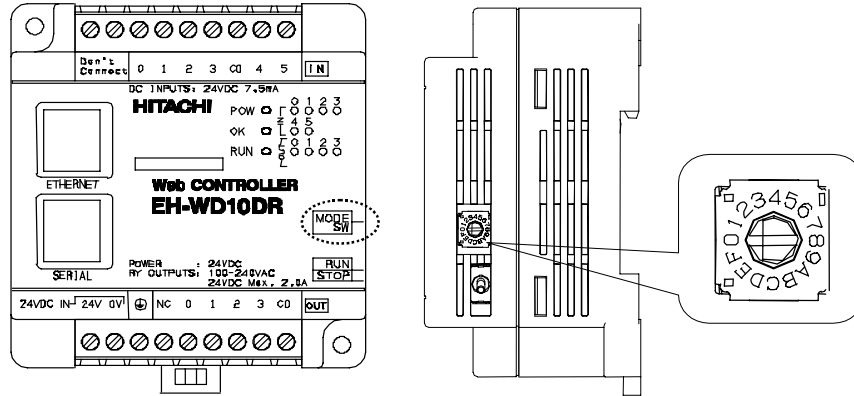

Figure 3.4 Operation Mode Setting Switch (10 points type)

The following table describes settings of the mode setting switch.

Table 3.1 Operation Mode Setting Switch (10 points type)

Switch	Name	Function Description
0	Normal Mode	Set to this mode for normal operation.
1	(Unsettable)	(Do not set.)
2	IP Address Rescue Mode	Set to this mode to reset the IP address to the factory setting address (192.168.0.1).
3~6	(Not in use)	(Do not set.)
7	Initialization to factory setting	Initializes all of Ladder, mwconfig parameters and comments.
8	(Unsettable)	(Do not set.)

**⚠ Caution!!**

To effect the operation mode change, supply the power after changing the switch setting.

(2) 23 potints type

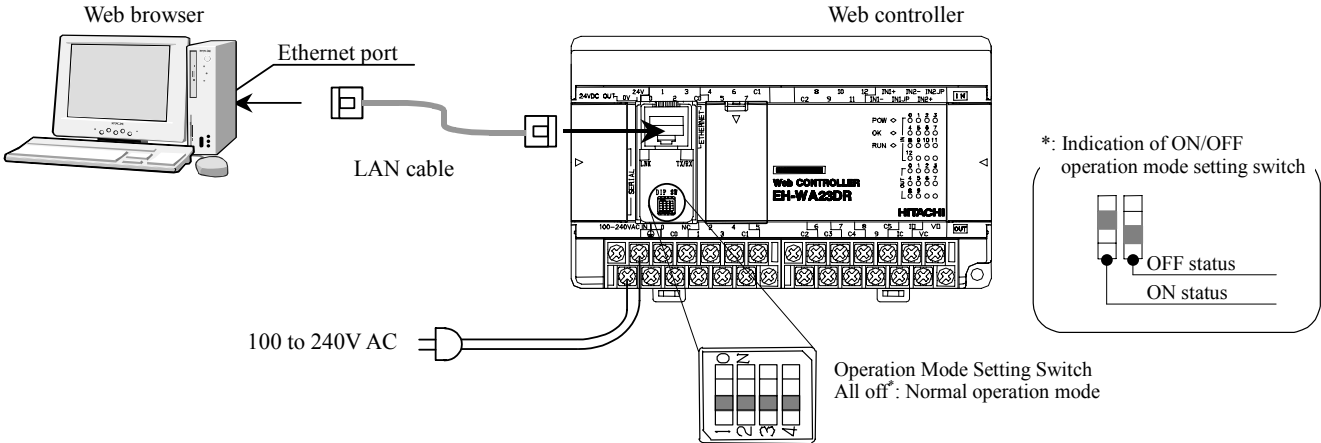

Figure0.1 Operation Mode Setting Switch (23 points type)

The following table describes settings of the mode setting switch.

Table0.1 Operation Mode Setting Switch (23 points type)

DIP switch				Name	Function Description
1	2	3	4		
OFF	OFF	OFF	OFF	Normal Mode	Set to this mode for normal operation.
OFF	OFF	OFF	ON	IP Address Rescue Mode	Set to this mode to reset the IP address to the factory setting address (192.168.0.1).
OFF	OFF	ON	OFF	Initialization to factory setting	Initializes all of Ladder, mwconfig parameters and comments.
ON	OFF	OFF	OFF	Internal termination register ON	Internal termination register (100 OHM) operates. Set this position when serial communication port is used as RS-422/485 only. Don't set this position when serial communication port is used as RS-232C.

**⚠ Caution !!**

To effect the operation mode change, supply the power after changing the switch setting.

### 3.5 Communication Port

#### (1) Ethernet Port

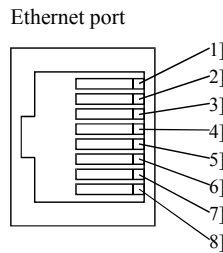
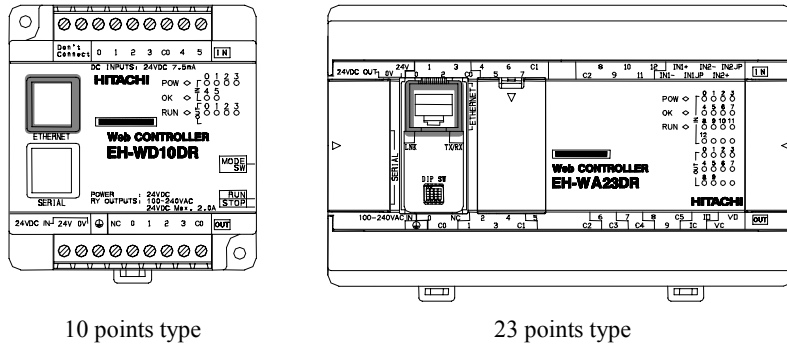

Pin No.	Signal Code	Remarks
1]	TXD +	Sending Data (+)
2]	TXD -	Sending Data (-)
3]	RXD +	Receiving Data (+)
4]		
5]		
6]	RXD -	Receiving Data (-)
7]		
8]		

Figure 3.6 Ethernet Port Pin Numbers and Descriptions

#### (2) Serial Port

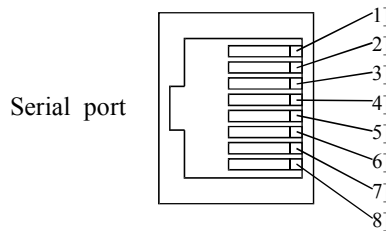
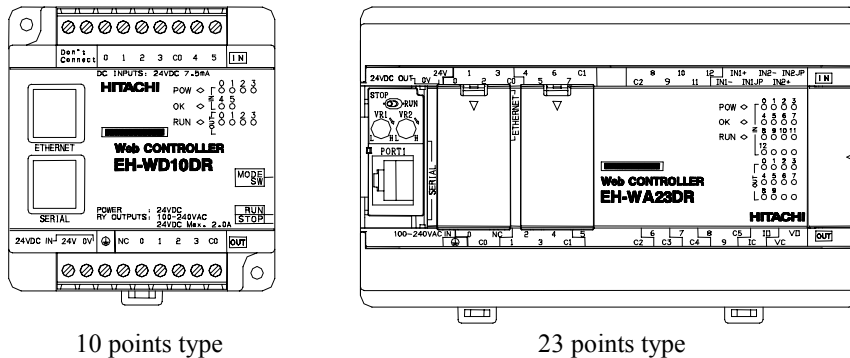

RS-232C

Pin No..	Signal Code	Direction		Meaning
		CPU	Host	
1]	SG			Signal ground
2]	DCD(CD)		←	
3]	DTR(ER)	→		Equipment ready signal
4]	CTS(CS)		←	Enable communication signal
5]	TXD(SD)	→		Send data
6]	RXD(RD)		←	Receive data
7]	DSR(DR)		←	Host connecting signal
8]	RTS(RS)	→		Request to send signal

RS-422/485 (only 23 points type)

Pin No.	Signal Code	Direction		Meaning
		CPU	External equipment	
1]	SG			Signal ground
2]	—			Not use
3]	TX	→		Send data (+)
4]	—			Not use
5]	TXN	→		Send data (-)
6]	RXN		←	Receive data (-)
7]	RX		←	Receive data (+)
8]	—			Not use

Figure 3.7 Serial Port Circuit Diagram and Pin Numbers

# Chapter 4 Preparation

## 4.1 Equipment Preparation

Web Controller (in the factory setting) provides the following functions with the equipment listed in Table 4.1.

- (1) Ethernet task code communication function
- (2) Read/write data in internal output areas via a Web browser

Table 4.1 Required Equipment

Equipment	Specifications	Qty.
Power supply	- 10 points type 24V DC power supply 20W or higher - 23 points type 100 to 240V AC power supply	1
Personal computer ("PC") with a LAN port	Windows 98 or later Internet Explorer ver. 6 or later	1
Programming software for H series	HLW-PC3	1
HUB supporting 10 BASE-T	Compatible with IEEE 802.3	1
LAN cable	Category 5 UTP or STP cable, straight type*1.	1

\*1: Use a straight LAN cable and a HUB when Web Controller is connected to the PC through a HUB.

## 4.2 Network Preparation

### (1) Cable connection

Refer to Figure 4.1 and 4.2, and connect appropriate cable to each equipment.

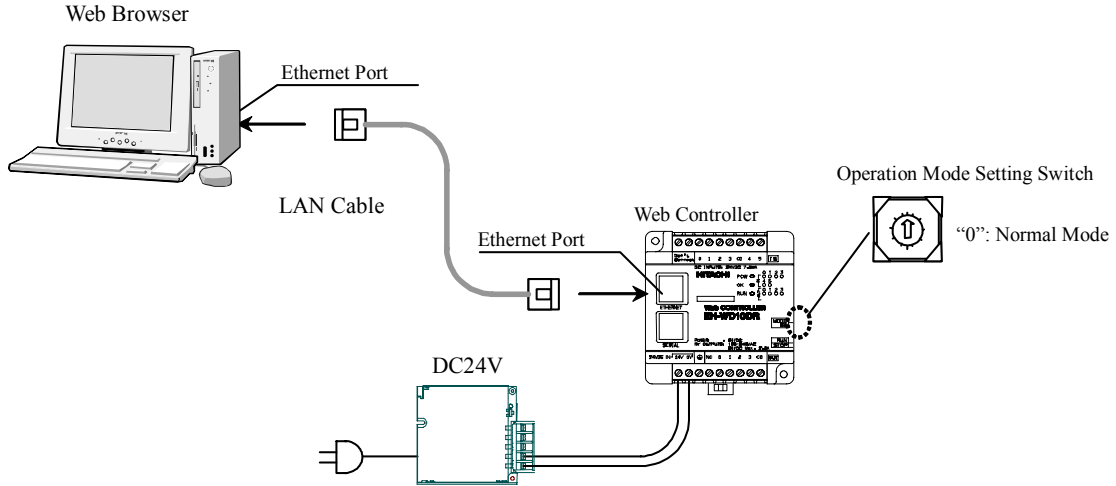
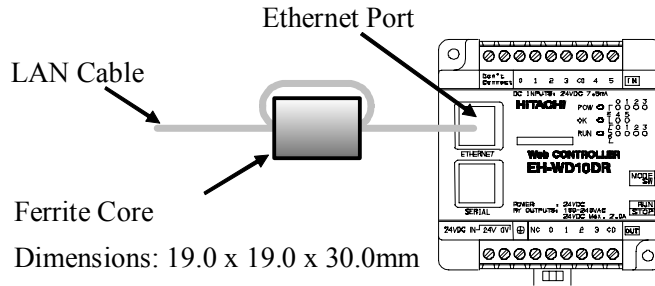

Figure 4.1 Sample Connections (10 points type)

**Caution**

The following procedures are required to have Web Controller complied with the CE Marking (EMC regulations).

- (1) Route the LAN cable through within a metal duct separately from the power cable and I/O signal cable.
- (2) Install the supplied ferrite core around the LAN cable.



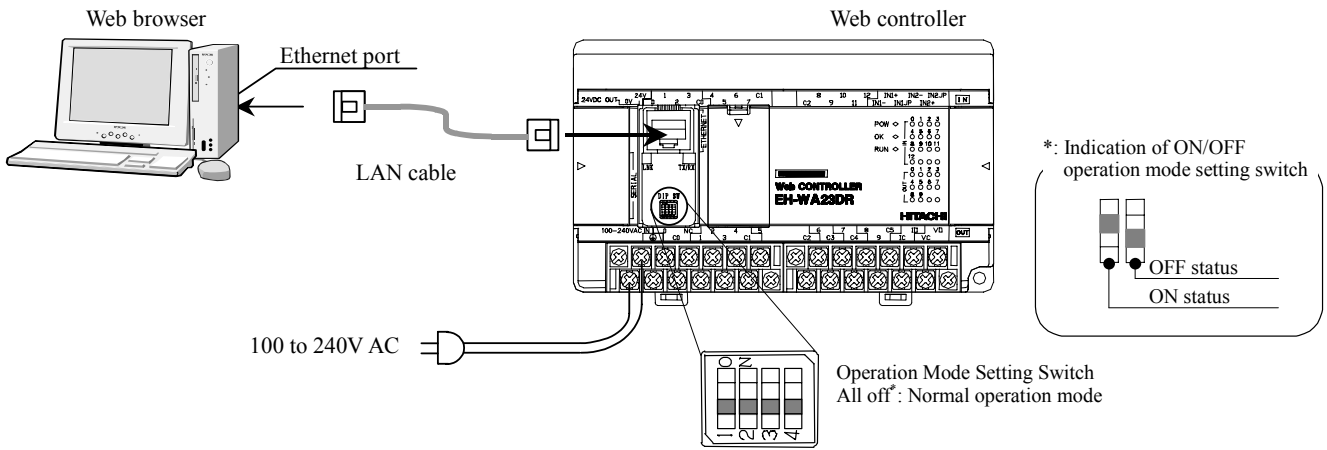

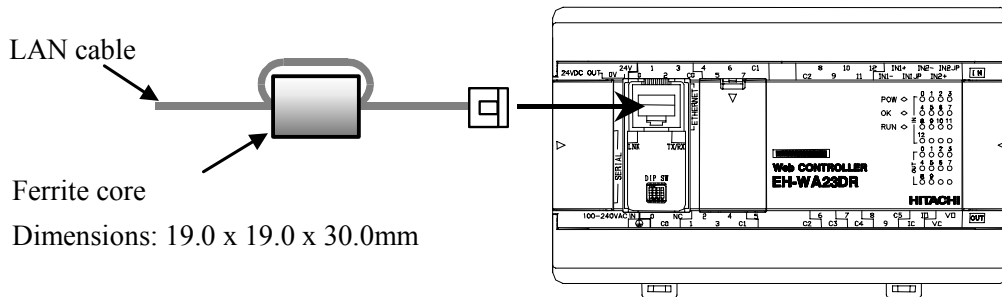

Figure 4.2 Sample Connections (23 points type)

 <b>Caution</b>	<p>The following procedures are required to use Web Controller under noisy condition.</p> <ol style="list-style-type: none"> <li>(1) Route the LAN cable through within a metal duct separately from the power cable and I/O signal cable.</li> <li>(2) Install the supplied ferrite core around the LAN cable.</li> </ol>
--	--





(2) PC network settings

- Follow the steps below to change the PC network settings for the access to Web Controller’s setting pages (for Super User Registration and System configuration).

1. Click the Start menu, and double-click [Settings] > [Network and Dial-up Connections] > [Local Area Connection] to open the window shown in the right. Then click [Properties].

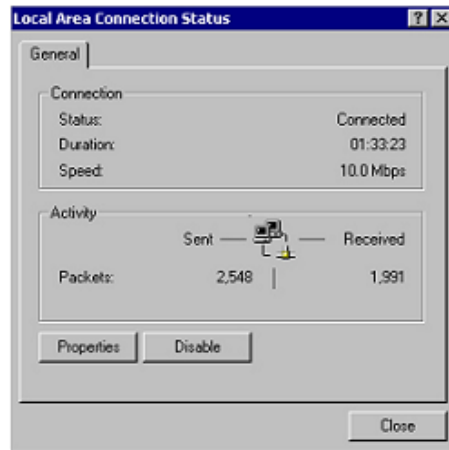

2. Double-click [Internet Protocol (TCP/IP)].

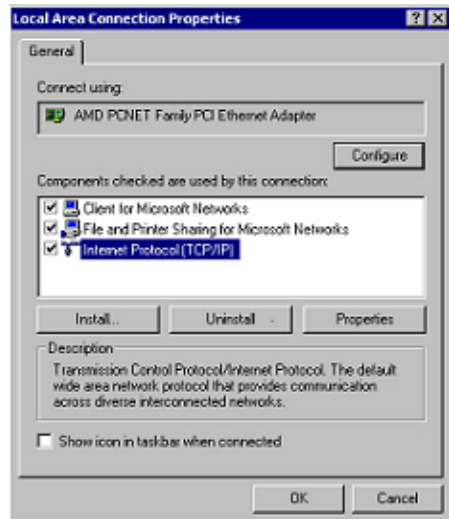

3. Select [Use the following IP address], and enter **an IP address other than 192.168.0.1 and 192.168.0.225** (the example shown in the right uses 192.168.0.15) in the IP address field, and then enter **255.255.255.0** in the Subnet mask field.

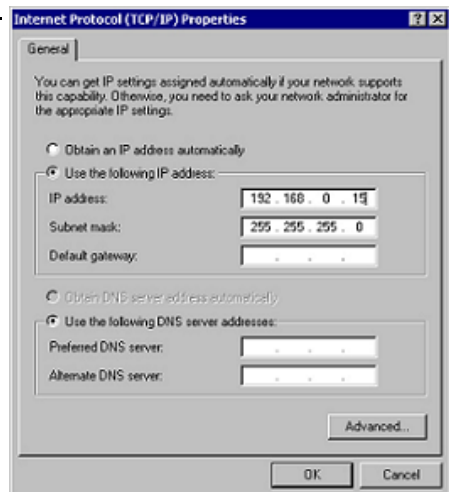

4. Click [OK].

- Supply the power to Web Controller when “Installation and Wiring” and “PC network settings” are completed.  
 - Confirm that the network is properly established.

## 4.3 Network Connection Check

Follow the steps below to confirm the network connection is properly established. The following steps describe procedures for Windows 2000.

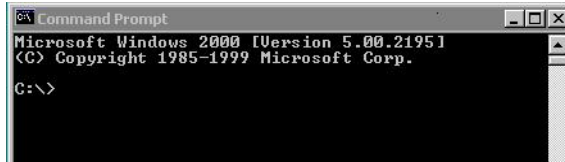

```

Microsoft Windows 2000 [Version 5.00.2195]
(C) Copyright 1985-1999 Microsoft Corp.
C:\>

```

Select [Start] > [Programs] > [Accessories] > [Command Prompt] to open the Command Prompt window.

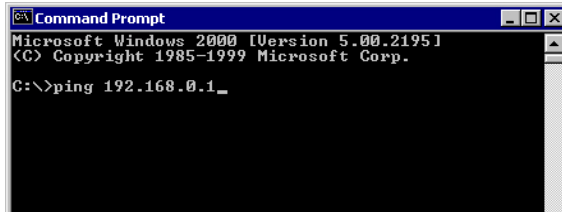

```

Microsoft Windows 2000 [Version 5.00.2195]
(C) Copyright 1985-1999 Microsoft Corp.
C:\>ping 192.168.0.1_

```

Type the following command.

```
ping 192.168.0.1
```

Note:

This command is not case sensitive.

When the computer returns

```
Reply from 192.168.0.1 ...
```

in four consecutive lines<sup>\*1</sup>, then your PC settings are completed.

Go to “4.6 Access to a Web Server.”

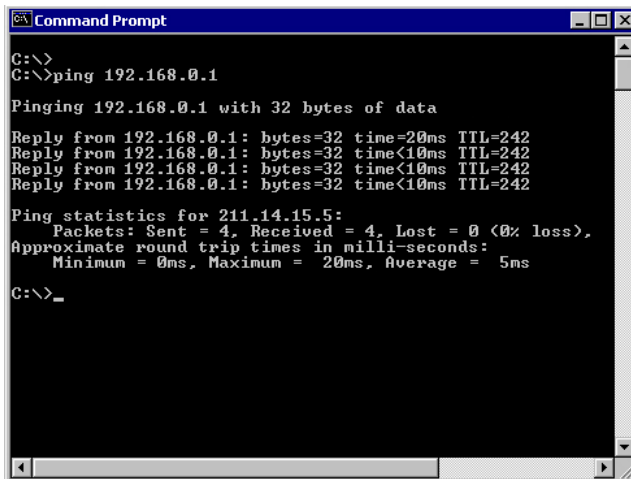

```

Microsoft Windows 2000 [Version 5.00.2195]
(C) Copyright 1985-1999 Microsoft Corp.
C:\>ping 192.168.0.1
Pinging 192.168.0.1 with 32 bytes of data:
Reply from 192.168.0.1: bytes=32 time=20ms TTL=242
Reply from 192.168.0.1: bytes=32 time<10ms TTL=242
Reply from 192.168.0.1: bytes=32 time<10ms TTL=242
Reply from 192.168.0.1: bytes=32 time<10ms TTL=242
Ping statistics for 211.14.15.5:
    Packets: Sent = 4, Received = 4, Lost = 0 (0% loss),
    Approximate round trip times in milli-seconds:
        Minimum = 0ms, Maximum = 20ms, Average = 5ms
C:\>_

```

\*1:

In default, the ping command returns the response for four times. For details of the ping command, type the following command:  
ping/help

If the following response is returned for the ping command, the communication between your PC and EH-WD10DR is not established:

```
Request timed out.
```

Check the following points again.

[Check Points]

- Have the communication settings of Web Controller been changed? (They are not in the factory setting.)
- Are the PC network settings correct?
- Are the network devices operating properly?
- Are appropriate cables used?

## 4.4 On-line Connection of LADDER EDITOR for Windows

For Windows 98 or later

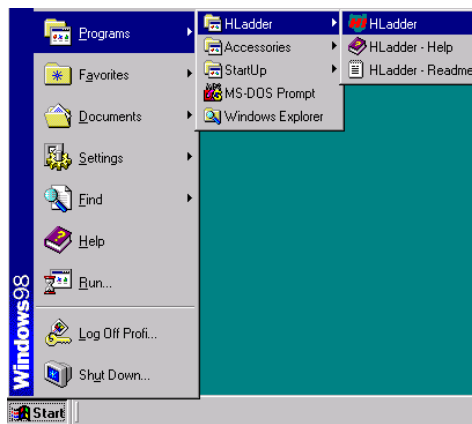

Start the LADDER EDITOR for Windows.

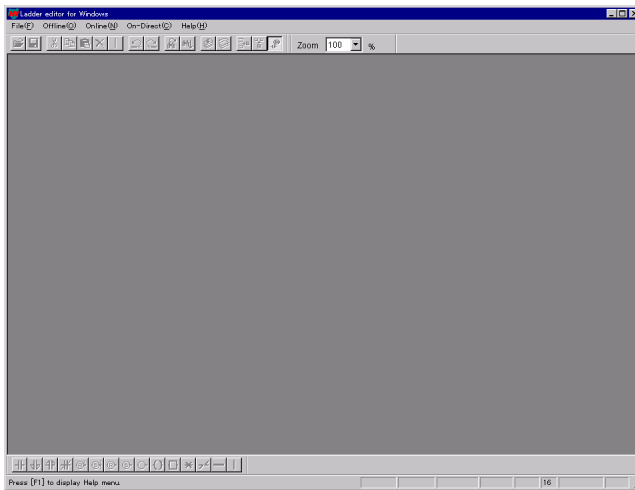

Select [Off-line].

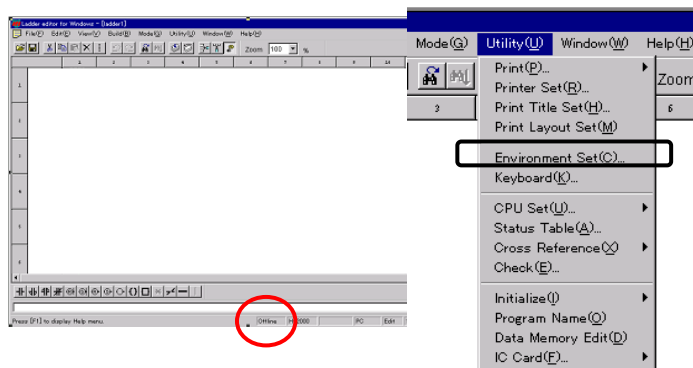

When you are off-line, an indication stating “off-line” appears as shown in the red circle in the left illustration.

Select [Utilities] > [Environment set].

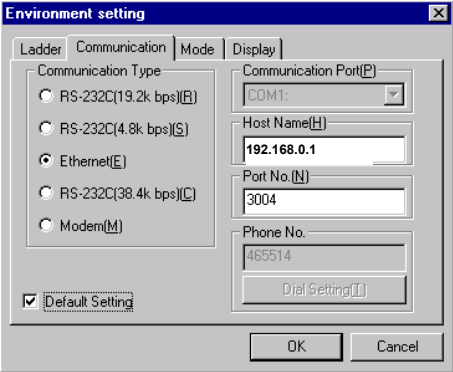

Select the [Communication] tab, enter “192.168.0.1” in [Host Name] and “3004” in [Port No.], and then click the [OK] button.

Select [File] > [GRS] to return to the GRS screen.

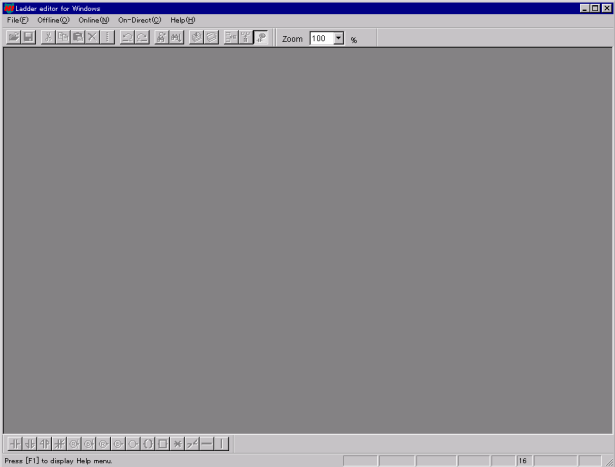

Select [On-line].

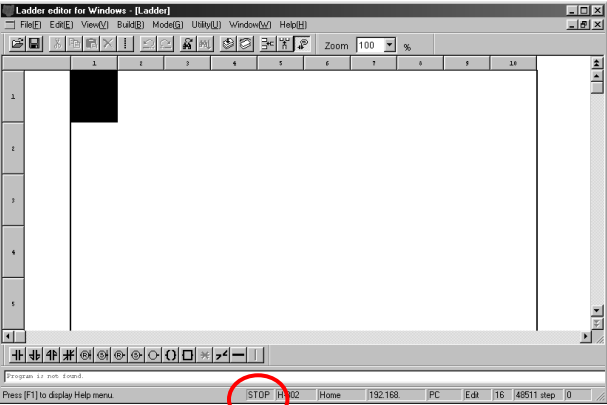

When you are on-line, an indication stating the operation condition of EH-WD10DR (RUN or STOP) appears as shown in the red circle in the left illustration.

Please refer to the “Hitach Programmable Controller, Personal Computer Software: LADDER EDITOR for Windows (NJI-206\*)” for further operation procedures of LADDER EDITOR for Windows.

**⚠ Caution!!**

If two PCs connected to Web Controller use the same port number for the connection with the LADDER EDITOR for Windows, the LADDER EDITOR for Windows on the PC connected first stays on-line, but the latter PC can not communicate with the LADDER EDITOR for Windows. Make sure that different port numbers are used for LADDER EDITOR For Windows connections.

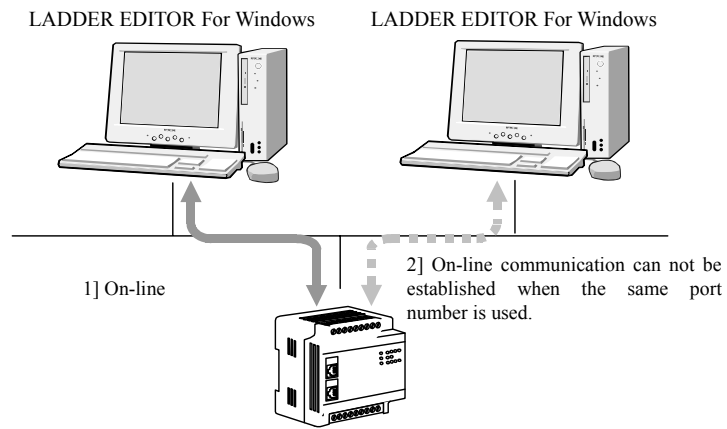

Figure 4.3 When the same port number is used for LADDER EDITOR for Windows connections.

# Chapter 5 Access to Web pages

## 5.1 Web server Function

Web Controller is equipped with HTTPD (Hyper Text Transfer Protocol Daemon) which enables users monitoring and setting of the data in the unit, and dedicated CGI (Common gateway Interface) for a Web server function.

(1) Equipment composition and access procedures

Outline of procedures to access Web pages are described in the following flow chart:

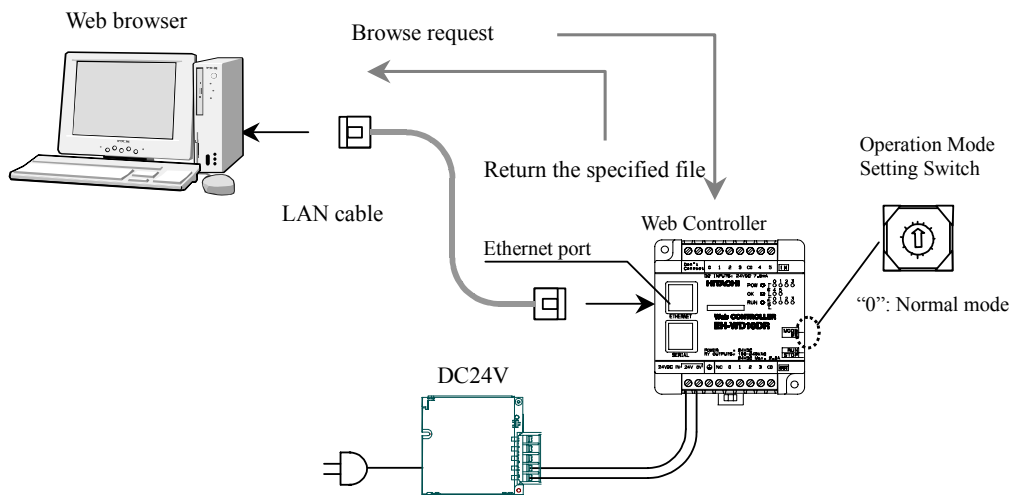
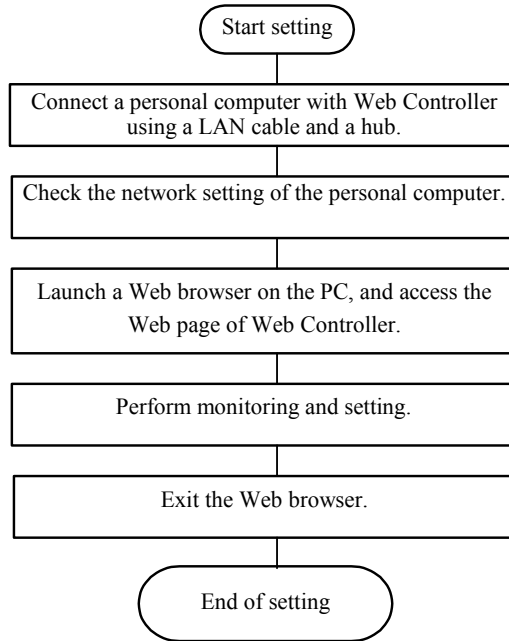

Figure 5.1 Outline of access procedures

(2) Network setting on a PC

To access the Web contents in Web Controller using the network composition described in Figure 5.1, the network setting on a PC should meet the following requirements.

Condition 1	Subnet mask should be “255.255.255.0.”
Condition 2	The first three bytes of the IP address should be “192.168.0” and the last byte does not overlap with the last byte *1 of the IP address of the Web controller.

\*1: The factory setting of the IP address of Web Controller is “192.168.0.1.”

If the subnet mask of the PC is “255.255.255.0” and the IP address is “192.168.0.128,” you do not have to change the network setting on the PC.

If the subnet mask of the PC is “255.255.255.0” and the IP address is “172.16.0.128,” you have to change the network setting on the PC.

How to change the network setting on a PC is described below. It is assumed that the operating system is Windows 98 or later.

How to change the IP address

(1) Open [Network] from [Control Panel].

Select [TCP/IP] protocol, and click the [Property] button.

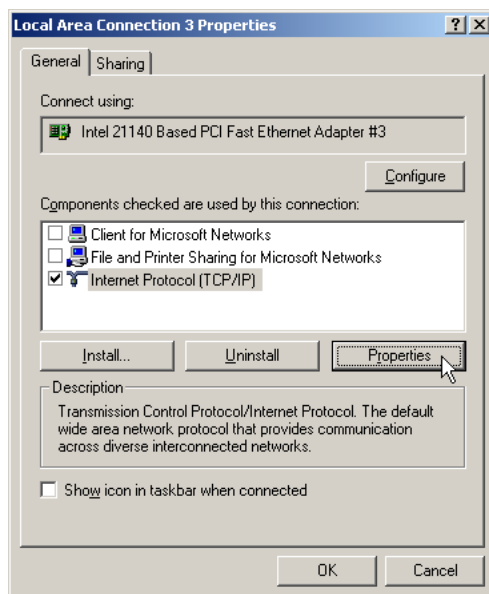

(2) Select the [IP address] tag, and set to “192.168.0.128.”

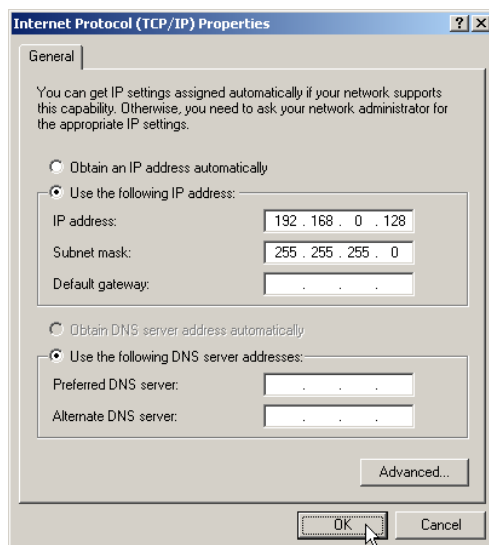

(3) Clicking the [OK] button prompts you for the restart. Restart the PC when ready.

## 5.2 Access to Web pages

To browse the Web pages in Web Controller, enter the URL in the address bar of the Web browser according to the following format:

Table 5.1 An example of the URL statement to access Web servers

	URL statement	Remarks
1	<p>http://192.168.0.1/browse.cgi?□□□□.htm</p> <p>└──────────┬──────────┬──────────┬──────────┘            IP address Program for browsing Requested file name</p>	Use this statement to access all files stored in Web Controller including HTML files.

Connection requests from a Web browser are constantly accepted, if Web Controller is turned on when the Operation Mode Setting Switch is in “Normal Mode.”

To access Web pages, enter the IP address, browsing CGI and the requested file name in the address bar of the Web browser after launching a Web browser.

### ⚠ Caution!!

The factory setting of the IP address of Web Controller is “192.168.0.1.” If the IP address has been changed in “System Configuration,” you should enter the IP address after the change.

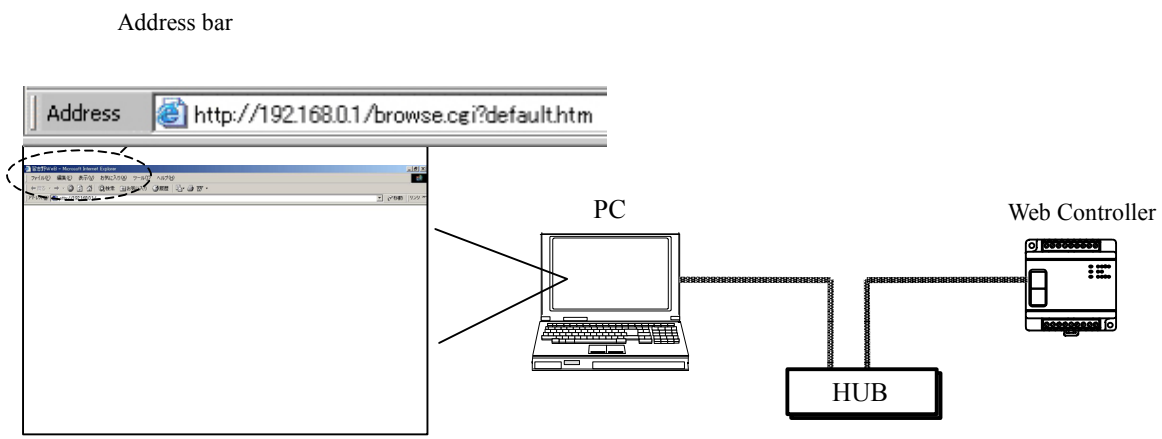

Figure 5.2 Access to Web pages

### ⚠ Caution!!

If Web pages are not displayed after performing the procedures described in this section, it may possible that the “proxy setting” of the Web browser is enabled.

Follow the steps below not to specify the proxy server. The following steps describes procedures for Windows 2000.



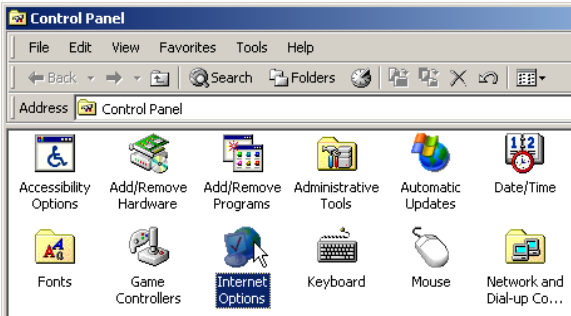

Open [Internet option] from [Control Panel].

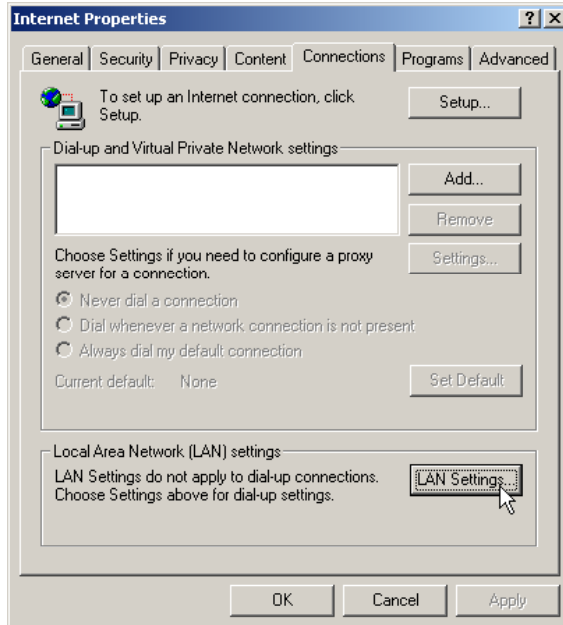

Select [Connection] tab, and click the [Configuration of LAN] button.

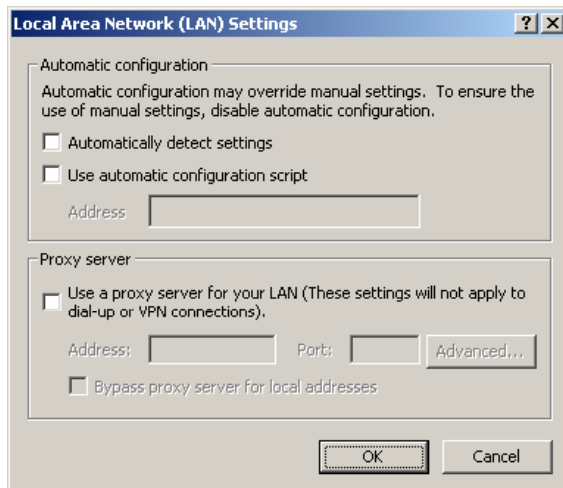

Confirm no specified proxy server.

## 5.3 Access to default Web pages

This section describes how to access the default Web page stored in Web Controller as a factory setting. The following three HTML files are stored in Web Controller as a factory setting.

- \* default.htm
- \* comments.htm
- \* d\_mobile.htm

(1) 10 points type

### default.htm

Launch a Web browser and enter the following URL in the address bar to access Web pages.

Table 5.2 An example of the URL statement to access Web servers

	URL statement	Remarks
1	<p>http://192.168.0.1/browse.cgi?default.htm</p> <p style="margin-left: 100px;">└── IP address</p>	The IP address described here is the factory setting. If the change has been made, please enter the IP address after the change.

Following screens will be displayed. (These screens are displayed in two screens, because they are too long to fit in one.)

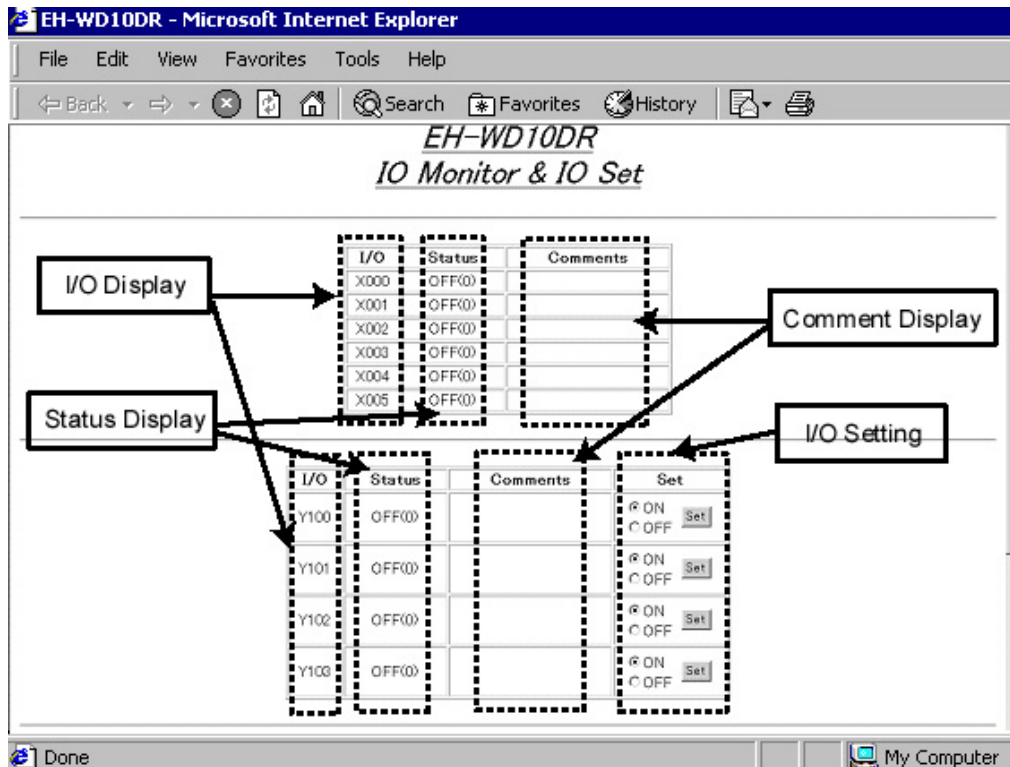

Figure 5.3 default.htm

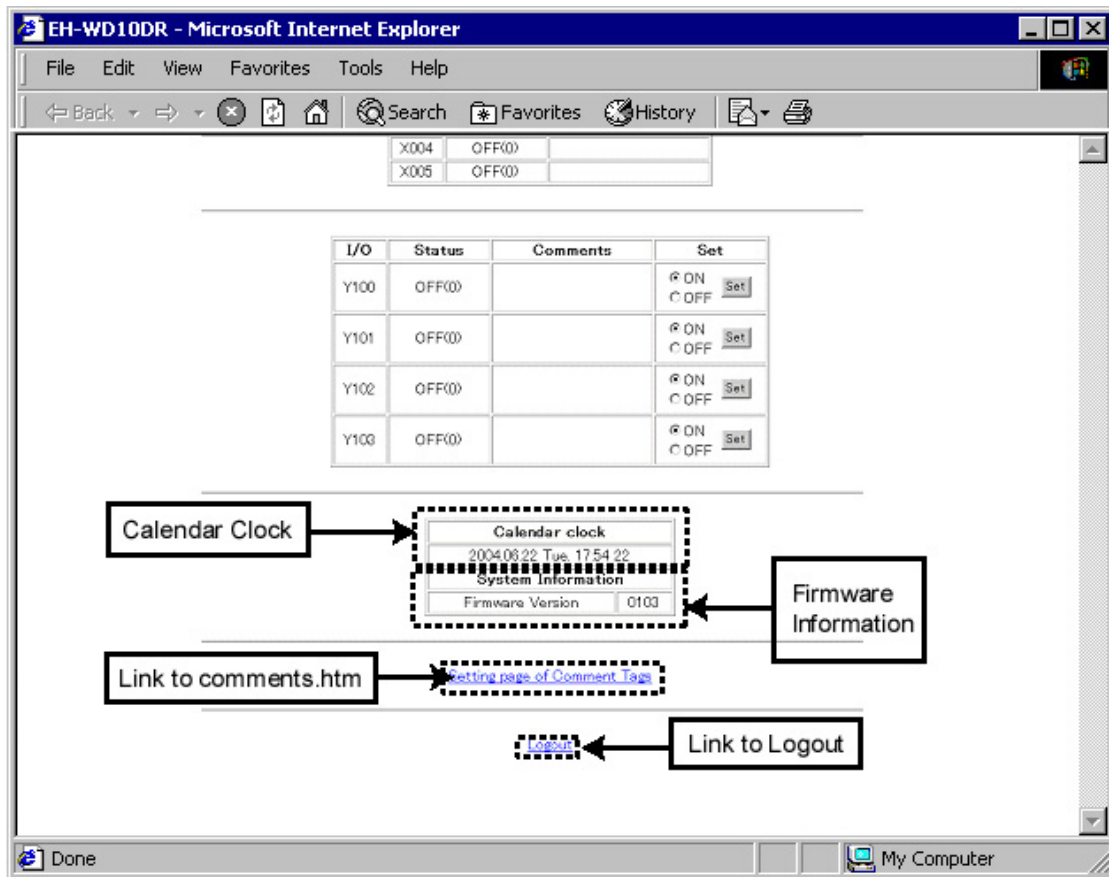

Figure 5.4 default.htm

Table 5.3 Contents of “default.htm”

	Name	Contents
1	I/O Display Column	Indicates I/O. It is described in the HTML file.
2	Status Display Column	Displays the current status of the external input/output (X000 - X005, Y100 - Y103) in ON (1) or OFF (0).
3	Comment Display Column	Displays the comment set in “comments.htm.”
4	I/O Set Part	Sets ON or OFF to the external output.
5	Calendar Clock Column	Displays the current calendar time of Web Controller.
6	Firmware Information Column	Displays the current firmware version.
7	Link to “comments.htm”	Accesses “comments.htm” stored in Web Controller.
8	Link to Logout	Logs out from the Web page. (No login operation is necessary, because no access authorizations are set to “default.htm” as a factory setting. Therefore, there is no logout operation. Please refer to “Chapter 6 - What users can do with a Web browser” for details. Or set an access authorization in “System Configuration,” and access “default.htm” again.

comments.htm

The following screen is displayed after accessing “comments.htm.”

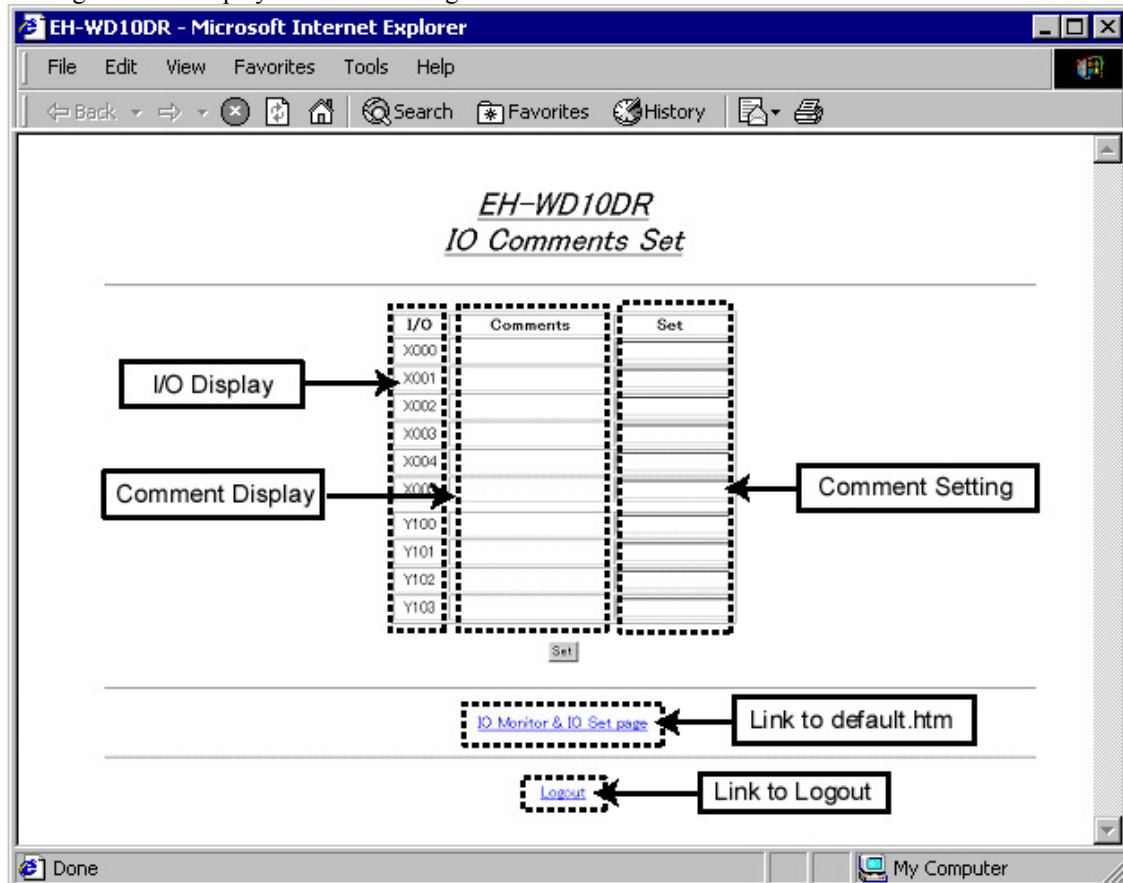

Figure 5.5 comments.htm

Table 5.4 Contents of “default.htm”

	Name	Contents
1	I/O Display Column	Indicates I/O. It is described in the HTML file.
2	Comments Display Column	Displays the comment set in the Comment Setting Column.
3	Comments Set Column	Enabled by entering a comment and click the [Set] button. Enter a half-width space and click the [Set] button to delete the comment you set.
4	Link to default.htm	Accesses “default.htm” stored in Web Controller.
5	Link to Logout	Logs out from the Web page. (No login operation is necessary, because no access authorizations are set to “comments.htm” as a factory setting. Therefore, there is no logout operation. Please refer to “Chapter 6 - What users can do with a Web browser” for details. Or set an access authorization in “System Configuration,” and access “comments.htm” again.

d\_mobile.htm

The following screen is displayed after accessing “d\_mobile.htm.”

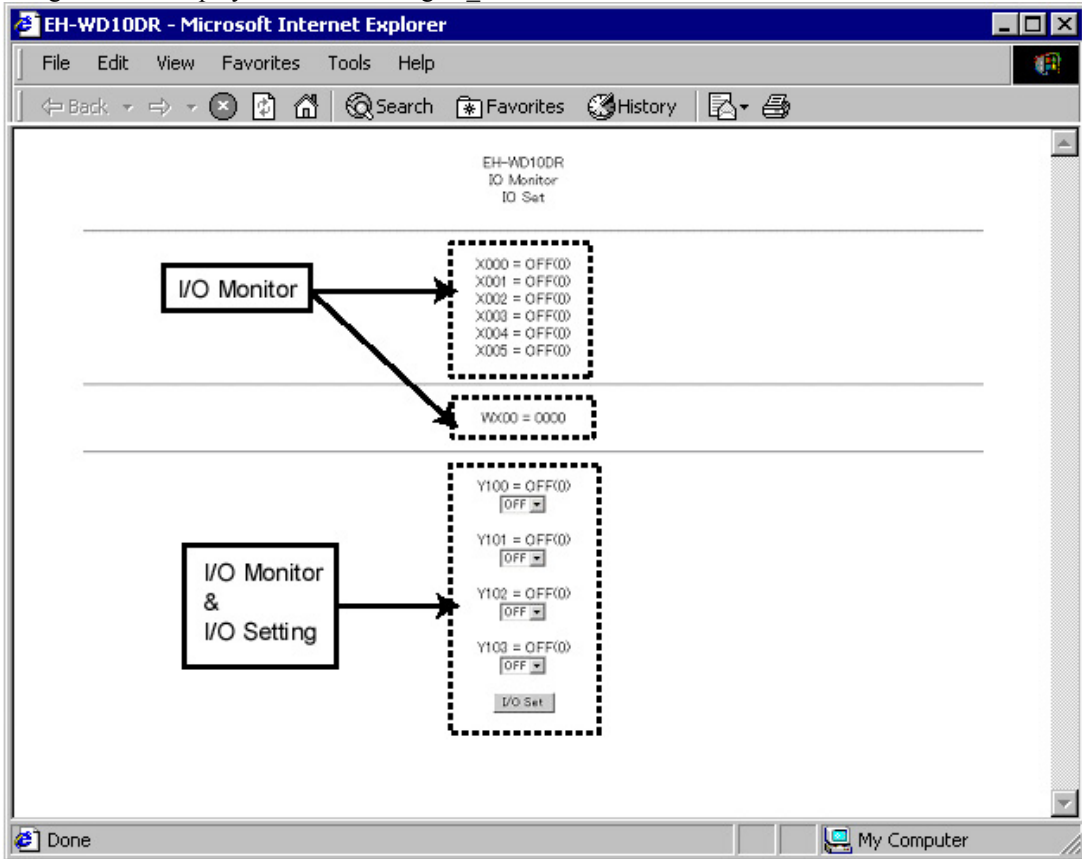

Figure 5.6d\_mobile.htm

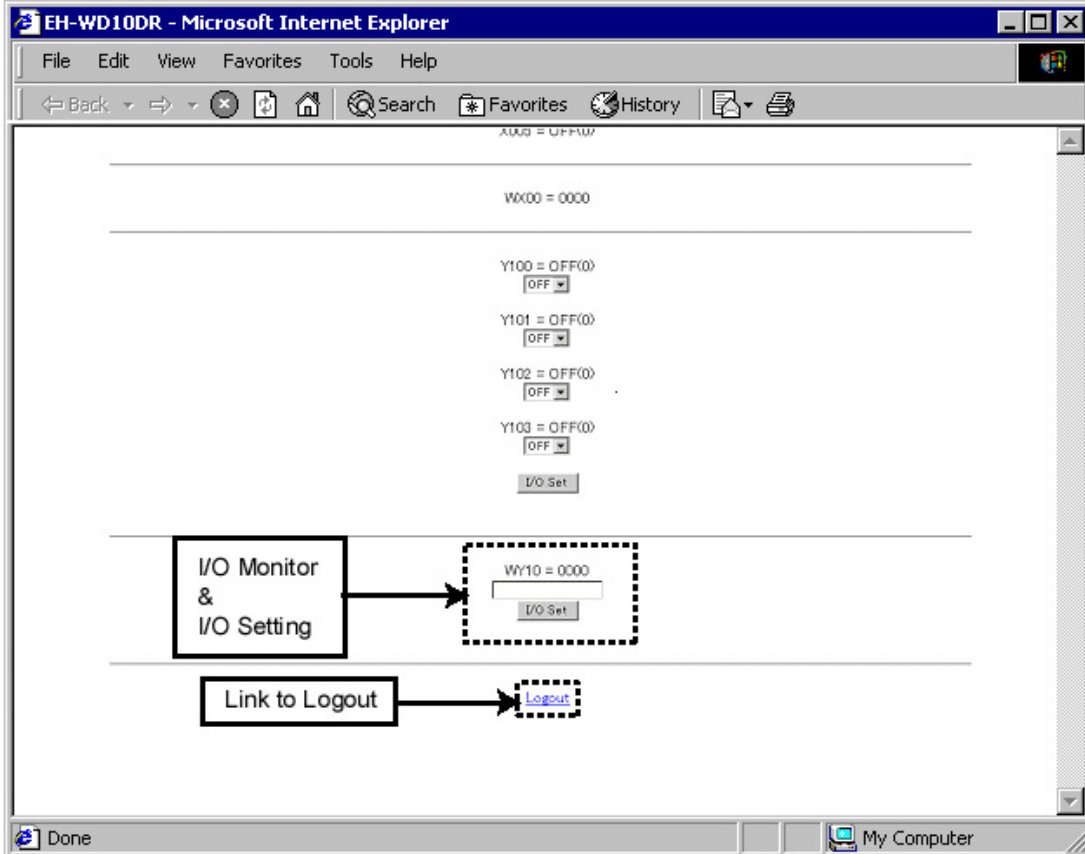

Figure 5.7d\_mobile.htm

Table 5.5 Contents of "d\_mobile.htm"

	Name	Contents
1	I/O Monitor Column	Displays the current status of the external output (X000 - X005 and WX00) in ON (1) or OFF (0) if it is a bit data, or in a hexadecimal digit if it is a word data.
2	I/O Monitor & I/O Set Column	Displays the current status of the external output (Y100 - Y103 and WY10) in ON (1) or OFF (0) if it is a bit data, or in a hexadecimal digit if it is a word data. Click the [I/O Set] button either after selecting "ON" or "OFF" on a pulldown menu or entering a value in the textbox in a hexadecimal digit, the value is set to Web Controller.
3	Link to Logout	Logs out from the Web page.  (No login operation is necessary, because no access authorizations are set to "d_mobile.htm" as a factory setting. Therefore, there is no logout operation. Please refer to "Chapter 6 - What users can do with a Web browser" for details. Or set an access authorization in "System Configuration," and access "d_mobile.htm" again.

(2) 23 points type

### default.htm

Launch a Web browser and enter the following URL in the address bar to access Web pages.

Table 5.6 An example of the URL statement to access Web servers

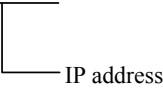
	URL statement	Remarks
1	<p style="text-align: center;">http://192.168.0.1/browse.cgi?default.htm</p> <div style="margin-left: 100px;">  <p style="margin-left: 100px;">IP address</p> </div>	The IP address described here is the factory setting. If the change has been made, please enter the IP address after the change.

Following screens will be displayed.

The screenshot shows the 'EH-WA23DR IO Monitor & IO Set' web interface. It features several data tables and control elements:

- DI Table:** A table with columns 'I/O', 'Status', and 'Comments'. It lists digital inputs X000 through X012, all with a status of 'OFF(0)'.
- AI Table:** A table with columns 'I/O', 'HEX', 'BIN', and 'Comments'. It lists analog inputs WXX0 through WXX31. WXX0 has a HEX value of 0000 and a BIN value of 0000000000000000. WXX30 has a HEX value of 0001 and a DEC (Unsigned) value of 1. WXX31 has a HEX value of 0000 and a DEC (Unsigned) value of 0.
- DO Table:** A table with columns 'I/O', 'Status', 'Comments', and 'Set'. It lists digital outputs Y100 through Y109, all with a status of 'OFF(0)'. Each row includes radio buttons for 'ON' and 'OFF' and a 'Set' button.
- AO Table:** A table with columns 'I/O', 'HEX', 'BIN', 'Comments', and 'Set (HEX)'. It lists analog outputs WY10 through WY40. WY10 has a HEX value of 0000 and a BIN value of 0000000000000000. WY40 has a HEX value of 0000 and a DEC (Unsigned) value of 0. Each row includes a 'Set' button.
- Calendar clock:** Displays the date '2000.01.10 Mon. 06:29:24' and system information including 'Firmware Version 0102'.
- Links:** Includes a 'Link to comments.htm' pointing to 'Setting page of Comment Tags', and a 'Link to Logout' pointing to a 'Logout' button.

Annotations with arrows point to various parts of the interface:

- I/O Display:** Points to the DI and AI tables.
- Status Display:** Points to the Status column of the DI and DO tables.
- Comment Display:** Points to the Comments column of the DI, AI, and DO tables.
- IO Setting:** Points to the 'Set' buttons in the DO and AO tables.

Figure 5.8 default.htm

Table 5.7 Contents of "default.htm"

	Name	Contents
1	I/O Display Column	Indicates I/O. It is described in the HTML file.
2	Status Display Column	Displays the current status of the external input/output (X000 - X012, WX0, WX30 to WX31, Y100 - Y109, WY10, WY40). - ON (1) or OFF (0) - HEX (decimal display) - BIN (binary display) - DEC (unsigned) (decimal display without sign)
3	Comment Display Column	Displays the comment set in "comments.htm".
4	I/O Set Part	Sets ON or OFF and values to the external output. Sets Hexadecimal value when HEX and unsigned decimal value when unsigned DEC.
5	Calendar Clock Column	Display the current calendar time of Web Controller.
6	Firmware Information Column	Display the current firmware version.
7	Link to "comments.htm"	Accesses "comments.htm" stored in Web Controller.
8	Link to Logout	Logs out from the Web Controller. (No login operation is necessary, because no access authorizations are set to "default.htm" as factory setting. Therefore, there is no logout operation. Please refer to "Chapter 6 – What users can do with a Web browser" for details. Or set an access authorization in "System Configuration", and access "default.htm" again.)



comments.htm

The following screen is displayed after accessing “comments.htm”.

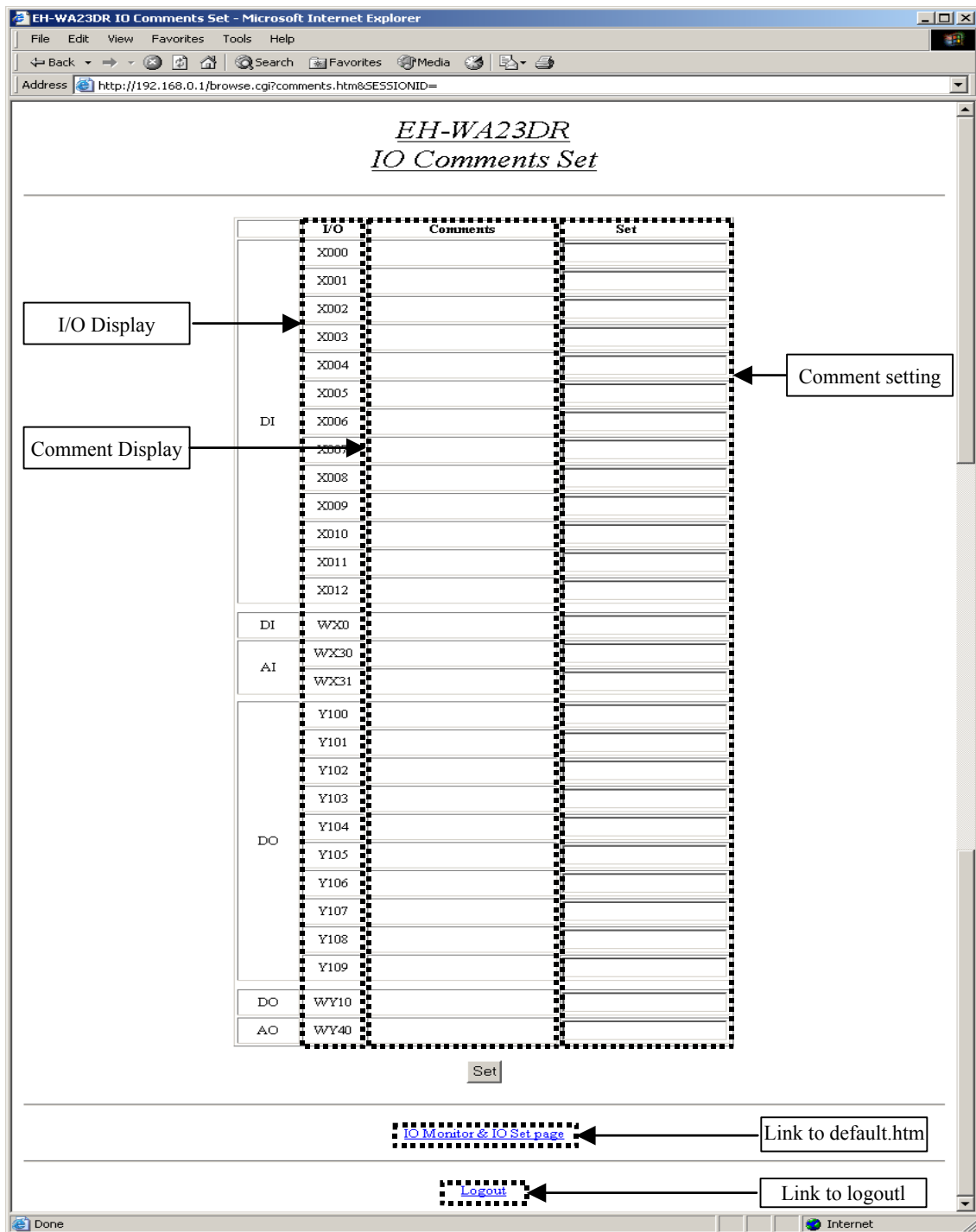

Figure 5.9 comments.htm

Table 5.8 Contents of “comments.htm”

	Name	Contents
1	I/O Display	Indicates I/O. It is described in the HTML file.
2	Comments Display Column	Displays the comment set in the Comment Setting Column.
3	Comments Setting Column	Enable by entering a comment and clicking the [Set] button. <b><u>Enter a half-width space and click the [Set] button to delete the comment you set.</u></b>
4	Link to default.htm	Accesses to “default.htm” stored in Web Controller.
5	Link to Logout	Logs out from the Web page. (No login operation is necessary, because no access authorizations are set to “comments.htm” as a factory setting. Therefore, there is no logout operation. Please refer to “Chapter 6 – What user can do with a Web browser” for details. Or set an access authorization in “System Configuration”, and access “comments.htm” again.

d\_mobile.htm

The following screen is displayed after accessing “d\_mobile.htm”.

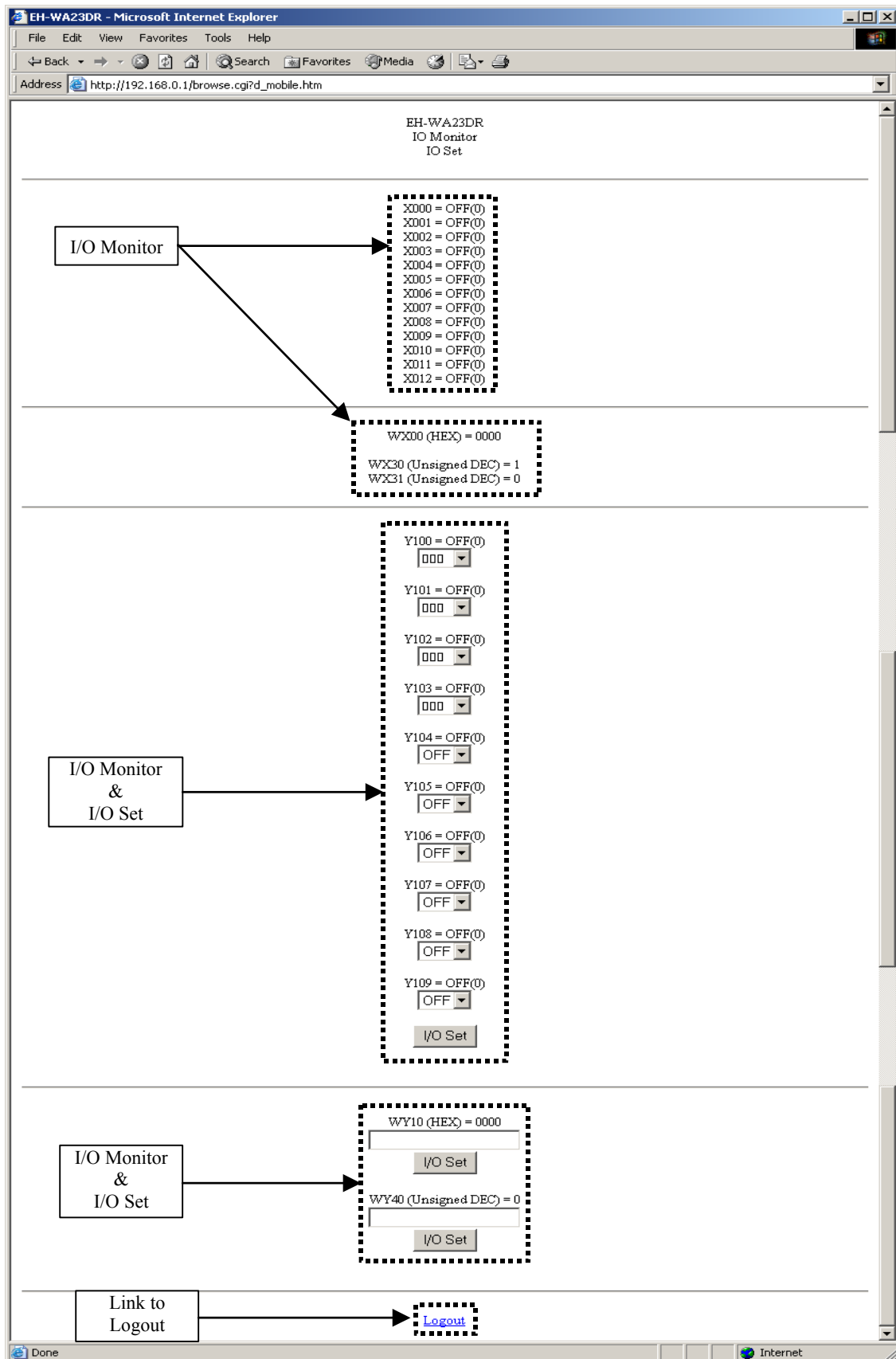

Figure 5.10 d\_mobile.htm

Table 5.9 Contents of “d\_mobile.htm”

	Name	Contents
1	I/O Monitor Column	Displays the current status of the external input (X000 - X012, WX00, WX30 - WX31). - ON(1) or OFF(0) - HEX (Hexadecimal display) - Unsigned DEC (Decimal display without sign)
2	I/O Monitor & I/O Set Column	Displays the current status of the external input (Y100 - Y109, WY10, WY40). - ON(1) or OFF(0) - HEX (Hexadecimal display) - Unsigned DEC (Decimal display without sign) Click the [I/O Set] button either after selecting “ON” or “OFF” on a pull down menu or entering a value in the textbox (HEX is hexadecimal, Unsigned DEC is decimal without sign), the value is set to Web Controller.
3	Link to Logout	Logs out from the Web page. (No login operation is necessary, because no access authorizations are set to “d_mobile.htm” as a factory setting. Therefore, there is no logout operation. Please refer to “Chapter 6 – What users can do with a Web browser” for details. Or set an access authorization in “System Configuration”, and access “d_mobile.htm” again.)

***MEMO***

# Chapter 6 What users can do with a Web browser

Via a Web browser, it is possible to configure Web Controller as well as monitor or set values on the data memory. This section describes each of these functions. Refer to Chapter 15 and later for actual setting procedures.

## 6.1 Super User Registration

Super Users, who is authorized to configure Web Controller, should be registered. It is possible to register four Super Users, and the privileges which are set by each Super User can be separately defined.

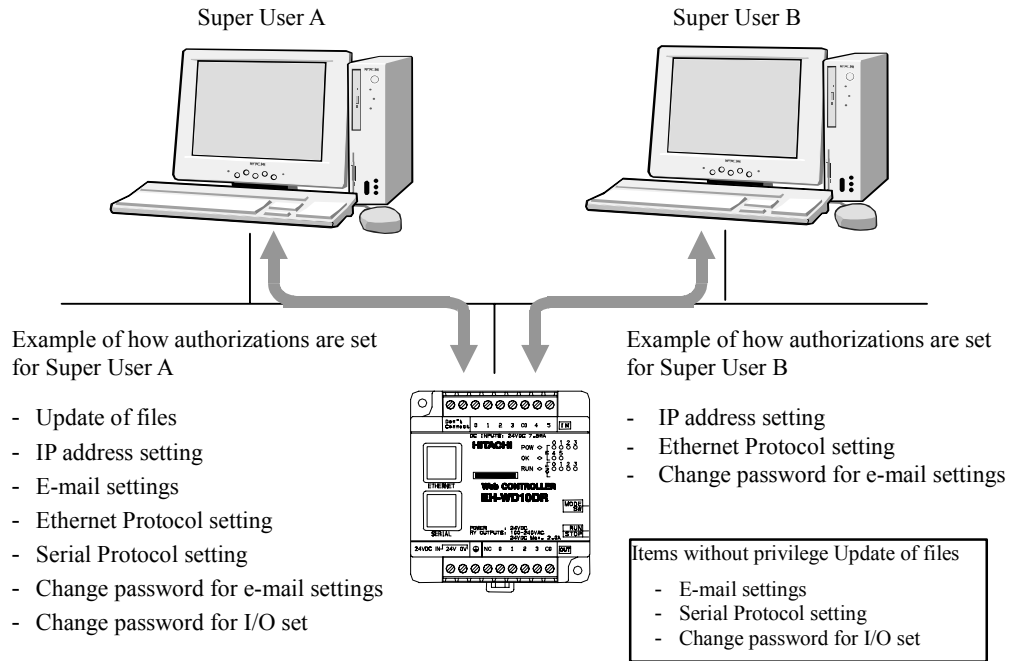

Figure 6.1 Sample setting of privileges for each Super User (10 points type)

Access the following address to register Super Users. Refer to “Chapter 12 Super User Registration” for details.

Table 6.1 An example of URL statement to access the Super User Registration CGI

	URL statement	Remarks
1	<p><a href="http://192.168.0.1/systemsetting.cgi">http://192.168.0.1/systemsetting.cgi</a></p> <p>— IP address</p> <p>— Super User Registration CGI</p>	When accessing to Super User Registration CGI with the factory default IP address.

## 6.2 System Configuration

System Configuration is used for various settings of Web Controller. This function allows you to make network settings (e.g. file registration/deletion and IP address), and to set up e-mail, communication using Ethernet/RS-232C protocols, and ID/Password, as well as to make password change for e-mail address book editing and for I/O settings. Super Users can set limited items depending on their respective registrations.

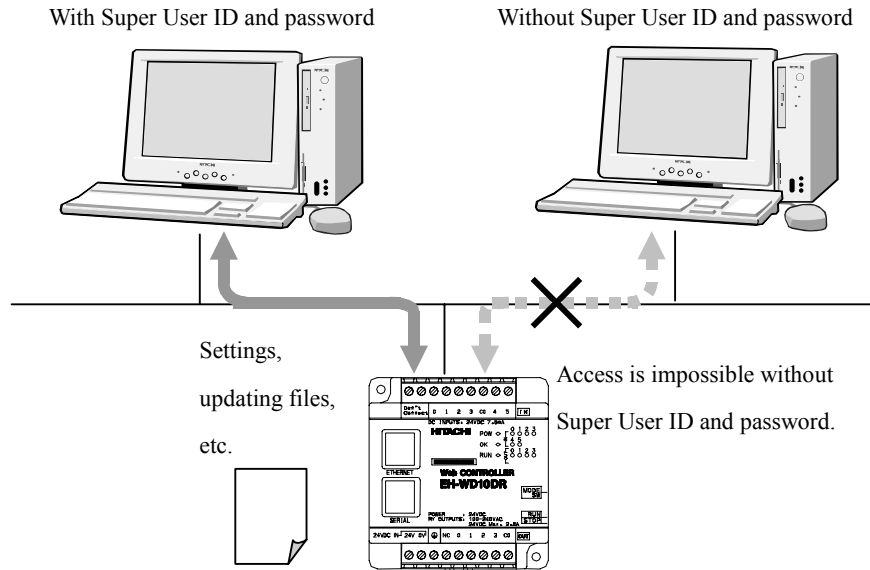

Figure 6.2 Sample setting in “System Configuration”

Access the following address to set the System Configuration. When you access the address and log in to this function, the browser displays the System Configuration index page where you can start various settings. Refer to “Chapter 13 System Configuration” for details.

Table 6.2 An example of URL statement to access System Configuration CGI

	URL statement	Remarks
1	<p>http://<u>192.168.0.1</u>/<u>mwconfig.cgi</u></p> <p style="margin-left: 40px;">└── IP address</p> <p style="margin-left: 100px;">└── System Configuration CGI</p>	<p>When accessing to System Configuration CGI with the factory default IP address.</p>

## (1) Registering, deleting and downloading of files

You can register and delete files in Web Controller, and download files to the local disc.

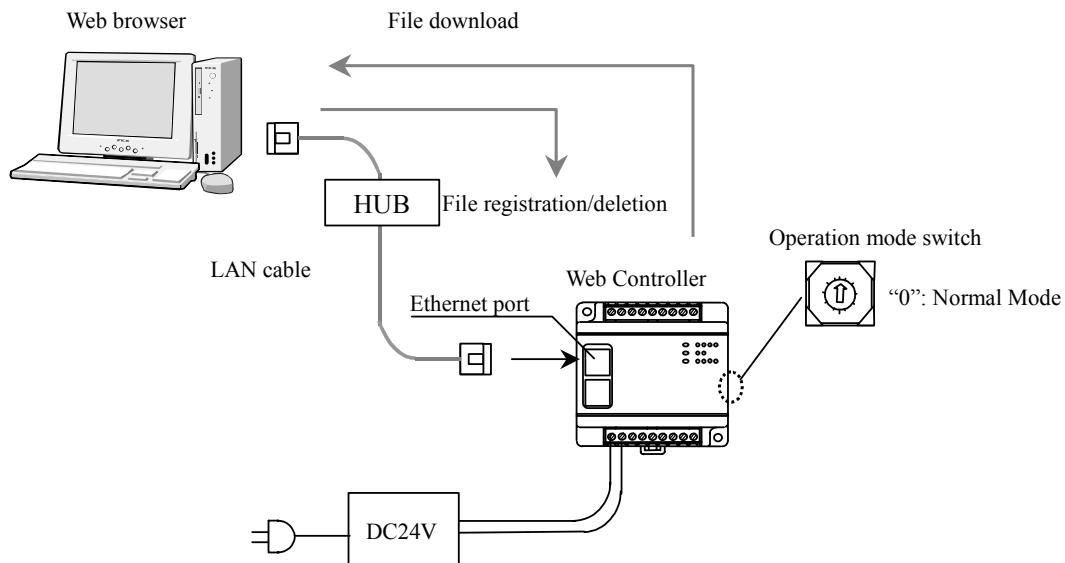

Figure 6.3 Registering, deleting and downloading of files

Three files (“default.htm”, “comments.htm” and “d\_mobile.htm”) are registered as a factory setting. HTML files described by using HTML tag and script can be registered into Web Controller as user Web display structures.

Web Controller supports tags according to the Microsoft Internet Explorer 6.0 (this after IE). There are some difference between 10 points and 23 points unit for files style of HTML and described in following table.

Table 6.3 File registration specifications

	Item	10 points type	23 points type
1	Storable file types	HTML(*.htm)、JPEG(*.jpg)、GIF(*.gif)	HTML(*.htm, <b>.html</b> ), <b>Cascading StyleSheet(.css)</b> , JavaScript(*.js), JPEG(*.jpg, <b>.jpeg, .jpe</b> ), <b>GIF(.gif)</b> , <b>BMP(.gmp)</b> , WAV(*.wav, <b>.wave</b> ), <b>Java Applet(.class)</b> , Shockwave Flash(*.swf)
2	File names	1] Number of characters 1 to 8 one byte characters + extension; 4 characters (.htm, .jpg, .gif) 2] Possible usage character ”A to Z”, “a to z”, “0 to 9”, “-“, “_” 3] It is not allow to store same name of file.	1] Number of characters UP to 15 characters including extension. 2] Possible usage character “A to Z”, “a to z”, “0 to 9”, “-“, “_” 3] It is not allow to store same name of file.
3	Storable file size and number of files	16,380 byte: 8 file (No.1 to 8) 8,188 byte: 16 file (No.9 to 24) 4,092 byte: 16 file (No.25 to 40)	64k byte sector x 5 (Total size is 320k bytes) It is possible to separate 64k bytes sector into some size with 1k byte unit by user’s definition. Therefore, maximum number of files will be 320 files. (Total size is 320k byte / 1k byte = 320 files)

In case of 23 points type, configuration of Web file storage area is required. It is possible to separate 64k bytes sector into some size with 1k byte unit by user’s definition. This configuration should be done using system configuration page.

### ⚠ Caution!!

Be careful when Web file storage area configuration is done, stored all files will be deleted. Please make back up of stored files before do this configuration. Refer to “Chapter 13 – Configuration” for details.



## (2) IP address settings

This function is used for network settings including IP address, DNS server and NTP server. The following table shows initial factory settings.

Table 6.4 IP address factory settings

	Item	Factory Settings
1	Node Name	EH-WD10DR
2	MAC Address	MAC Address of this unit
3	IP Address	192.168.0.1
4	Subnet Mask	255.255.255.0
5	Default Gateway	(Not set)
6	DNS Server	(No checks)
7	Primary DNS Server	(Not set)
8	Secondary DNS Server	(Not set)
9	NTP Server	(No checks)
10	NTP Server Address	(Not set)
11	NTP Server Access Time	0[Hr] 1[Min]
12	Time zone	GMT+09:00

**⚠Caution!!**

Note that Web Controller must be restarted to reflect changes to IP address. Make sure to go through the restarting process using this function to restart, but never shut off and re-supply the power for the purpose. Refer to “Chapter 13 System Configuration” for details.

## (3) E-mail settings

This function is used for settings for sending e-mails.

There are two areas to be set. One is for basic settings for e-mail address and server, and the other is for mail trigger settings to define criteria of outgoing e-mails. Factory settings leave these areas undefined. Be sure to set this before using when using the e-mail sending function.

**⚠Caution!!**

Note that mail trigger function can be set only after e-mail basic settings are completed. Refer to “Chapter 13 System Configuration” for details.

Please be informed that not all e-mail servers are proven to support the send e-mail function.

## (4) Ethernet protocol settings

This function is used for the settings of communication using Ethernet protocol.

Passive HIProtocol and message communication settings are required for Ethernet protocol. The following table describes factory settings of Ethernet Passive HIProtocol. As for the Ethernet message communication function, factory settings leave it undefined. Be sure to set this before using when using this function.

Table 6.5 Ethernet HIProtocol factory settings

	Item	Factory Settings
1	Task Code Port1	TCP/IP
2	Task Code Port1 Port No.	3004
3	Task Code Port2	TCP/IP
4	Task Code Port2 Port No.	3005
5	Task Code Port3	TCP/IP
6	Task Code Port3 Port No.	3006
7	Task Code Port4	TCP/IP
8	Task Code Port4 Port No.	3007
9	Port Timeout	Enable
10	Port Timeout Value	30

## (5) Serial port settings

10 points type supports RS-232C only. 23 points type supports not only RS-232C but also RS-422/485.

Active HIProtocol, Passive HIProtocol and General Port settings are required for Serial protocol. Factory settings leave these areas undefined. Be sure to set this before using when using this function.

 **Caution!!**

Active HIProtocol, Passive HIProtocol and General Port can not be used at the same time. Note that the setting of the one currently in use will be changed to “Not Use” status when the setting of another is changed to “Use.” Refer to “Chapter 13 - System Configuration” for details.

(6) ID/Password settings

This function is used for access authorization settings for files stored in Web Controller.

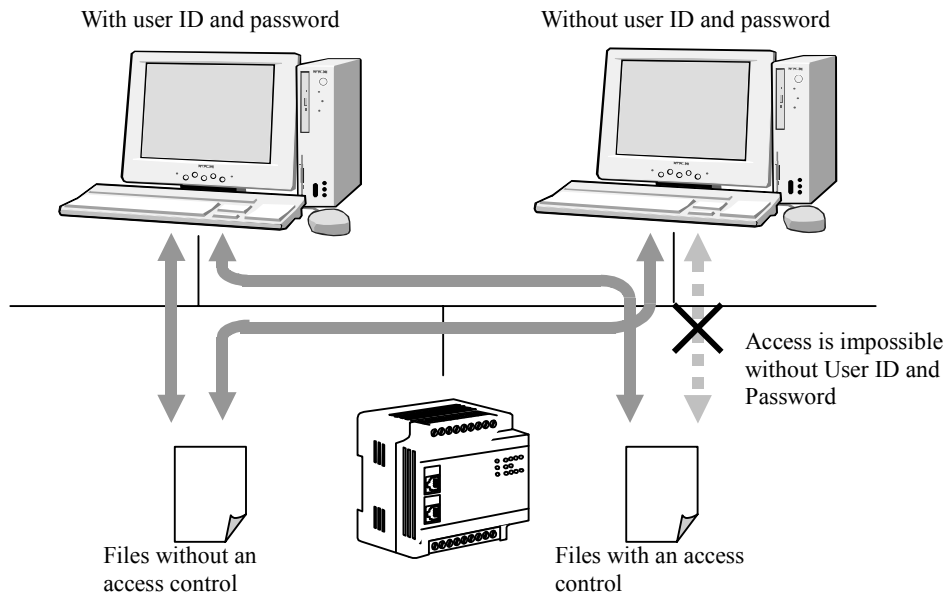

Figure 6.4 File access authorization

Access authorization needs to be set for each file. The following table describes available access authorization setting options.

Table 6.6 Available access authorization setting options

	Setting Options
1	Accessible without User ID nor Password
2	Accessible only with User ID and Password
3	Not accessible even with User ID and Password

No access authorizations are set for the three files stored as factory settings in Web Controller. They are accessible without User ID or Password.

(7) Change password for mail settings

This function is used for changing a password to log in the mail setting page.

**⚠ Caution!!**

The initial password to log in to the main settings screen is “**1111**.” Unchanged password means leaving a security hole open. Make sure to change the password for the main settings page.

Refer to “Chapter 13 - System Configuration” to change the password.

## (8) Change password for I/O set

This function is used for changing the password for I/O set.

**⚠ Caution!!**

The initial password for I/O set is "**1111**." Unchanged password means leaving a security hole open. Make sure to change the password for the I/O set.

Refer to "Chapter 13 System Configuration" to change the password.

## (9) Analog input/output settings (23 points type only)

This function is used for setting analog input/output settings. Followings are the settings as a factory setting.

Table 6.7 Analog input/output factory setting

	Item	Factory setting
1	Input Channel No.1	Voltage
2	Input Channel No.1 - Moving average	Enable
3	Input Channel No.1 – Number of Sampling	16
4	Input Channel No.2	Voltage
5	Input Channel No.2 - Moving average	Enable
6	Input Channel No.2 – Number of Sampling	16
7	Output mode	mode 1

**⚠ Caution!!**

This function is available only 23 points type.

Refer to "Chapter 13 - System Configuration" for details of Setting items.

## (10) SNMP agent function settings (23 points type only)

This function is used for setting SNMP agent. Up to five community names can be set.

There is no registered community name as a factory setting and mode is set "Not Use". Be sure to set this before using when using this function.

**⚠ Caution!!**

This function is available only 23 points type.

(11) Upload/Download configuration file function (23 points type only)

The configuration contents can be downloaded to PC as configuration file. And also, the configuration file can be uploaded into Web controller and set several setting. The configuration information handles by this function are IP address setting, e-mail setting, Ethernet setting, serial port setting, analog input/output setting and SNMP setting. Be careful that this function cannot support Super User Information, Web files, ID/Password, E-mail attention edition page password and I/O setting password.

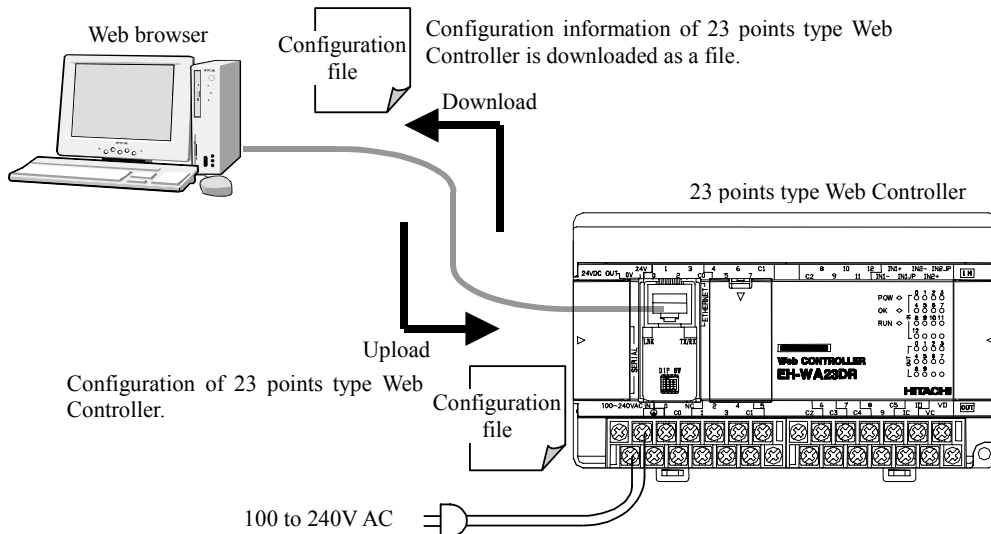

Figure 6.5 Upload/Download configuration file function

Table 6.8 Configuration information handled by Upload/Download configuration file function

	Item	Configuration information Handled by this function (○: handled, ×: not handled)
1	Super User Information	×
2	Related setting of Web file	×
3	IP address setting	○
4	E-mail setting	○
5	Ethernet protocol setting	○
6	Serial port setting	○
7	ID / Password setting	×
8	Password of e-mail attention edition page	×
9	Change of password for I/O set function	×
10	Analog input/output setting	○
11	SNMP agent function setting	○

**⚠ Caution!!**

This function is available only 23 points type.

## 6.3 Browsing Web pages

Web Controller is equipped with HTTPD (Hyper Text Transfer Protocol Daemon) which enables users monitoring and setting of the data in the unit, and dedicated CGI (Common gateway Interface) for a Web server function.

The following flow chart describes the browsing process of Web pages stored in Web Controller.

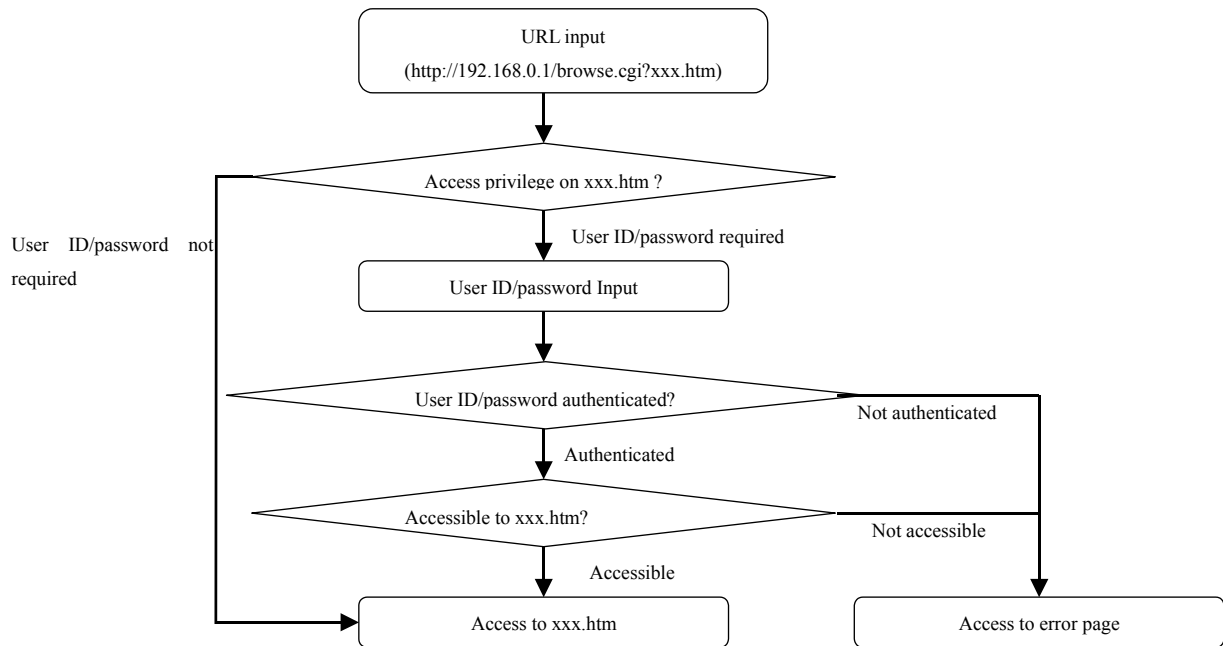

Figure 6.6 Access flow chart

### ⚠ Caution!!

The above figure illustrates an access flow with the factory setting IP address “192.168.0.1.” If IP address has been changed, you should enter the IP address after the change. Further, the above example uses a file name “xxx.htm.” Enter the file name you want to browse instead.

**Browsing the HTML files in Web Controller via a Web browser**

When Web Controller receives a request from a Web browser specifying an URL address for an HTML file stored in it (1], 2]), it returns the requested HTML file (3], 4], 5], 6]).

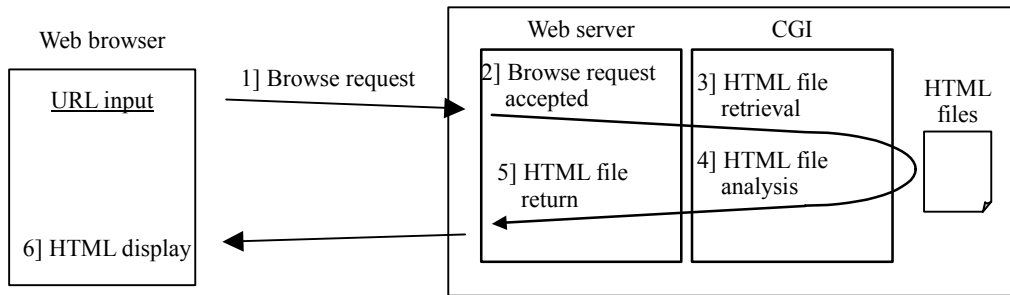

Figure 6.7 Browsing Web pages

**Reading out the values on I/O memory via a Web browser**

In order to read out values on I/O memory in Web Controller via a Web browser, users need to create an HTML file conforming to the HTML tags which have been extended based on our original specifications (“extension tags”), and also need to register the HTML file (“data read HTML file”) in Web Controller.

When Web Controller receives a browse request for an HTML file (1]), CGI analyzes the HTML file (2], 3], 4]) and checks if the file has an extension tag. If the HTML file contains an extension tag, CGI retrieves the values on I/O memory and create a temporary HTML file to be sent back (5]). Web server sends back the temporary HTML file to the Web browser (6], 7]).

This means that users can read out values on I/O memory in Web Controller via a Web browser by using CGI and extension tags.

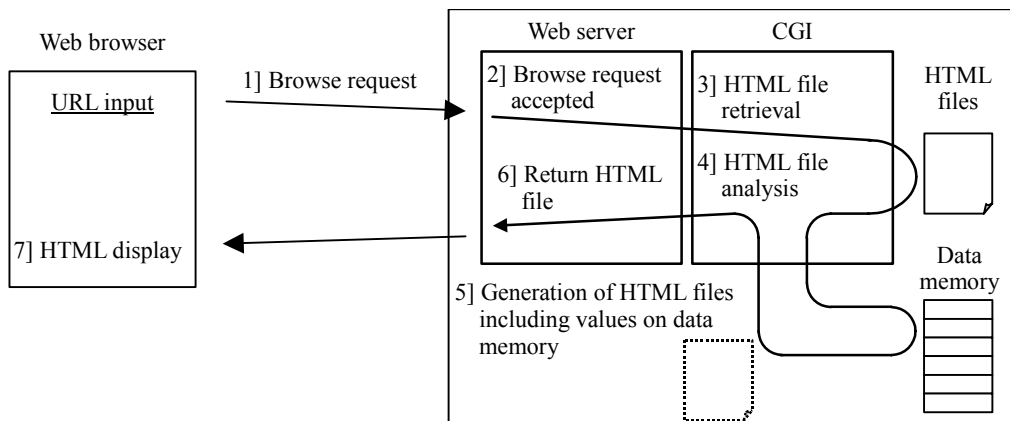

Figure 6.8 Reading out the values of I/O memory via a Web browser

### Setting the values on I/O memory via a Web browser

In order to set values on I/O memory in Web Controller via a Web browser, users need to create an HTML file conforming to the FORM tag, INPUT tag and SELECT tag as well as to the INPUT tag attribute format, SELECT tag attribute format and I/O pass tag that we independently defined, and to register the HTML file (“dataset HTML file”) in Web Controller.

When receiving a browse request for a dataset HTML file (1]), CGI returns the requested HTML file (2], 3], 4], 5]). Then, the Web browser displays a page including input boxes, check boxes, pull-down menus and others (6]). Users input or select values they want to set (7]), and submit the dataset request (8]) on this page. When Web Controller receives the dataset request (9]), it analyzes whether the I/O pass tag is defined to require a password (10]). If a password is required, the Web browser displays a password authentication page (11]). When a password is entered on the password authentication page (12]) and accepted (13], 14], 15]), the submitted data is written in the specified I/O number area on data memory, and the referenced page is displayed on the Web browser again (16], 17]). If no password is required, the submitted data is written in the specified I/O number area on data memory, and the referenced page is displayed on the Web browser again (16], 17])

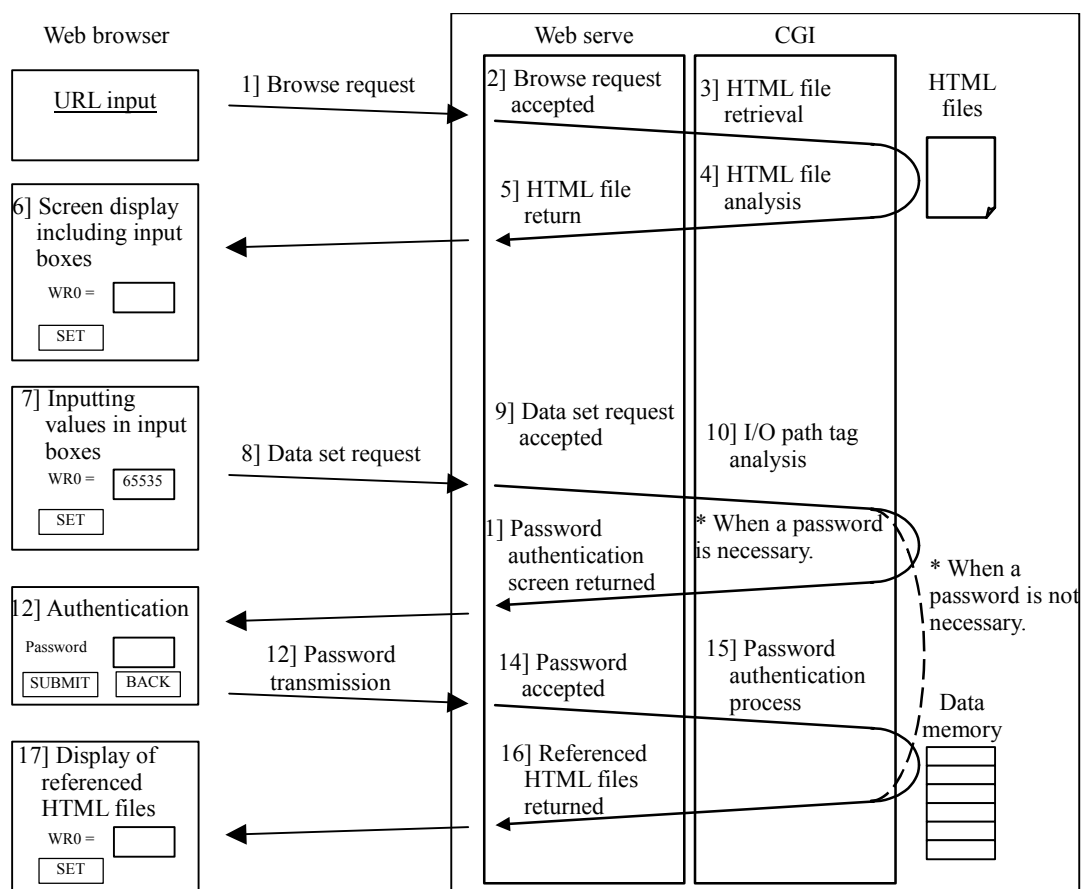

Figure 6.9 Setting values on I/O memory via a Web browser



(1) Simultaneous access to Web Controller

Web Controller controls a maximum of 6 sessions with a Web browser. A session as defined and controlled by Web Controller starts when a Web browser submits a browse request for an HTML file and ends when Web Controller returns the file.

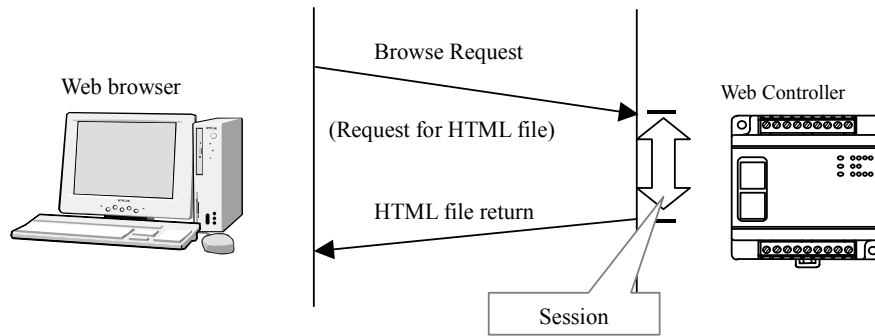

Figure 6.10 Session

Therefore, after Web Controller receives a browse request from a Web browser for an HTML file, it can receive up to five more browse requests for the same or other files before returning the initially requested HTML file.

If browse requests exceeding six sessions are made, the Web browser will not receive the requested HTML file to display as a Web page. If no page is displayed, you need to submit the browse request again via the Web browser.

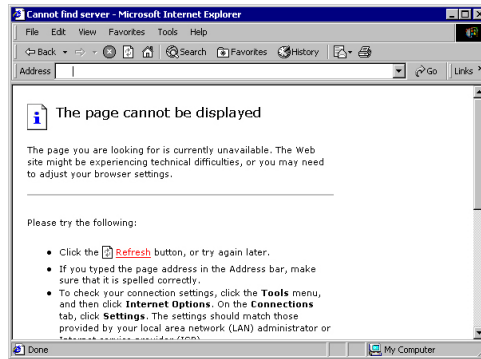

Figure 6.11 When browse requests are submitted in excess of maximum number of sessions

If you use the FRAME tag to display multiple Web files on the same Web page, you should consider this maximum possible number of sessions when making up frame compositions. Also, the larger the file size is, the longer it takes Web Controller to return the Web file. This means that one session is retained for a longer period of time, causing situations where other Web files may not be displayed.

The figures below show the difference of retained sessions depending on the size of HTML files stored in Web controller. Figure 6.12 illustrates session operation of small size files, while that of large size files is shown in Figure 6.13.

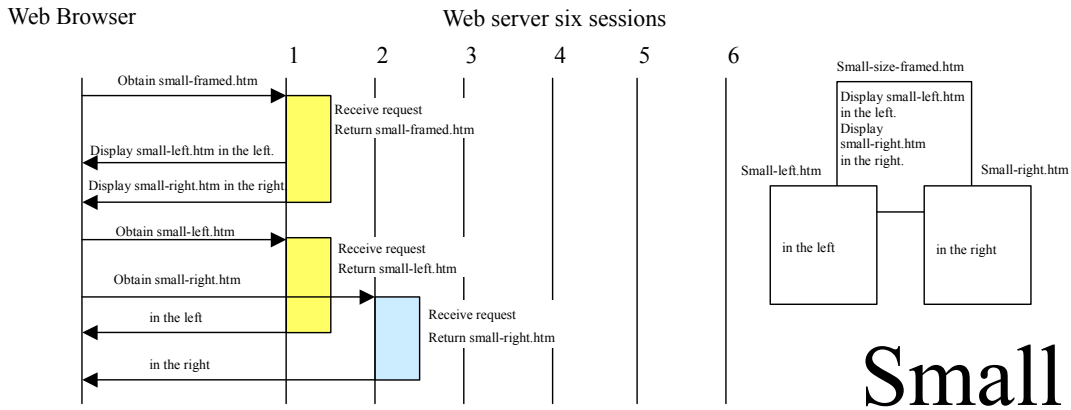

Figure 6.12 Web server – six session operation: small file size

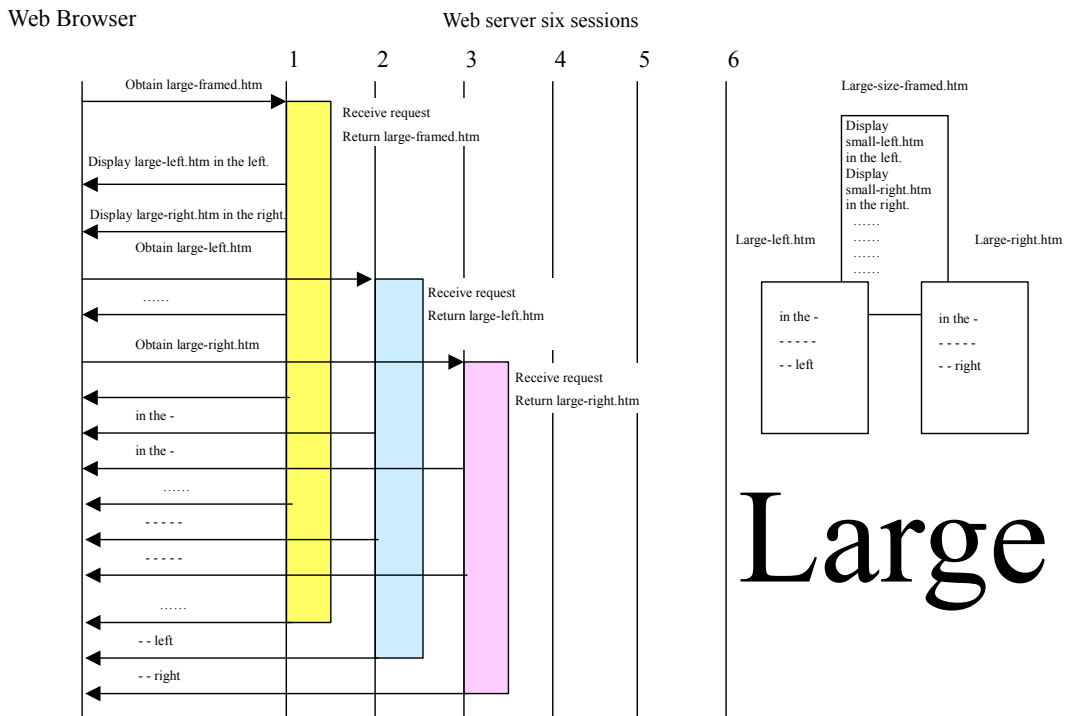

Figure 6.13 Web server – six session operation: large file size

## 6.4 E-mail Settings

If a mail trigger is already set on System Configuration, it is simple and easy to edit e-mail settings. This function enables you to quickly reflect an address change of a mobile phone or other e-mail account to the e-mail address book of Web Controller.

Access the following address to the mail settings page. Refer to “Chapter 8 – E-mail Settings with a Mobile Phone” for details.

Table 6.9 An example of URL statement to access the E-mail Address Book Editor CGI

	URL statement	Remarks
1	<p><a href="http://192.168.0.1/mailsetting.cgi">http://192.168.0.1/mailsetting.cgi</a></p> <p>IP address</p> <p>E-mail Settings CGI</p>	When accessing to e-mail address book editor CGI with the factory default IP address.

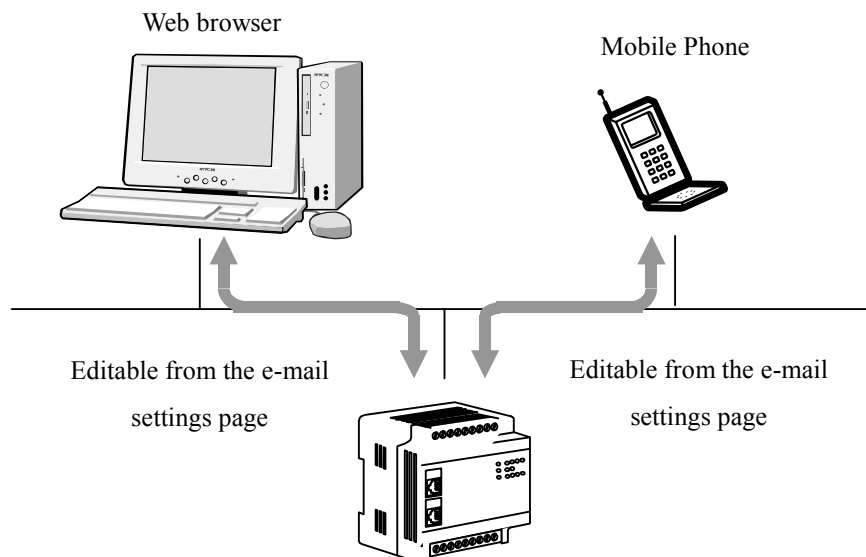

Figure 6.14 Access diagram to the e-mail settings page

### ⚠ Caution!!

To access the mail settings page from a mobile phone, Web Controller needs to be connected Internet using not the private address which can use only inside LAN like table 6.10 but the global address.

# Chapter 7 E-mail Sending Function

## 7.1 E-mail sending function

Web Controller supports SMTP (Simple Mail Transfer Protocol), and it is possible to send e-mails to mail servers on a network.

Web Controller sends an e-mail when it detects the change of a signal from OFF to ON in the bit data (I/O type is “R”) specified as an e-mail sending request trigger. The following table describes the specifications of the e-mail sending function.

Table 7.1 Specifications of e-mail sending function

Item	Specifications
Mail Server Protocol	SMTP(Simple Mail Transfer Protocol)
User Authentication	POP before SMTP (Account: 1 - 64 one byte characters, Password: 1 - 64 one byte characters)
Encryption	None
Server Configuration	Compatible with DNS.
	SMTP server: Up to 64 one byte characters. POP server: Up to 64 one byte characters.
Registration of E-mail address	One address up to 56 one byte characters.
Triggers	16 triggers (Settable from R0 - 7FF) The signal set as a trigger for sending e-mails should be ON for one second or longer.
Number of Registerable Addresses	Up to 8 per trigger: up to 56 one byte characters.
Subject	Up to 32 double-byte characters (64 one byte characters).
Body	Up to 128 double-byte characters (256 one byte characters).
Data	3 words (selected from WR0 - 3FFF, F000 - 1A9F, comment: up to 16 one byte characters).

Parameters necessary for sending e-mails should be set on a MWConfig page accessible via a Web browser.

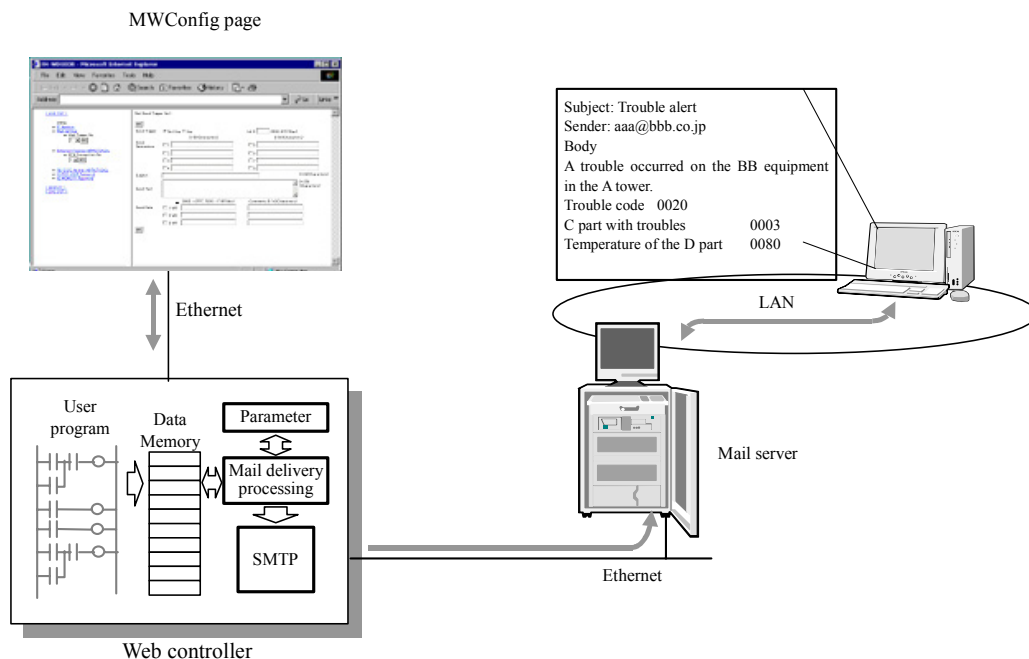

Figure 7.1 Outline of mail sending function

E-mail sending operation (when DNS is used)

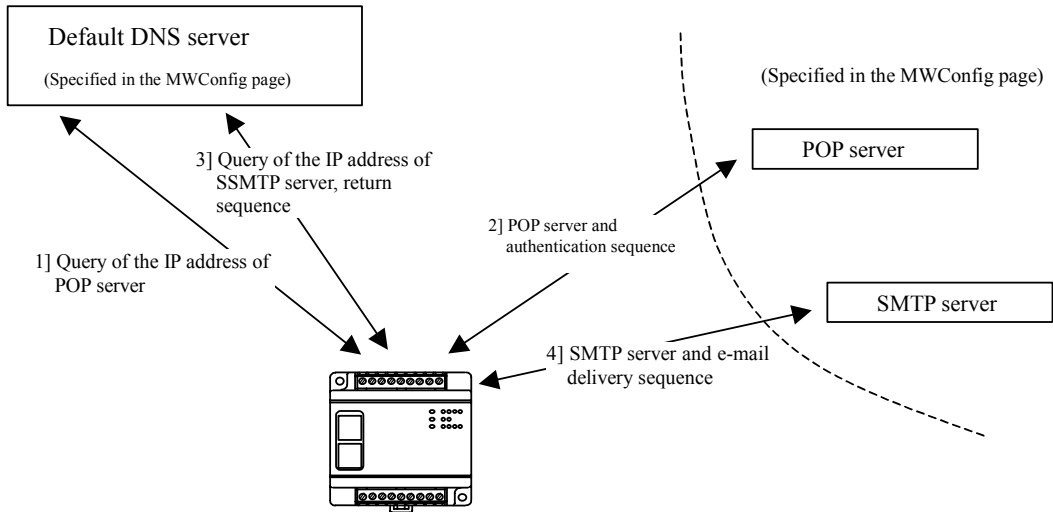

Figure 7.2 E-mail sending operation

**⚠ Caution!!**

There is no guarantee of proper operation for any combination of DNS servers and mail servers.

## 7.2 User program sample for sending e-mails

The following is a sample user program for sending e-mails with Web Controller.

External output for sending e-mails: X0

Trigger for sending e-mails: R0

Sample program

[When X0 is an ON pulse for 1 second or longer]



[When X0 is not an ON pulse for 1 second or longer]

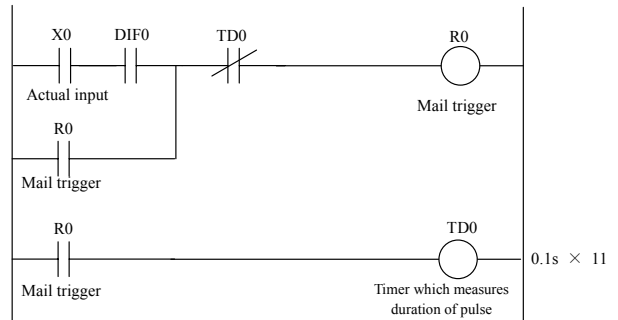

Figure 7.3 Sample user program for sending e-mails

# Chapter 8 E-mail Settings with a Mobile Phone

## 8.1 E-mail Settings

Web Controller provides a dedicated e-mail settings screen. Using the screen, users can refer to or change addresses for each trigger by specifying e-mail sending triggers to the e-mail setting information configured on the MWConfig page via a Web browser.

The editor screen is compatible with CTML to enable the reference and configuration from mobile phones.

### (1) Access to the e-mail settings screen

To access the e-mail settings, enter a URL according to the description in the Table 8.1.

Table 8.1 An example of the URL statement to access the mail settings page

URL statement	Remarks
<p>http://192.168.0.1/mailsetting.cgi</p> <p>└── IP address of Web Controller</p> <p>└── E-mail Settings Page Program</p>	<p>When accessing to the Web page for editing e-mail addresses with the factory default IP address.</p>

### ⚠ Caution!!

To access the e-mail settings page from a mobile phone, Web Controller needs to be connected Internet using not the private address which can use only inside LAN like table 8.1 but the global address.

After the input of the above URL, a screen for entering a password is displayed as shown in Figure 8.1. The password should be the one specified in the System Configuration page.

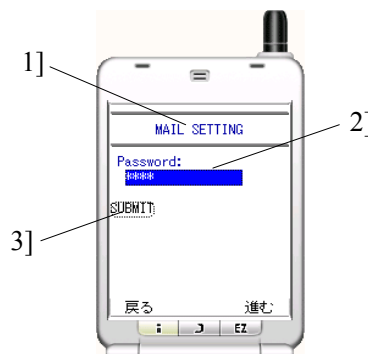

Figure 8.1 E-mail Settings - Password Input Screen

Name of Screen		Password Input Screen	
No	Name	Contents	Remarks
1]	Title	Displays the title of the e-mail settings screen.	
2]	Password Input Field	Field for the input of password to use this function.	Valid input format: One byte character (upper and lower cases) 1 - 16 digits
3]	Password Input Button	For the password authentication of the input password.	

\* Passwords can be changed in “The password setting for e-mail address” in the System Configuration screen.

\* Passwords input in the above 2] are displayed in asterisks (\*).

(2) Selection of mail triggers for reference or change

After the password match is confirmed, “Subject” of mails is displayed if valid mail sending triggers exist.

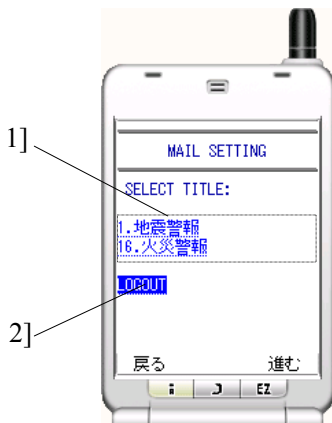

Name of Screen		Screen to select contents for edit and subject of the mail	
No	Name	Contents	Remarks
1]	Subject of mail List of links	Select the subject of the e-mail for editing mail addresses.	Title Display Mode: X.Y X: Mail Trigger Number Y: Subject of mail
2]	Link to Logout	Press the button to log out from the screen.	Return to the password input screen after the logout.

\* Only the subjects of mails with a valid trigger are displayed.

Figure 8.2 E-mail Settings – E-mail Subject Selection Screen

(3) E-Mail Settings

Select the “Subject” of a mail, and the addressees of the mail will be displayed.

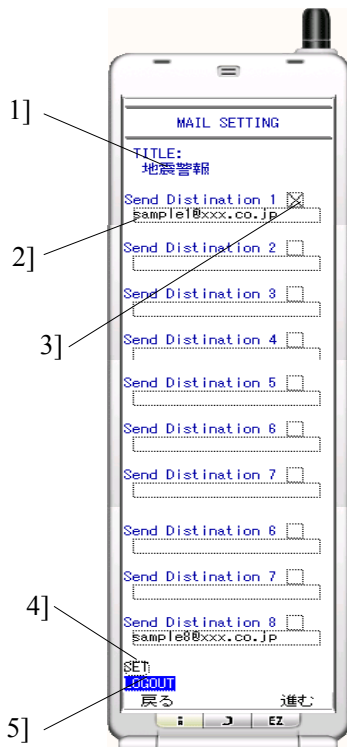

Name of Screen		E-mail Address Book Editor Screen (sorted by mail subjects)	
No	Name	Contents	Remarks
1]	E-mail subject for edit	Displays the subject of the mail in edit.	
2]	E-mail address input field	Input E-mail addresses in this field.	Valid input format: One byte character (upper and lower cases), numeric and symbols. 1 - 16 digits
3]	Checkbox for e-mails to be sent	Check the box for e-mails to be sent.	Checked: Enabled Unchecked: Disabled
4]	Registration Button	Registers the input E-mail address.	
5]	Logout Button	Press the button to log out from the screen.	Return to the password input screen after the logout.

\*As the trigger to be edited is enabled, if there is no valid address, it causes an error.

Figure 8.3 E-mail Settings Screen

## (4) Registration of e-mail addressees

Specify addressees of the e-mail, and the following screen will be displayed.

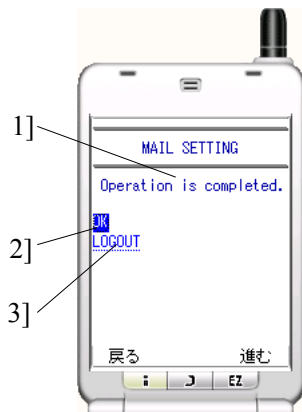

Name of Screen		E-mail Address Registration Completion Screen	
No	Name	Contents	Remarks
1]	Message	Displays the result of operation.	
2]	Message Confirmation Button	Return to the screen to send the subject of a e-mail.	
3]	Link to Logout	Press the button to log out from the screen.	Return to the password input screen after the logout.

Figure 8.4 E-mail Address Registration Screen

## (5) Error message

Table 8.2 E-mail address book editor - List of Error Messages

No	Error Message	Contents and Measures
1	Mail server is not setting.	Displayed when a mail server is not specified in the MWConfig page. Set up a mail server.
2	Trigger is not found.	Displayed when a mail trigger is not set.
3	ERROR: Input passwaord is not correct.	Displayed when the input password does not match. Check the password set in the "System Configuration" page.
4	ERROR: Registration error	Displayed when the registration does not end properly. Check if the input format is valid.

### ⚠ Caution!!

Operation is confirmed with the Microsoft Internet Explorer and NTT DoCoMo i-mode.  
There is no guarantee of proper operation for any Web browser or mobile phone.



***MEMO***

# Chapter 9 Ethernet communication

## 9.1 Ethernet Communication Function

Web Controller has the following two kinds of Ethernet communication function.

### Ethernet task code communication

This task code communication is a dedicated protocol for Hitachi H/EH series Programmable Controllers.

### Ethernet message communication

Data communication format which does not specify protocol such as commands between Web Controller and an upper host.

## 9.2 Ethernet task code communication

The following functions can be achieved by combining individual communication commands in an upper host program.

- (1) CPU Control (occupy/release, CPU status read, etc.)
- (2) I/O control (various type of monitoring)
- (3) Memory write (all clear, batch transfer, etc.)
- (4) Memory read (reading of programs, etc.)
- (5) Response (various responses from a CPU)

With this function, it is possible to establish a system using a touch panel such as HMI software (SCADA, etc.) supporting Hitachi H/EH series PH Ethernet communication.

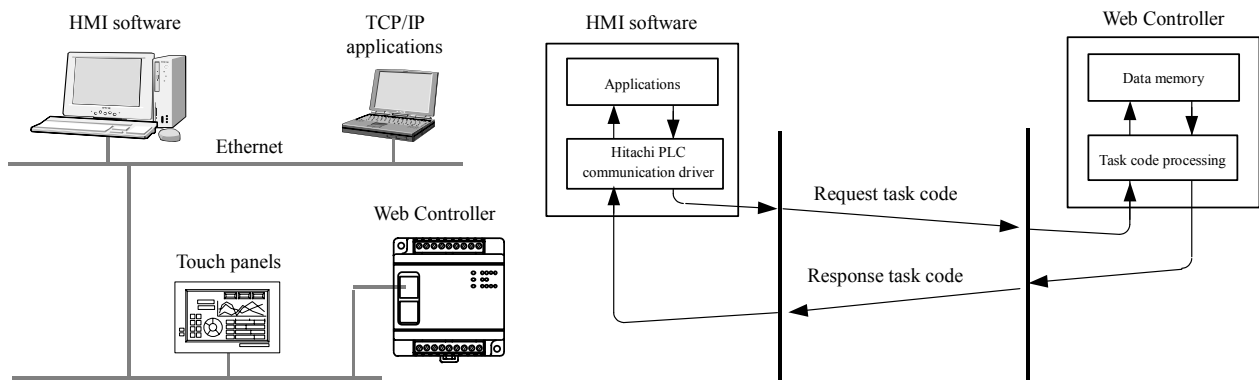

Figure 9.1 Composition of task code communication equipment

Table 9.1 Task code communication specifications

Item	Specifications
1 Command System	Hitachi H/EH series PLC Ethernet task code (server function). (Refer to “Controller Manual, Appendix 2: Task Codes” for details.)
2 Communication Protocol	TCP/IP, UDP/IP
3 Logical Port	Up to 4 (Select any from 1024 - 65535)

## 9.3 Ethernet message communication

Message communication function is useful for sending active messages from Web Controller to an upper host when an event occurs or receiving message data from an upper host at any time, and communication procedures according to the system can be established.

Table 9.2 Ethernet message communication specifications

	Item	Contents
1	Communication Protocol	TCP/IP, UDP/IP
2	Connections	Up to 6
3	Maximum length of messages	Up to 730 words.
4	Sending Area	WX* <sup>1</sup> WY* <sup>1</sup> Specify from WR0 - 3FFF. Specify from WM0 - 3FF.
5	Receiving Area	WY* <sup>1</sup> Specify from WR0 - 3FFF. Specify from WM0 - 3FF.

\*1 It is possible to specify the area where I/O was assigned to the area WX and WY.

### Communication type

Followings three types can be specified as communication type.

Table 9.3 Ethernet message communication - Communication type

	Type	Contents
1	Transmission / Reception	Performs transmission and reception of messages to the other station.
2	Transmission only	Performs transmission of messages to the other station only.
3	Reception only	Performs reception of messages only.

Connection typeAbout TCP/IP-Active and TCP/IP-Passive

When sending messages using TCP/IP, logical transmission path for the connection with an open request should be established between Web Controller and the other station. There are two methods to establish connection.

Table 9.4 Ethernet message communication - Connection types

No	Connection type	Contents
1	Active Open	<p>A method to establish connection by sending an open request later to the other station which is waiting for the connection open.</p>
2	Passive Open	<p>Waiting for the connection open, and establish connection by receiving an open request from the other station.</p>

About “Specified” and “Optional” for the other station

Message communication can be achieved with any station if a TCP/IP-Active station is specified or UDP/IP reception is specified.

Send Broadcast

“Transmission/Reception” or “Transmission only” is specified using UDP/IP, data can be exchanged between logical ports which meet the following requirements.

- (1) Nodes with the same network address (multiple other stations)
- (2) Nodes with the same logical port which can achieve the UDP/IP communication (multiple other stations)
- (3) Nodes in status which can receive messages (multiple other stations)

This is called simultaneous transmission or “Send Broadcast.”

Transmission Type

There are two transmission types described below.

Table 9.5 Ethernet message communication - Transmission types

Type	Contents
1 Event Send	<p>When the specified event sending trigger changes from OFF to ON, the data on the specified Sending Area of the I/O memory will be sent. The trigger should be ON for one second or longer for transmission.</p>
2 Cyclic Send	The data on the specified Sending Area of the I/O memory will be sent in a constant cycle with the interval specified with Cyclic Send Timer (1 - 65,535 seconds.)

Depending on the combination of the communication type, communication type and transmission type, items to be set are different. Items which require settings are described in the followings table:

Table 9.6 Ethernet message communication - Items to be set

Communication Type	Connection Type	Transmission Type	Web Controller Port No.	Web Address	Other Stations' IP Address	Other Stations' Port No.	Event Send Trigger Bit	Cyclic Send Timer	Sending Area Information	Receiving Area Information	Status Register	Control Register
1 Transmission/Reception	TCP/IP-Active	Event Send	0	0	0	0	-	0	0	0	0	0
		Cyclic Send	0	0	0		0	0	0	0	0	0
	TCP/IP-Passive Specified	Event Send	0	0	0	0	-	0	0	0	0	-
		Cyclic send	0	0	0		0	0	0	0	0	
	TCP/IP-Passive Optional	Event Send	0	-	-	0	-	0	0	0	0	-
		Cyclic Send	0				0	0	0	0	0	
	UDP/IP Specified	Event Send	0	0	0	0	-	0	0	0	0	-
		Cyclic Send	0	0	0		0	0	0	0	0	
	UDP/IP Optional	Event Send	0	-	0	0	-	0	0	0	0	-
		Cyclic Send	0	-	0		0	0	0	0	0	
2 Transmission only	TCP/IP-Active	Event Send	0	0	0	0	-	0	-	0	0	0
		Cyclic Send	0	0	0	-	0	0	-	0	0	0
	TCP/IP-Passive Specified	Event Send	0	0	0	0	-	0	-	0	0	-
		Cyclic Send	0	0	0		0	0	0	0	0	
	TCP/IP-Passive Optional	Event Send	0	-	-	0	-	0	-	0	0	-
		Cyclic Send	0				0	0	0	0	0	
	UDP/IP Specified	Event Send	0	0	0	0	-	0	-	0	0	-
		Cyclic Send	0	0	0	-	0	0	-	0	0	-
	UDP/IP Optional	Event Send	0	-	0	0	-	0	-	0	0	-
		Cyclic Send	0	-	0	-	0	0	-	0	0	-
3 Reception only	TCP/IP-Active	Event Send	0	0	0	-	-	-	0	0	0	
		Cyclic Send	0	0	0				0	0	0	
	TCP/IP-Passive Specified	Event Send	0	0	0	-	-	-	0	0	-	
		Cyclic Send	0	0	0	-	-	-	0	0	-	
	TCP/IP-Passive Optional	Event Send	0	-	-	-	-	-	0	0	-	
		Cyclic Send	0	-	-	-	-	-	0	0	-	
	UDP/IP Specified	Event Send	0	0	0	-	-	-	0	0	-	
		Cyclic Send	0	0	0	-	-	-	0	0	-	
TCP/IP-Passive Specified	Event Send	0	-	0	-	-	-	0	0	-		
	Cyclic send	0	-	0	-	-	-	0	0	-		

0: Specifying parameters is required for the communication.  
- : Specifying parameters is not required for the communication.

Sending Area / Receiving Area Information

In the message communication, areas in the I/O memory which store the data to be sent, and which store the receiving data, should be specified.

Table 9.7 Ethernet message communication - Sending Area / Receiving Area Information

	Type	Contents	Available I/O memory area	Allowable size
1	Sending Area Information	I/O type	WR: 0 - 3FFF	WR: 1 - 730 words
		First I/O number	WM: 0 - 3FF WX: *1	WM: 1 - 730 words WX: *1
		Size (words)	WY: *1	WY: *1
2	Receiving Area Information	I/O type	WR: 0 - 3FFF	WR: 1 - 730 words
		First I/O number	WM: 0 - 3FF	WM: 1 - 730 words
		Size (words)	WY: *1	WY: *1

\*1 It is possible to specify the area where I/O was assigned to the area of WX and WY.

Status Register and Control Register

The followings table describes the contents of Status Register and Control Register related to the message communication.

Table 9.8 Status Register and Control Register

No	Category	Name of register	Contents
1	Status Register	1] Receiving Counter	Stores the number of times packet data is received. Specify the word I/O number. Receiving Counter is not updated when the packet exceeding the maximum number of words specified in the Receiving Area is received.
		2] Sending Counter	Stores the number of times packet data is sent. Specify the word I/O number.
		3] Close Flag	“1” is set when the connection is cut off from the other station. Specify the bit I/O number. No close flag is set during the connection retry processing. The system does not clear the bit I/O specified as a close flag.
		4] Receiving Overflow Buffer	Receiving buffer overflow means that a packet exceeding the word number specified in the Receiving Area is received. When receiving buffer overflow is detected, the specified word I/O number is incremented by “1.” The system does not clear the I/O specified in the receiving buffer overflow.
		5] Open Flag	“1” is set when the connection is open, and “0” when the connection is closed. Specify the bit I/O number.
2	Control Register	1] Reopen Request Bit	Specify the bit I/O number. When the connection is closed (open flag is “0”), connection open request is issued by setting “1” to this bit. The system clears the I/O specified in the reopen request bit immediately after connection open process starts.
		2] Number of Retry Times	Specify the number of retry times for the connection open.
		3] Retry Interval	Specify the retry interval for the connection open.

Number of retry times and retry interval for connection open

When TCP/IP-Active is specified, the number of retry times and retry interval for connection open when it fails can be specified.

When there is no response to the packet with SYN flag \*1 sent from Web Controller, perform retry three times, and repeat this process for the specified number of retry times. Retry interval specifies the interval between cycles which consist of three retries.

The following describes the example when the number of retry times is set to “3,” and retry interval is set to “10 seconds.”

\*1: SYN flag is a connection open request flag.

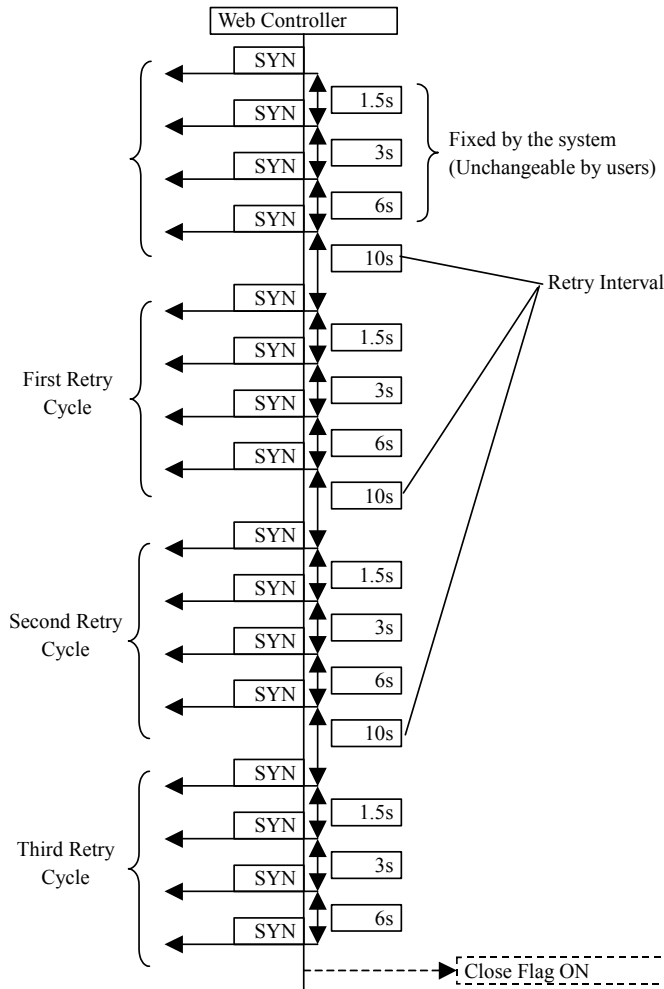

Figure 9.2 Connection Open Retry Sequence

# Chapter 10 Serial Port Communication

## 10.1 Serial Port Communication Function

Web Controller provides three types of serial port communication function as follows. To start the serial port communication, specify the usage on the MWConfig page.

### General Purpose Communication

This function uses a user program on Web Controller to issue general purpose communication instructions and communicate with externally connected devices.

### Active-HIProtocol Communication

Active-HIProtocol communication means the master function to issue the task code, which is the protocol of HITACHI H/EH series programmable controllers, by using the serial port of Web Controller.

### Passive-HIProtocol Communication

Passive-HIProtocol communication means the slave function of the task code for HITACHI H/EH series programmable controllers including Web Controller. The task code enables a master host computer to communicate with Web Controller and to control (monitor) each I/O of the controller.

## 10.2 General Purpose Communication

This communication system uses a user program for communication. This system enables communications in accordance with the communication format and protocol of external devices.

Set the serial port to “General Port” and use general purpose communication instructions (TRNS 0. RECV 0) to enable communications.

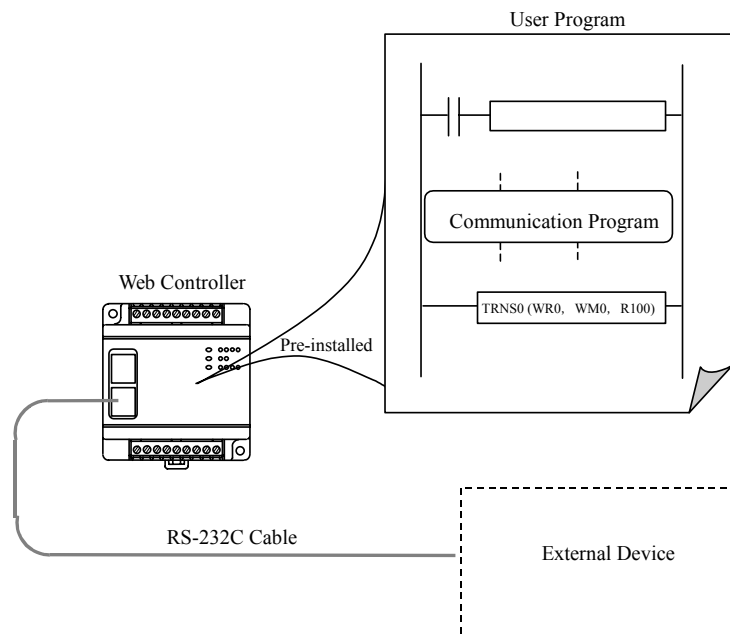

Figure 10.1 General Purpose Communication



Transmission Instruction (TRNS 0)

(1) Transmission

(2) Reception after transmission

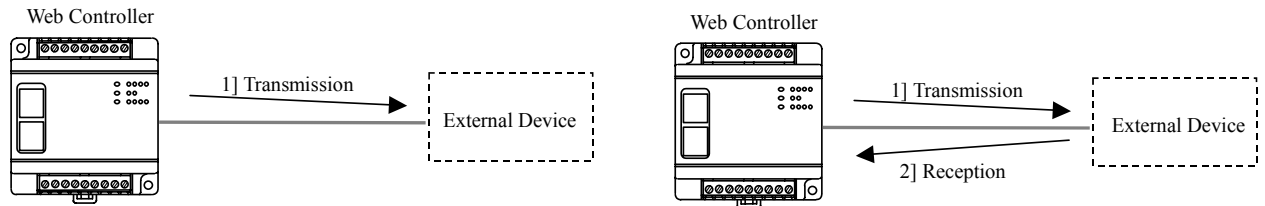

Figure 10.2 Transmission Instruction

Reception Instruction (RECV 0)

(1) Reception

(2) Transmission after reception

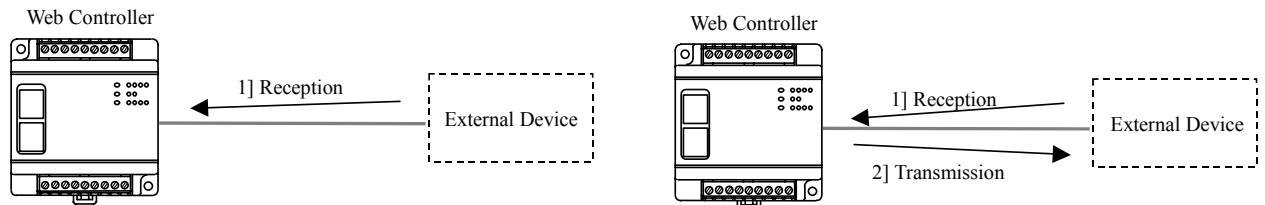

Figure 10.3 Reception Instruction

The followings table indicates the general purpose communication specifications.

Table 10.1 General Purpose Communication

Item	Specifications	
	10 points type	23 points type
Web Controller Type	EH-WD10DR	EH-WA23DR
Communication instruction	Dedicated communication instruction by Ladder program (TRNS 0/RECV 0)	
Communication speed	Select from 300, 600, 1200, 2400, 4800, 9600, 19.2k, 38.4k, 57.6k bps	Select from 300, 600, 1200, 2400, 4800, 9600, 19.2k, 38.4k, 57.6k, 115.2k bps
Communication system	Half duplex	
Synchronization	Asynchronous	
Startup system	Transmission, reception after transmission, reception, transmission after reception	
Transmission system	Serial transmission (bit serial transmission)	
Transmission code	Configured by user	
Transmission code configuration	Configured by user (7/8 data, 1 start 1, 1/2 stop, parity; selection from 7 patterns)	
Transmission code outgoing sequence	Sent out from the lowest bit in character units	
Error control	Vertical parity check, checksum, overrun check, framing check	
Transmission unit	Message unit (variable length)	
Maximum message length	1024 bytes (including control characters)	
Control procedure	Configured by user	

Refer to the Controller Manual for instruction specifications of TRNS 0/RECV 0 and a sample program.

### 10.3 Active-HIProtocol

Connecting a HITACHI H/EH series programmable controller to the serial port of Web Controller enables data transmission between the programmable controller and Web Controller. Sending/Receiving Areas can be specified on the MWConfig page.

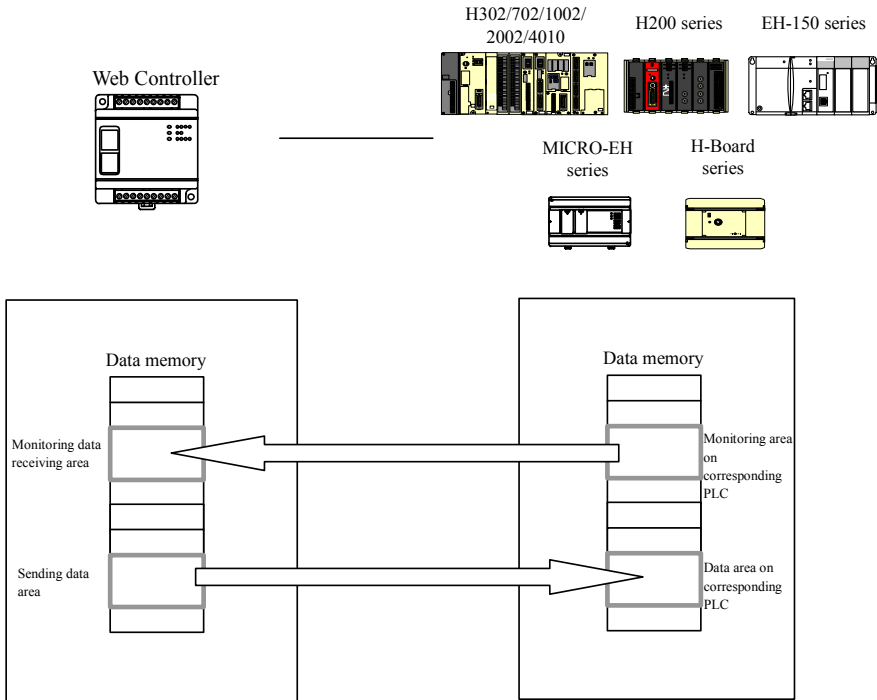

Figure 10.4 Active-HIProtocol communication function

Table 10.2 Active-HIProtocol Specifications List

Item	Specifications
Connectable programmable controller (PLC)	HITACHI Programmable Controller H-20/28/40/64, H-200/250/252, H-300/700/2000 H-302/702/1002/2002/4010, EH-150, MICRO-EH
Communication area of connected PLC	WR/WM/WL
Data transfer mode	Monitor Monitor & I/O Set/Reset Trigger (Trigger: specify R0 – R7BF) Data link (monitor and set)
Data transfer size	Read: 120 words; Write: 100 words
Communication speed	Automatic detection of communication speed of connected PLC
Communication system	Half duplex
Synchronization	Asynchronous
Startup system	One-sided startup using the host side command, LUMP address settable
Transmission system	Serial transmission (bit serial transmission)
Transmission code	ASCII
Transmission code configuration	7-bit data, 1 start, 1 stop, even parity
Transmission code outgoing sequence	Sent out from the lowest bit in character units
Error control	Vertical parity check, checksum, overrun check, framing check
Transmission unit	Message unit (variable length)
Maximum message length	503 bytes (including control characters)
Control procedure	H-series dedicated procedure (HIProtocol) Standard protocol (transmission control procedure 1), Simplified protocol (transmission control procedure 2)

### (1) Communication speed and automatic detection

Serial port communication speed of connected PLC varies depending on the model and settings. Web Controller detects the communication speed set on connected PLC and communicates at the speed.

### (2) Communication modes

#### 1) Monitor only

Web Controller reads out data on a specified area in the connected PLC, and stores the data on a specified area in Web Controller. Monitor cycle is approximately one second.

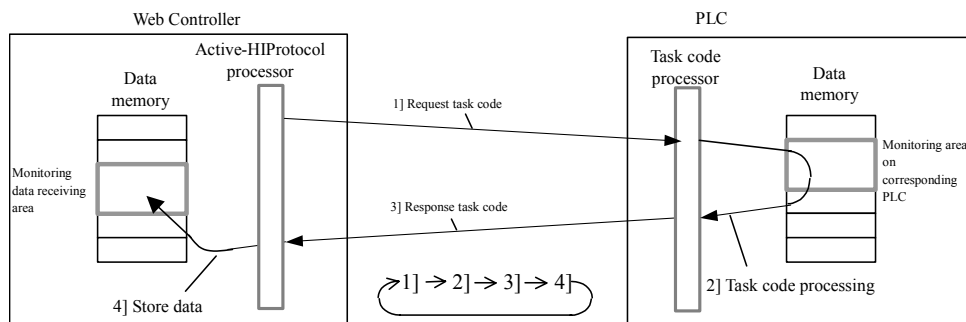

Figure 10.5 Active-HIProtocol Monitor operation

### 2] Monitor & I/O Set/Reset Trigger

In addition to Monitor operation, data on a specified area in Web Controller can be set to a specified area in the connected PLC by changing the signal in a specified bit from OFF to ON.

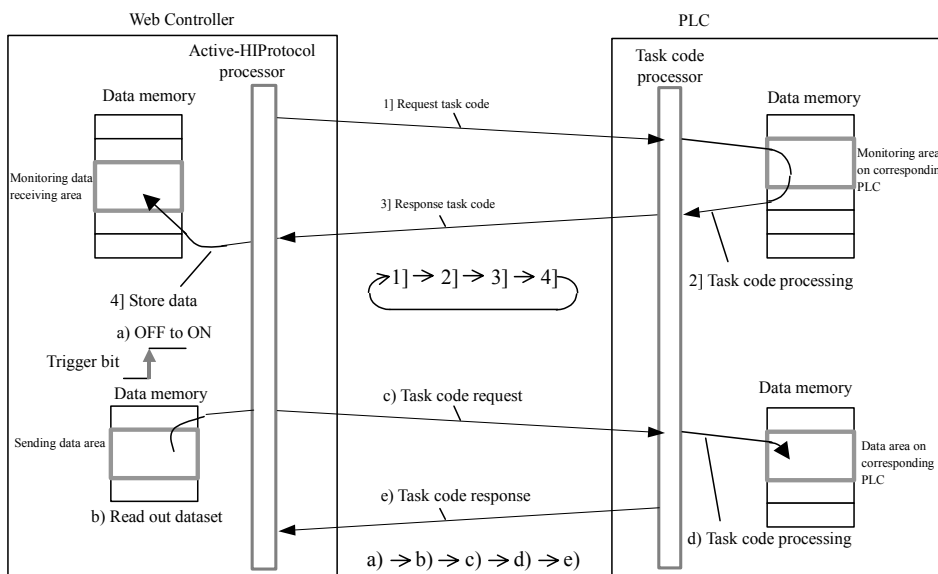

Figure 10.6 Active- HIProtocol Monitor & I/O Set/Reset Trigger

The trigger should be ON for 120ms or more.

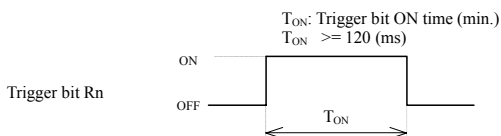

Figure 10.7 I/O Set/Reset Trigger

### 3] Data link

Monitor and Set are alternately carried out.

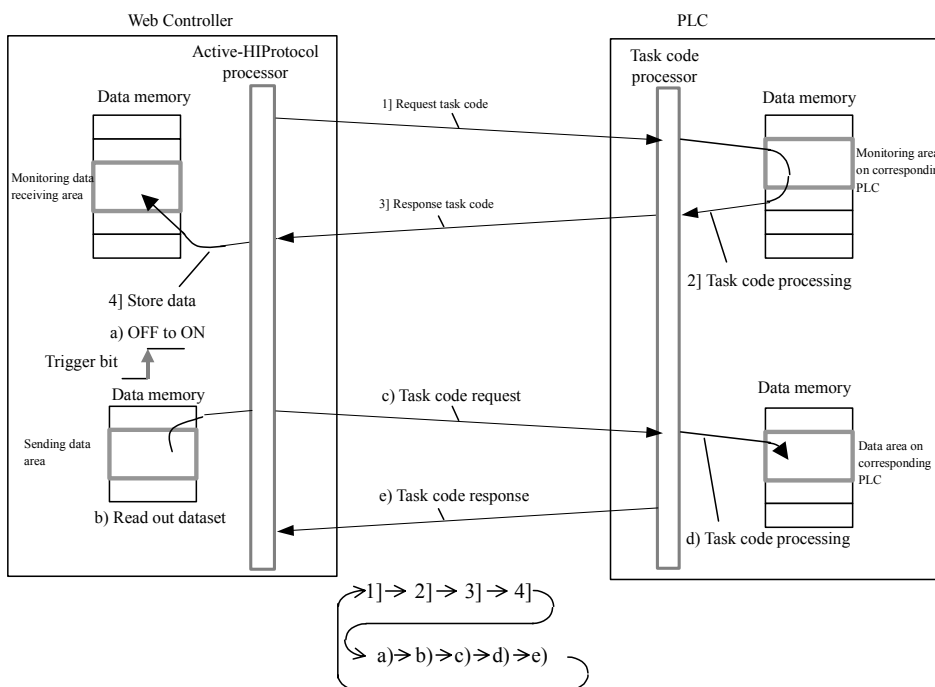

Figure 10.8 Active-HIProtocol data link

Active-HIProtocol sequence

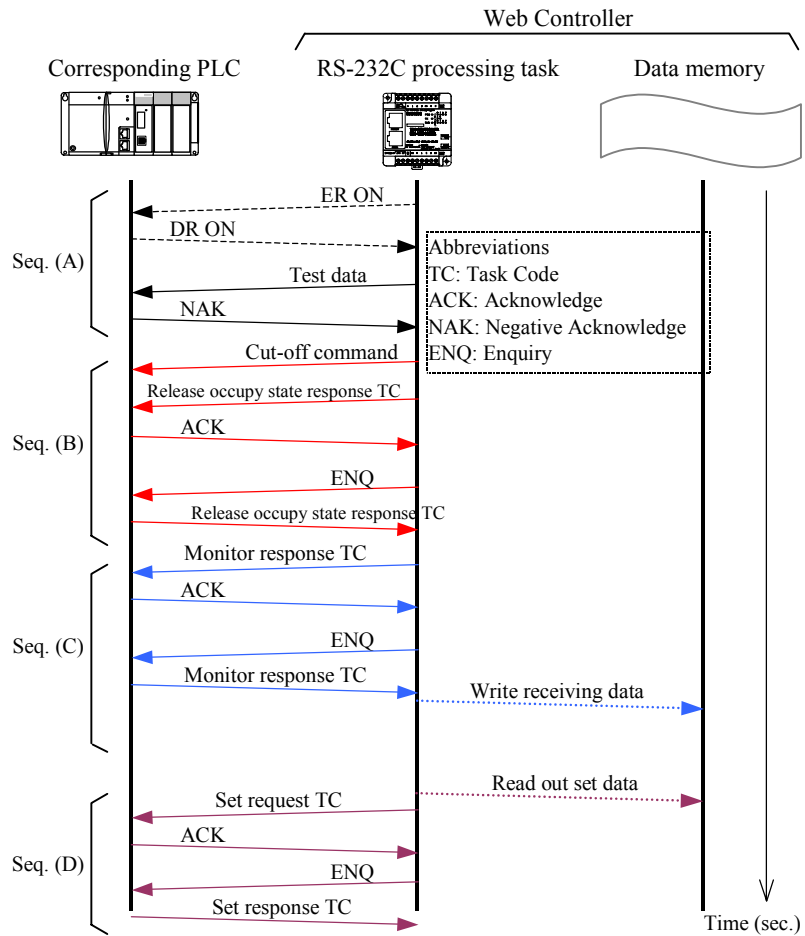

Figure 10.9 Sequence on the data link communication mode

Table 10.3 Description of sequence (data link communication mode)

Abbr.	Sequence name	Indication of the lines
Seq. (A)	Baud rate automatic detection sequence	Dotted line: control of RS-232C control line Solid line: data on line
Seq. (B)	Initial sequence	<b>Solid line:</b> data on line
Seq. (C)	Data link (monitor) communication sequence	<b>Solid line:</b> data on line <b>Dotted line:</b> internal processing
Seq. (D)	Data link (set) communication sequence	<b>Solid line:</b> data on line <b>Dotted line:</b> internal processing

## 10.4 Passive HIProtocol

This is the task code slave function of HITACHI H/EH series programmable controllers.

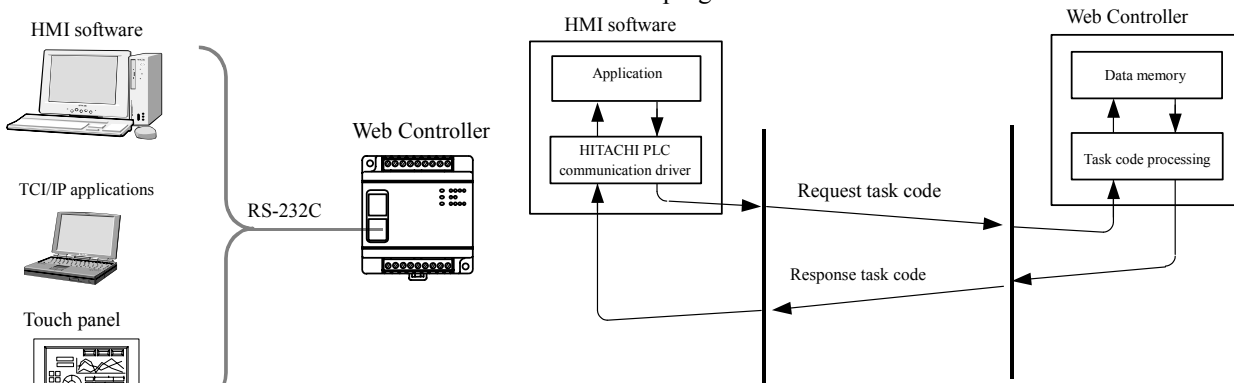

Figure 10.10 Serial port Passive HIProtocol

Table 10.4 Passive HIProtocol

Item	Specifications	
Communication speed	Dedicated port	Modem setting
	4800, 9600, 19.2k, 38.4k bps	2400, 4800, 9600, 19.2 k, 38.4k, 57.6 k bps
Communication system	Half duplex	
Synchronization	Asynchronous	
Startup system	One-sided startup using the host side command	
Transmission system	Serial transmission (bit serial transmission)	
Transmission code	ASCII	
Transmission code configuration	7-bit data, 1 start, 1 stop, even parity	
Transmission code outgoing sequence	Sent out from the lowest bit in character units	
Error control	Vertical parity check, checksum, overrun check, framing check	
Transmission unit	Message unit (variable length)	
Maximum message length	503 bytes (including control characters)	
Control procedure	H-series dedicated procedure (HIProtocol) Standard protocol (transmission control procedure 1), Simplified protocol (transmission control procedure 2)	

### Modem control function

Setting the serial port to Passive-HIProtocol enables modem connection. When a modem is connected, calls are automatically received from line when detected, and then the slave function of the task code operates. This function is called modem control function.

Connection may be difficult when using two modems with a significant difference in communication speed. Use models with the same communication speed.

#### (1) Modem connection configuration

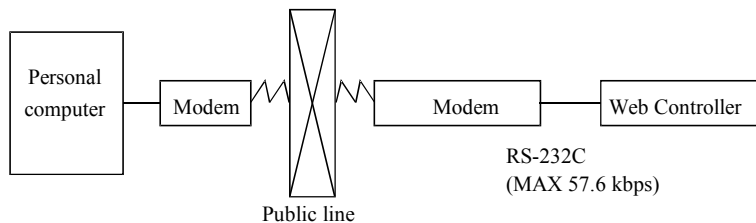

Figure 10.11 Modem connection configuration diagram

Table 10.5 List of serial port signals when a modem is connected

Pin No.	Signal Code	Direction		Meaning
		CPU	Modem	
1]	SG1	←	←	Signal Ground
2]	CD1	←	←	Carrier receive in-progress notification signal Connected to CD in the modem
3]	ER1	→	→	Terminal communication enabled signal
4]	ER2	→	→	Not in use
5]	SD1	→	→	Data sent by CPU Connected to SD in the modem
6]	RD1	←	←	Data received by CPU Connected to RD in the modem
7]	DR1	←	←	Modem communication enabled signal Connected to DR in the modem
8]	RS1	→	→	Transmission request signal Connected to RS in the modem

(2) AT commands

AT commands are used to make various modem settings, and are set from the host computer. Web Controller issues AT commands automatically for initial setting. AT commands are used only for the purpose. Refer to instruction manuals or other documents furnished by modem manufacturers for details on the AT commands. In AT commands, an instruction sent to a modem from the host is called “command,” and the character string in response to the “command” returned to the host from the modem is called “result code.” AT commands always begin with the character string “AT,” and a return code is input at the end of the command. However, A/ is an exception. Commands that follow “AT” can have multiple inputs in a single line.

Example;

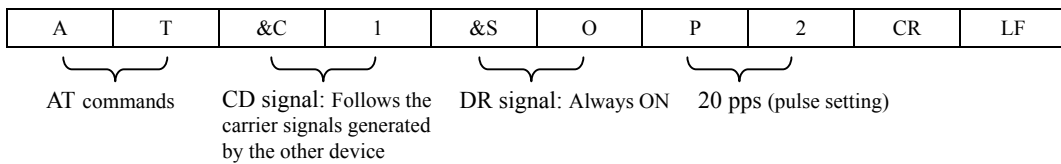

1] Format

a) AT command format

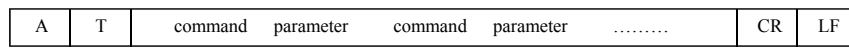

b) Result code format

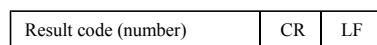
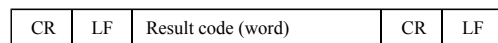

## 2] List of commands (extract)

## a) AT commands

Command	Function overview		Example
AT	Automatically recognizes data format		-
A/	Re-executes the response directly preceding		-
ATA	Forced reception		
ATDmm	Dial		ATD12345678
ATEn	Command echo (echo back a text string entered to a modem)	0: No 1: Yes	ATE0
ATHn	Line ON/OFF	0: On hook (disconnect) 1: Off hook	ATH0 ATH1
ATPn	Pulse (dial) setting	0,1:10 pps 2:20 pps	ATP0, ATP1 ATP2
ATQn	Result code setting	0: Yes 1: No	ATQ0
ATT	Tone (push) setting		ATT
ATSn=X	Sets S register value		ATS0=0
ATVn	Result code display format	0: Number 1: Word	ATV0 ATV1
AT&Cn	CD signal control	0: Always ON 1: Depends on the carrier of the counter-party modem	AT&C0 AT&C1
AT&Dn	ER signal control	0: Always ON 2: Turning from ON to OFF during communication disconnects line 3: Turning from ON to OFF resets the software	AT&D0 AT&D2 AT&D3
AT&Sn	DR signal	0: Always ON 1: Depends on sequence 2: Depends on CD signal	AT&S0 AT&S1 AT&S2
AT&Rn	RI (CI) signal control	0: Turns on from calling start until communication begins 1: Turns on from calling start until communication ends 2: Turns on/off in synchronization with the call signal	AT&R0 AT&R1 AT&R2

## b) S register

S register	Set value	Function
S0	0 no automatic reception 1 to 255	Setting for automatic reception/reception ring count
S2	0 to 127 (43 [+])	Escape code setting
S3	0 to 127 (13 [CR])	CR code setting
S4	0 to 127 (10 [LF])	LF code setting

## c) Result codes

Number format	Word format	Meaning
0	OK	Normal execution
1	CONNECT	Connection complete
2	RING	Reception detected
3	NO CARRIER	Line disconnected
4	ERROR	Command error
5	CONNECT 1200	1200 bps connection
6	NO DIAL TONE	No dial tone heard
7	BUSY	Busy signal detected
8	NO ANSWER	No tone heard
10	CONNECT 2400	2400 bps connection
11	CONNECT 4800	4800 bps connection
12	CONNECT 9600	9600 bps connection
13	CONNECT 14400	14400 bps connection





# Chapter 11 Network Settings

## 11.1 DNS Client Function

Web Controller is equipped with the DNS client function. It means to send a query about an IP address of a host using a domain name to a DNS server on a network which has data to find IP addresses from the domain name data.

DNS: Domain Name System

To use the DNS client function, settings of a DNS server should be made in the IP address configuration screen in the MWConfig page.

With this function, mail servers can be specified using their domain names.

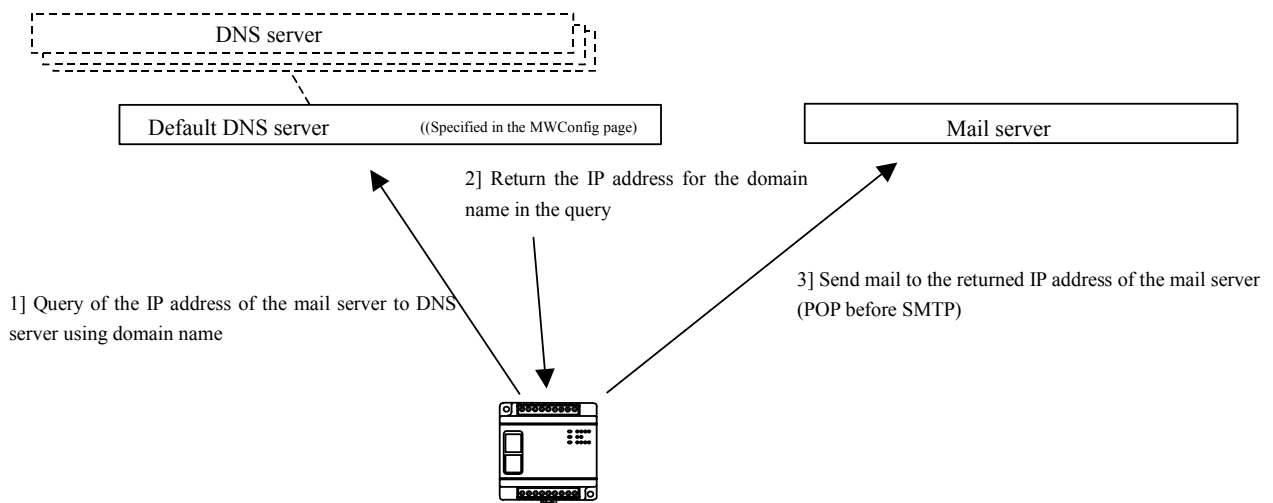

Figure 11.1 Mail sending operation when mail servers are specified with domain names

### **⚠ Caution!!**

When you make “Use DNS” setting, make sure to specify mail servers using domain names. With this setting, IP addresses cannot be used.

## 11.2 Current Time Retrieval Function

Web Controller is equipped with SNTP (Simple Network Time Protocol) client function which retrieves the current time from the NTP server or SNTP server on a network.

The interval of retrievals can be set by specifying time and minute.

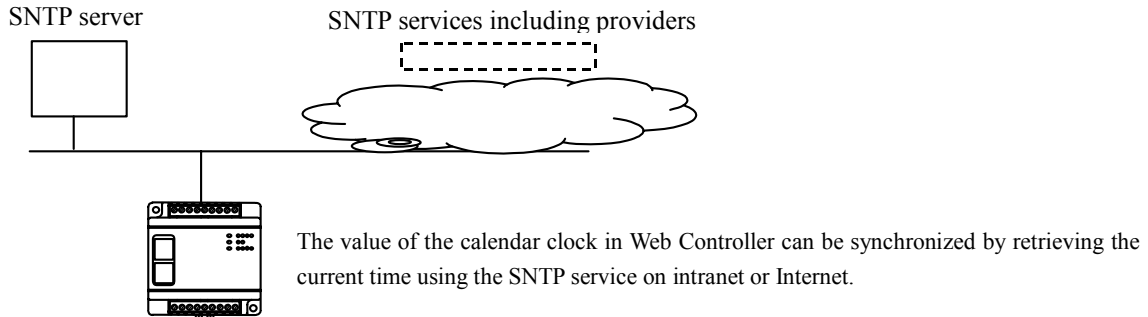

Figure 11.2 Current Time Retrieval Function

Table 11.1 Specifications of Current Time Retrieval Function

Item	Specifications
Communication Protocol	SNTP(Simple Network Time Protocol):
Retrieval Interval	Specified by users (00:00 - 99:99)
Retrieved Time Data	yyyy/mm/dd/tt/mm/ss
Where the time data is stored	Special internal output area (WRF01B - WRF01F)
Update of clock using retrieved time	Update by software in Web Controller

The current time retrieved with this function is stored on the Calendar Clock Area in the special internal output area of Web Controller, and update is made in the specified interval. Between the specified intervals, software in Web Controller updates the time. The update of time using software has the accuracy of plus minus 7 minutes a day. To maintain the accuracy of the calendar clock in Web Controller, we recommend users to set the retrieval interval to a short cycle, e.g. one hour.

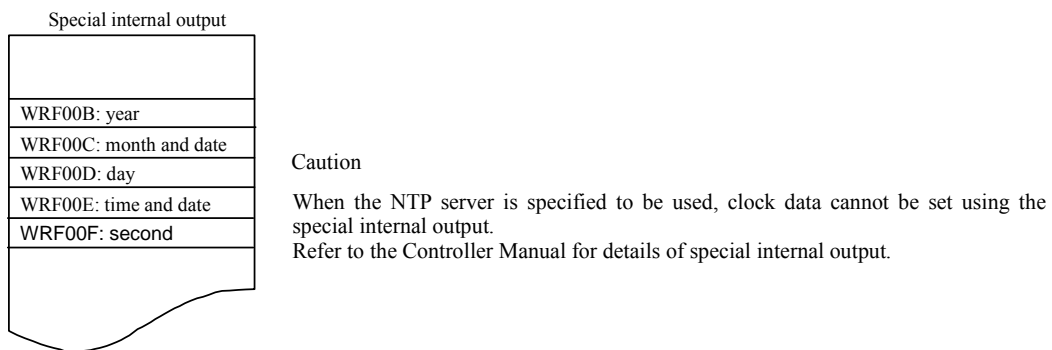

Figure 11.3 Calendar Clock Area

## 11.3 SNMP (Simple Network Management Protocol)

SNMP is a protocol for collecting structure information and/or error status or router or HUB on TCP/IP base network system. There are manager who is management side and agent who is managed side in network management system. SNMP is a protocol communicating MIB (Management Information Base) between manager and agent. This protocol uses UDP/IP and port number 161 is used. Web Controller is an agent and reply MIB according the request from manager.

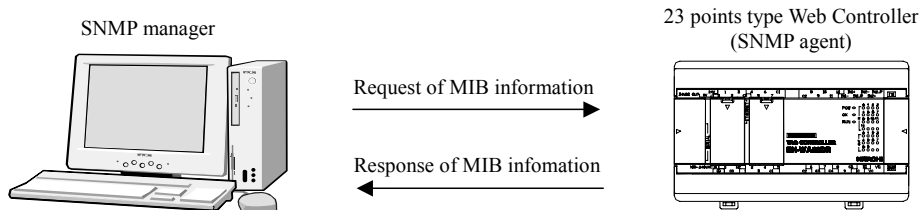

Figure 11.4 SNMP manager and agent

### (1) Supported SNMP Ver.

Web Controller supports SNMP Ver.1 agent function. (Trap function reporting the status from Web Controller to SNMP manager is not supported.)

### (2) Registration of Community name

Community name has a function like password of communication between manager and agent. It is required correct community name when a request is issued from manager to agent.

Community name should be set by accessing System Configuration page of Web Controller.

1. Registration of Community name is possible when SNMP is selected at the Community name registration display at the left side menu of System Configuration display.
2. Login at Super User Registration is needed to access community name registration display.
3. Up to five community names can be registered.
4. Not use, read-only or read-write setting can be done for each community name.
5. Up to 64 characters including large or small characters and figure can be used as community name.
6. It is possible to register community name with not use definition.
7. It is not possible to register same community name and it will be error. The characters are not large or small character and figure will be error.
8. This function cannot be used without registering minimum one community name without set not use.
9. All community names are not use as a default setting.

## (3) Supported MIB

Supported MIB by Web Controller are shown below.

## 1. Supported MIB system diagram

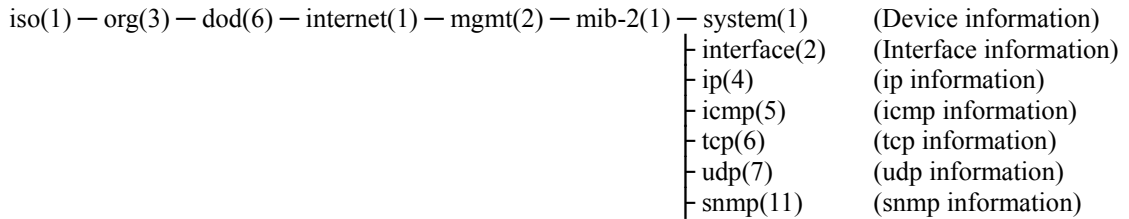

## 2. Supported MIB list

Table 11.2 List of Supported MIB

No	Group/OID	Object Identifier	Descriptions	Initial Value and others
1	system group	Information about devices		
	1.3.6.1.2.1.1.1	sysDescr	A textual description of the entity.	Hitachi Web Controller
	1.3.6.1.2.1.1.2	sysObjectID	The vendor's authoritative identification of the network management subsystem contained in the entity.	0.0.0
	1.3.6.1.2.1.1.3	sysUpTime	The time (in hundredths of a second) since the network management portion of the system was last re-initialized.	0
	1.3.6.1.2.1.1.4	sysContact	The textual identification of the contact person for this managed node, together with information on how to contact this person.	
	1.3.6.1.2.1.1.5	sysName	An administratively-assigned name for this managed node.	
	1.3.6.1.2.1.1.6	sysLocation	The physical location of this node (e.g., 'telephone closet, 3rd floor').	
	1.3.6.1.2.1.1.7	sysServices	A value which indicates the set of services that this primarily offers.	72
2	interface group	Information about Interface		
	1.3.6.1.2.1.2.1	ifNumber	The number of network interfaces (regardless of their current state) present on this system.	1
	1.3.6.1.2.1.2.2	ifTable	A list of interface entries.	
	1.3.6.1.2.1.2.2.1	ifEntry	An interface entry containing objects at the subnetwork layer and below for a particular interface.	
	1.3.6.1.2.1.2.2.1.1	ifIndex	A unique value for each interface. Its value ranges between 1 and the value of ifNumber.	1
	1.3.6.1.2.1.2.2.1.2	ifDescr	A textual string containing information about the interface.	eth0
	1.3.6.1.2.1.2.2.1.3	ifType	The type of interface, distinguished according to the physical / link protocol (s) immediately 'below' the network layer in the protocol stack.	ethernet-csmacd(6)
	1.3.6.1.2.1.2.2.1.4	ifMtu	The size of the largest datagram which can be sent/received on the interface, specified in octets.	1500

Table 11.3 List of Support MIB (continued)

No	Group/OID	Object Identifier	Descriptions	Initial value and others
2	1.3.6.1.2.1.2.2.1.5	ifSpeed	An estimate of the interface's current bandwidth in bits per second.	10000000
	1.3.6.1.2.1.2.2.1.6	ifPhysAddress	The interface's address at the protocol layer immediately 'below' the network layer in the protocol stack.	MAC address on Web Controller.
	1.3.6.1.2.1.2.2.1.7	ifAdminStatus	The desired state of the interface.	UP (1)
	1.3.6.1.2.1.2.2.1.8	ifOperStatus	The current operational state of the interface.	UP (1)
	1.3.6.1.2.1.2.2.1.9	ifLastChange	The value of sysUpTime at the time the interface entered its current operational state.	0
	1.3.6.1.2.1.2.2.1.10	ifInOctets	The total number of octets received on the interface, including framing characters.	0
	1.3.6.1.2.1.2.2.1.11	ifInUcastPkts	The number of subnetwork-unicast packets delivered to a higher-layer protocol.	0
	1.3.6.1.2.1.2.2.1.12	ifInNUcastPkts	The number of non-unicast (i.e., subnetwork-broadcast or subnetwork-multicast) packets delivered to a higher-layer protocol.	0
	1.3.6.1.2.1.2.2.1.13	ifInDiscards	The number of inbound packets which were chosen to be discarded even though no errors had been detected to prevent their being deliverable to a higher-layer protocol.	0
	1.3.6.1.2.1.2.2.1.14	ifInErrors	The number of inbound packets that contained errors preventing them from being deliverable to a higher-layer protocol.	0
	1.3.6.1.2.1.2.2.1.15	ifInUnknownProtos	The number of packets received via the interface which were discarded because of an unknown or unsupported protocol.	0
	1.3.6.1.2.1.2.2.1.16	ifOutOctets	The total number of octets transmitted out of the interface, including framing characters.	0
	1.3.6.1.2.1.2.2.1.17	ifOutUcastPkts	The total number of packets that higher-level protocols requested be transmitted to a subnetwork-unicast address, including those that were discarded or not sent.	0
	1.3.6.1.2.1.2.2.1.18	ifOutNUcastPkts	The total number of packets that higher-level protocols requested be transmitted to a non-unicast (i.e., a subnetwork-broadcast or subnetwork-multicast) address, including those that were discarded or not sent.	0
	1.3.6.1.2.1.2.2.1.19	ifOutDiscards	The number of outbound packets which were chosen.	0
	1.3.6.1.2.1.2.2.1.20	ifOutErrors	The number of outbound packets that could not be transmitted because of errors.	0
	1.3.6.1.2.1.2.2.1.21	ifOutQLen	The length of the output packet queue (in packets).	16
1.3.6.1.2.1.2.2.1.22	ifSpecific	A reference to MID definitions specific to be particular media being used to realize the interface.	(0.0.0)	

Table 11.4 List of Support MIB (continued)

No.	Group/OID	Object Identifier	Descriptions	Initial value and others
3	ip group	IP information		
	1.3.6.1.2.1.4.1	ipForwarding	The indication of whether this entity is acting as an IP gateway in respect to the forwarding of datagrams received by, but not addressed to, this entity.	Not-forwarding (2)
	1.3.6.1.2.1.4.2	ipDefaultTTL	The default value inserted into the Time-To-Live field of the IP header of datagrams originated at this entity, whenever a TTL value is not supplied by the transport layer protocol.	32
	1.3.6.1.2.1.4.3	ipInReceives	The total of input datagrams received from interfaces, including those received in error.	0
	1.3.6.1.2.1.4.4	ipInHdrErrors	The number of input datagrams discarded due to errors in their IP headers, including bad checksums, version number mismatch, other format error, time-to-live exceeded, errors discovered in processing their IP options, etc.	0
	1.3.6.1.2.1.4.5	ipInAddrErrors	The number of input datagrams discarded because the IP address in their IP header's destination field was not a valid address to be received at this entity.	0
	*1.3.6.1.2.1.4.6	ipForwDatagrams	The number of input datagrams for which this entity was not their final IP destinations, as a result of which an attempt was made to find a route to forward them to that final destination.	0
	1.3.6.1.2.1.4.7	ipInUnknownProtos	The number of locally0addressed datagrams received successfully but discarded because of an unknown or unsupported protocol.	0
	*1.3.6.1.2.1.4.8	ipInDiscards	The number of input IP datagrams for which no problems were encountered to prevent their continued processing, but which were discarded (e.g., for lack of buffer space).	0
	1.3.6.1.2.1.4.9	ipInDelivers	The total number of input datagrams successfully delivered to IP user-protocols (including ICM).	0
	1.3.6.1.2.1.4.10	ipOutRequests	The total number of IP datagrams which local IP user-protocols (including ICMP) supplied to IP in requests for transmission.	0
	*1.3.6.1.2.1.4.11	ipOutDiscards	The number of output IP datagrams for which no problem was encountered to prevent their transmission to their destination, but which were discarded (e.g., for lack of buffer space).	0
	*1.3.6.1.2.1.4.12	ipOutNoRoutes	The number of IP datagrams discarded because no route could be found to transmit them to their destination.	0
*1.3.6.1.2.1.4.13	ipReasmTimeout	The maximum number of seconds which received fragments are held while they are awaiting reassembly as this entity.	2	

As for the object marked with \*, information is not updated.

Table 11.5 List of Support MIB (continued)

No	Group/OID	Object Identifier	Descriptions	Initial value and others
3	*1.3.6.1.2.1.4.14	ipReasmReqds	The number of IP fragments received which needed to be reassembled at this entity.	0
	*1.3.6.1.2.1.4.15	ipReasmOKs	The number of IP datagrams successfully reassembled.	0
	*1.3.6.1.2.1.4.16	ipReasmFails	The number of failures detected by the IP reassembly algorithm (for whatever reason: timed out, errors, etc).	0
	*1.3.6.1.2.1.4.17	ipFragOKs	The number of IP datagrams that have been successfully fragmented at this entity.	0
	*1.3.6.1.2.1.4.18	ipFragFails	The number of IP datagrams that have been discarded because they needed to be fragmented at this entity but could not be, e.g., because their Don't Fragment flag was set.	0
	*1.3.6.1.2.1.4.19	ipFragCreates	The number of IP datagram fragments that have been generated as a result of fragmentation at this entity.	0
	1.3.6.1.2.1.4.20	ipAddrTable	The table of addressing information relevant to this entity's IP addresses.	
	1.3.6.1.2.1.4.20.1	ipAddrEntry	The addressing information for one of this entity's IP addresses.	
	1.3.6.1.2.1.4.20.1.1	ipAdEntAddr	The IP address to which this entry's addressing information pertains.	192.168.0.1
	1.3.6.1.2.1.4.20.1.2	ipAdEntIfIndex	The index value which uniquely identifies the interface to which this entry is applicable.	1
	1.3.6.1.2.1.4.20.1.3	ipAdEntNetMask	The subnet mask associated with the IP address of this entry.	255.255.255.0
	1.3.6.1.2.1.4.20.1.4	ipAdEntBcastAddr	The value of the least-significant nit in the IP broadcast address used for sending datagrams on the (logical) interface associated with the IP address of this entry.	1
	1.3.6.1.2.1.4.20.1.5	ipAdEntReasmMaxSize	The size of the largest IP datagram which this entity can re-assemble from incoming IP fragmented datagrams received on this interface.	1500
	1.3.6.1.2.1.4.22	ipNetToMediaTable	The IP Address Translation table used for mapping from IP addresses to physical addresses.	
	1.3.6.1.2.1.4.22.1	ipNetToMediaEntry	Each entry contains one IpAddress to 'physical' address equivalence.	
	1.3.6.1.2.1.4.22.1.1	ipNetToMediaIfIndex	The interface on which this entry's equivalence is effective.	
	1.3.6.1.2.1.4.22.1.2	ipNetToMediaPhysAddress	The media-dependent 'physical' address.	
	1.3.6.1.2.1.4.22.1.3	ipNetToMediaNetAddress	The IpAddress corresponding to the media-dependent 'physical' address.	
	1.3.6.1.2.1.4.22.1.4	ipNetToMediaType	The type of mapping.	
	*1.3.6.1.2.1.4.23	ipRoutingDiscards	The number of routing entries which were chosen to be discarded even though they are valid.	0

As for the object marked with \*, information is not updated.



Table 11.6 List of Support MIB (continued)

No	Group/OID	Object Identifier	Descriptions	Initial value and others
4	Icmp group	ICMP information		
	1.3.6.1.2.1.5.1	icmpInMsgs	The total number of ICMP message which the entity received.	0
	1.3.6.1.2.1.5.2	icmpInErrors	The number of ICMP messages which the entity received but determined as having ICMP-specific errors (bad ICMP checksums, bad length, etc.).	0
	*1.3.6.1.2.1.5.3	icmpInDestUnreachs	The number of ICMP Destination Unreachable messages received.	0
	*1.3.6.1.2.1.5.4	icmpInTimeExcds	The number of ICMP Time Exceeded messages received.	0
	*1.3.6.1.2.1.5.5	icmpInParmProbs	The number of ICMP Parameter Problem messages received.	0
	*1.3.6.1.2.1.5.6	icmpInSrcQuenchs	The number of ICMP Source Quench messages received.	0
	*1.3.6.1.2.1.5.7	icmpInRedirects	The number of ICMP Redirect messages received.	0
	1.3.6.1.2.1.5.8	icmpInEchos	The number of ICMP Echo (request) messages received.	0
	1.3.6.1.2.1.5.9	icmpInEchoReps	The number of ICMP Echo Reply messages received.	0
	*1.3.6.1.2.1.5.10	icmpInTimestamps	The number of ICMP Timestamp (request) messages received.	0
	*1.3.6.1.2.1.5.11	icmpInTimestampReps	The number of ICMP Timestamp Reply messages received.	0
	*1.3.6.1.2.1.5.12	icmpInAddrMasks	The number of ICMP Address Mask Request messages received.	0
	*1.3.6.1.2.1.5.13	icmpInAddrMaskReps	The number of ICMP Address Mask Reply messages received.	0
	1.3.6.1.2.1.5.14	icmpOutMsgs	The total number of ICMP messages which this entity attempted to send.	0
	1.3.6.1.2.1.5.15	icmpOutErrors	The number of ICMP messages which this entity did not send due to problems discovered within ICMP> such as a lack of buffers.	0
	*1.3.6.1.2.1.5.16	icmpOutDestUnreachs	The number of ICMP Destination Unreachable messages sent.	0
	*1.3.6.1.2.1.5.17	icmpOutTimeExcds	The number of ICMP Time Exceeded messages sent.	0
	*1.3.6.1.2.1.5.18	icmpOutParmProbs	The number of ICMP Parameter Problem messages sent.	0
	*1.3.6.1.2.1.5.19	icmpOutSrcQuenchs	The number of ICMP Source Quench messages sent.	0
	*1.3.6.1.2.1.5.20	icmpOutRedirects	The number of ICMP Redirect messages sent.	0
	1.3.6.1.2.1.5.21	icmpOutEchos	The number of ICMP Echo (request) messages sent.	0
	1.3.6.1.2.1.5.22	icmpOutEchoReps	The number of ICMP Echo Reply messages sent.	0
	*1.3.6.1.2.1.5.23	icmpOutTimestamps	The number of ICMP Timestamp (request) messages sent.	0
	*1.3.6.1.2.1.5.24	icmpOutTimestampReps	The number of ICMP Timestamp Reply messages sent.	0
	*1.3.6.1.2.1.5.25	icmpOutAddrMasks	The number of ICMP Address Mask Request messages sent.	0
*1.3.6.1.2.1.5.26	icmpOutAddrMaskReps	The number of ICMP Address Mask Reply messages sent.	0	

As for the object marked with \*, information is not updated.

Table 11.7 List of Support MIB (continued)

No	Group/OID	Object Identifier	Descriptions	Initial value and others
5	tcp group	TCP information		
	1.3.6.1.2.1.6.1	tcpRtoAlgorithm	The algorithm used to determine the timeout value used for retransmitting unacknowledged octets.	vanj(4)
	1.3.6.1.2.1.6.2	tcpRtoMin	The minimum value permitted by a TCP implementation for the retransmission timeout, measured in milliseconds.	300
	1.3.6.1.2.1.6.3	tcpRtoMax	The maximum value permitted by TCP implementation for the retransmission timeout, measured in milliseconds.	64000
	1.3.6.1.2.1.6.4	tcpMaxConn	The limit of the total number of TCP connections the entity can support.	22
	1.3.6.1.2.1.6.5	tcpActiveOpens	The number of times TCP connections have made a direct transition to the SYN-SENT state from the CLOSED state.	0
	1.3.6.1.2.1.6.6	tcpPassiveOpens	The number of times TCP connections have made a direct transition to the SYN-RCVD state from the LISTEN state.	0
	1.3.6.1.2.1.6.7	tcpAttemptFails	The number of times TCP connections have made a direct transition to the CLOSED state from either the SYN-SENT state or the SYN-RCVD state, plus the number of times TCP connections have made a direct transition to the LISTEN state from the SYN-RCVD state.	0
	1.3.6.1.2.1.6.8	tcpEstabResets	The number of times TCP connections have made a direct transition to the CLOSED state from either the ESTABLISHED state or the CLOSE-WAIT state.	0
	1.3.6.1.2.1.6.9	tcpCurrEstab	The number of TCP connections for which the current state is either ESTABLISHED or CLOSE-WAIT.	0
	1.3.6.1.2.1.6.10	tcpInSegs	The total number of segments received, including those received in error.	0
	1.3.6.1.2.1.6.11	tcpOutSegs	The total number of segments sent, including those on current connections but excluding those containing only retransmitted octets.	0
	1.3.6.1.2.1.6.12	tcpRetransSegs	The total number of segments retransmitted – that is, the number of TCP segments transmitted containing one of more previously transmitted octets.	0
	1.3.6.1.2.1.6.13	tcpConnTable	A table containing TCP connection-specific information.	
	1.3.6.1.2.1.6.13.1	tcpConnEntry	Information about a particular current TCP connection.	
	1.3.6.1.2.1.6.13.1.1	tcpConnState	The state of this TCP connection.	
	1.3.6.1.2.1.6.13.1.2	tcpConnLocalAddress	The local IP address for this TCP connection.	
1.3.6.1.2.1.6.13.1.3	tcpConnLocalPort	The local port number for this TCP connection.		
1.3.6.1.2.1.6.13.1.4	tcpConnRemAddress	The remote IP address for this TCP connection.		

Table 11.8 List of Support MIB (continued)

No	Group/OID	Object Identifier	Descriptions	Initial value and others
5	1.3.6.1.2.1.6.13.1.5	tcpConnRemPort	The remote port number for this TCP connection.	
	1.3.6.1.2.1.6.14	tcpInErrs	The total number of segments received in error (e.g., bad TCP checksums).	0
	1.3.6.1.2.1.6.15	tcpOutRsts	The number of TCP segments sent containing the RST flag.	0
6	udp group	UDP information		
	1.3.6.1.2.1.7.1	udpInDatagrams	The total number of UDP datagrams delivered to UDP users.	0
	1.3.6.1.2.1.7.2	udpNoPorts	The total number of received UDP datagrams for which there was no application at the destination port.	0
	1.3.6.1.2.1.7.3	udpInErrors	The number of received UDP datagrams that could not be delivered for reasons other than the lack of an application at the destination port.	0
	1.3.6.1.2.1.7.4	udpOutDatagrams	The total number of UDP datagrams sent from this entity.	0
	1.3.6.1.2.1.7.5	udpTable	A table containing UDP listener information.	
	1.3.6.1.2.1.7.5.1	udpEntry	Information about a particular current UDP listener.	
	1.3.6.1.2.1.7.5.1.1	udpLocalAddress	The local IP address for this UDP listener.	
	1.3.6.1.2.1.7.5.1.2	udpLocalPort	The local port number of this UDP listener.	
7	snmp group	SNMP information		
	1.3.6.1.2.1.11.1	snmpInPkts	The total number of Messages delivered to the SNMP entity from the transport service.	0
	1.3.6.1.2.1.11.2	snmpOutPkts	The total number of SNMP Messages which were passed from the SNMP protocol entity to the transport service.	0
	1.3.6.1.2.1.11.3	snmpInBadVersions	The total number of SNMP Messages which were delivered to the SNMP protocol entity and were for an unsupported SNMP version.	0
	1.3.6.1.2.1.11.4	snmpInBadCommunityNames	The total number of SNMP Messages delivered to the SNMP protocol entity which used a SNMP community name not known to said entity.	0
	1.3.6.1.2.1.11.5	snmpInBadCommunityUses	The total number of SNMP Messages delivered to the SNMP protocol entity which represented an SNMP operation which was not allowed by the SNMP community named in the Message.	0
	1.3.6.1.2.1.11.6	snmpInASNParseErrs	The total number of ASN.1 or BER errors encountered by the SNMP protocol entity when decoding received SNMP Messages.	0
	1.3.6.1.2.1.11.8	snmpInTooBigs	The total number of SNMP PDUs which were delivered to the SNMP protocol entity and for which the value of the error-status field is 'tooBig'.	0

Table 11.9 List of Support MIB (continued)

No	Group/OID	Object Identifier	Descriptions	Initial value and others
7	1.3.6.1.2.1.11.9	snmpInNoSuchNames	The total number of SNMP PDUs which were delivered to the SNMP protocol entity and for which the value of the error-status field is 'noSuchName'.	0
	1.3.6.1.2.1.11.10	snmpInBadValues	The total number of SNMP PDUs which were delivered to the SNMP protocol entity and for which the value of the error-status field is 'badValue'.	0
	1.3.6.1.2.1.11.11	snmpInReadOnlys	The total number valid SNMP PDUs which were delivered to the SNMP protocol entity and for which the value of the error-status field is 'readOnly'.	0
	*1.3.6.1.2.1.11.12	snmpInGenErrs	The total number of SNMP PDUs which were delivered to the SNMP protocol entity and for which the value of the error-status field is 'genErr'.	0
	1.3.6.1.2.1.11.13	snmpInTotalReqVars	The total number of MIC objects which have been retrieved successfully by the SNMP protocol entity as the result of receiving valid SNMP Get-Request and Get-Next PDUs.	0
	1.3.6.1.2.1.11.14	snmpInTotalSetVars	The total number of MIC objects which have been altered successfully by the SNMP protocol entity as the result of receiving valid SNMP Set-Request PDUs.	0
	1.3.6.1.2.1.11.15	snmpInGetRequests	The total number of SNMP Get-Request PDUs which have been accepted and processed by the SNMP protocol entity.	0
	1.3.6.1.2.1.11.16	snmpInGetNexts	The total number of SNMP Get-Next PIDs which have been accepted and proceed by the SNMP protocol entity.	0
	1.3.6.1.2.1.11.17	snmpInSetRequests	The total number of SNMP Set-Request PDUs which have been accepted and processed by the SNMP protocol entity.	0
	*1.3.6.1.2.1.11.18	snmpInGetResponses	The total number of SNMP Get-Response PDUs which have been accepted and processed by the SNMP protocol entity.	0
	*1.3.6.1.2.1.11.19	snmpInTraps	The total number of SNMP Trap PDUs which have been accepted and processed by the SNMP protocol entity.	0
	*1.3.6.1.2.1.11.20	snmpOutTooBigs	The total number of SNMP PDUs which were generated by the SNMP protocol entity and for which the value of the error-status field is 'tooBig'.	0
	*1.3.6.1.2.1.11.21	snmpOutNoSuchNames	The total number of SNMP PDUs which were generated by the SNMP protocol entity and for which the value of the error-status is 'noSuchName'.	0

As for the object marked with \*, information is not updated.

Table 11.10 List of Support MIB (continued)

No	Group/OID	Object Identifier	Descriptions	Initial value and others
7	*1.3.6.1.2.1.11.22	snmpOutBadValues	The total number of SNMP PDUs which were generated by the SNMP protocol entity and for which the value of the error-status field is 'badValue'.	0
	*1.3.6.1.2.1.11.24	snmpOutGenErrs	The total number of SNMP PDUs which were generated by the SNMP protocol entity and for which the value of the error-status field is 'genErr'.	0
	*1.3.6.1.2.1.11.25	snmpOutGetRequests	The total number of SNMP Get-Request PDUs which have been generated by the SNMP protocol entity.	0
	*1.3.6.1.2.1.11.26	snmpOutGetNexts	The total number of SNMP Get-Next PDUs which have been generated by the SNMP protocol entity.	0
	*1.3.6.1.2.1.11.27	snmpOutSetRequests	The total number of SNMP Set-Request PDUs which have been generated by the SNMP protocol entity.	0
	1.3.6.1.2.1.11.28	snmpOutGetResponses	The total number of SNMP Get-Response PDUs which have been generated by the SNMP protocol entity.	0
	1.3.6.1.2.1.11.29	snmpOutTraps	The total number of SNMP Trap PDUS which have been generated by the SNMP protocol entity.	0
	*1.3.6.1.2.1.11.30	snmpEnableAuthenTraps	Indicates whether the SNMP agent process is permitted to generate authentication-failure traps.	2

As for the object marked with \*, information is not updated.

# Chapter 12 Super User Registration

Super Users, who is authorized to configure Web Controller, should be registered. It is possible to register four Super Users. Their IDs and passwords are specified using 1 up to 16 one byte characters (upper and lower cases) or numeric. Authorization (items to be configured by the Super User) to each Super User can be separately specified.

To register and configure Super Users, access the Super User Registration CGI stored in Web Controller. To access the Super User Registration CGI, enter the following URL via a Web browser from a PC after connecting Ethernet ports on Web Controller and a PC using a LAN cable.

Table 12.1 Example of URL statement to access the Super User Registration CGI

1	URL statement	Remarks
	<p data-bbox="300 555 646 582">http://192.168.0.1/systemsetting.cgi</p> <p data-bbox="411 582 885 728">└───┬─── Super User Registration CGI      └─── IP address</p>	<p data-bbox="1072 577 1348 694">When accessing to Super User Registration CGI with the factory default IP address.</p>

## (1) Super User Registration login screen

The following screen is displayed after accessing the URL of Super User Registration CGI. To register and configure Super Users, log in to the Super User Registration function. The user who is authorized to log in to the function is called "System Administrator." To log in to this function, enter the password for System Administrator (initial password: "1111") in the textbox, and click the [SUBMIT] button. Log in to this function after the password for the System Administrator is authenticated.



Figure 12.1 Super User Registration login screen

### ⚠ Caution!!

The initial password for the System Administrator is "1111." Unchanged password means leaving a security hole open. Make sure to change the initial password for System Administrator.

Refer to "12.3 Password Change for System Administrator" to change the password.

(2) Super User Registration screen composition

The following screen is displayed after log in to the Super User Registration CGI. The left part is the “Menu Screen,” and the right part is the “Main Screen.” By clicking the link on the menu screen, corresponding screens will be displayed in the main screen. The followings table describes the contents of the links on the menu screen.

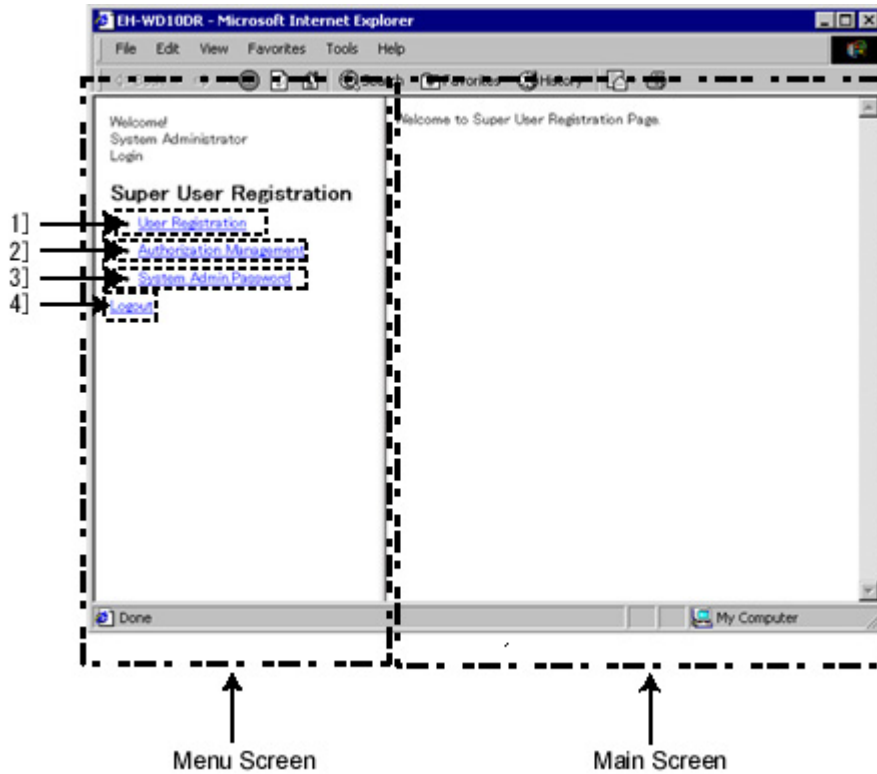

Figure 12.2 Screen composition after log in to the Super User Registration CGI

Table 12.2 Screen information after log in to the Super User Registration CGI

No.	Name	Setting Options
1]	User Registration	Register Super Users.
2]	Authorization Management	Specify the authorization for each Super User.
3]	System Admin.Password	Change the password to log in to Super User Registration.
4]	Logout	Log out from the Super User Registration.

## 12.1 Registration of Super Users

This section describes how to register Super Users. To register Super Users, click [User Registration] from the menu screen. By clicking the link, the following screen will be displayed. Enter the content to be registered, and click the [SET] button. Registration is completed if there is no error on the contents.

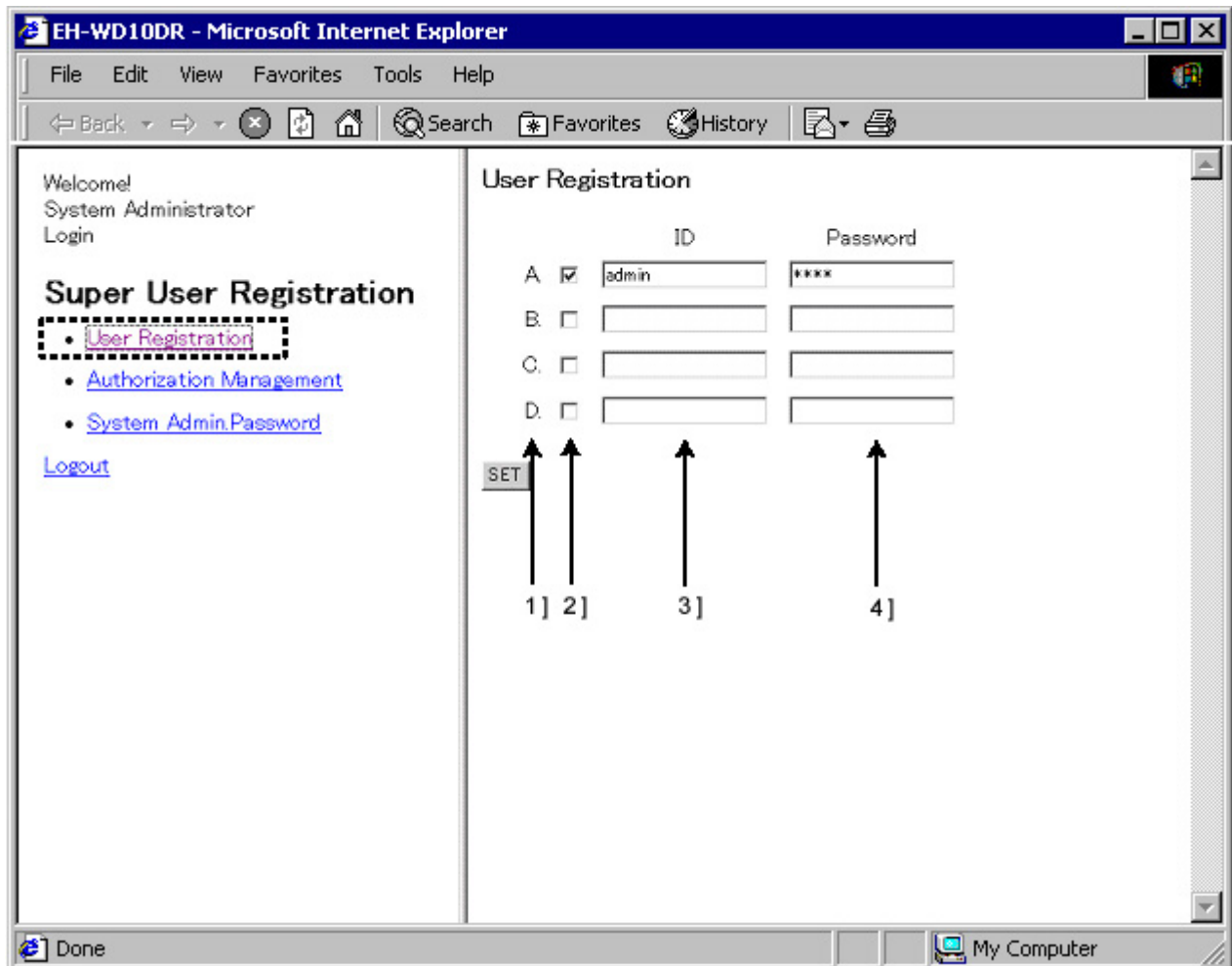

Figure 12.3 Screen composition of User Registration

Table 12.3 Screen information of User Registration

No.	Name	Setting Options
1]	Super User Identification Name	Identification names of Super Users. There are four, which are A, B, C and D. They are used to register the authorization for each user.
2]	Checkbox for Enabling/Disabling Super Users	Check this box to enable registered Super Users. Without checking this box, the ID for this Super User cannot be used even if the ID and Password are registered.
3]	Super User ID	Register Super User IDs. 1 up to 16 one byte characters (upper and lower cases) or numeric can be used.
4]	Super User Password	Specify Super User passwords. 1 up to 16 one byte characters (upper and lower cases) or numeric can be used. Passwords are displayed in “*.”



## 12.2 Configuration of authorization

This section describes how to configure the authorization for Super Users. This function is used to configure items to be set with “System Configuration” function. Refer to “Chapter 13 System Configuration” for System Configuration.

To set the authorization for Super Users, click [Authorization Management] from the menu screen. By clicking the link, the following screen will be displayed. To set the authorization, check the corresponding checkbox and click the [SET] button. On this screen, the checkboxes for Super Users, which are not enabled in [User Registration], are disabled and displayed in gray.

(1) 10 points type

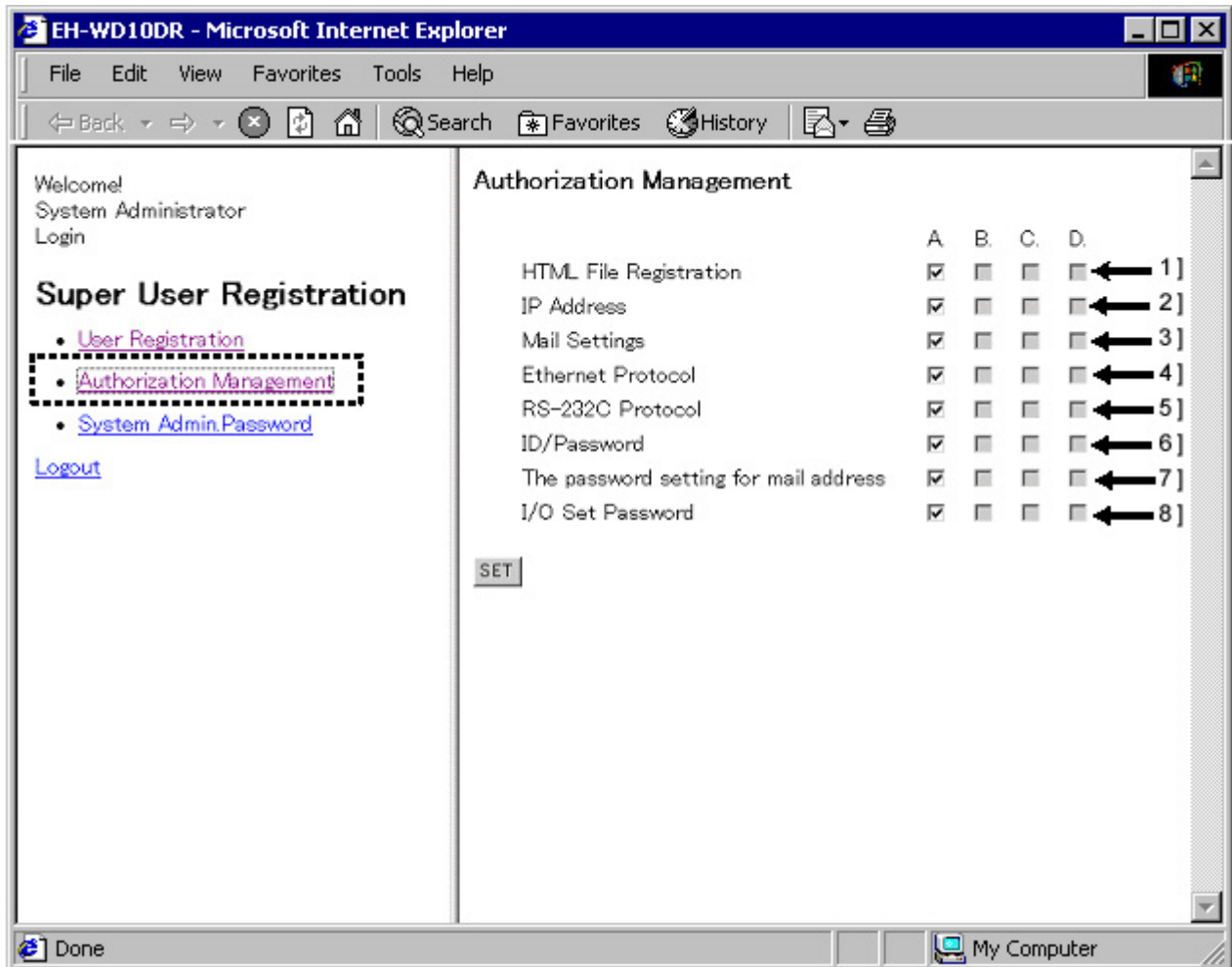

Figure 12.4 Authorization Management screen (10 points type)

(2) 23 points type

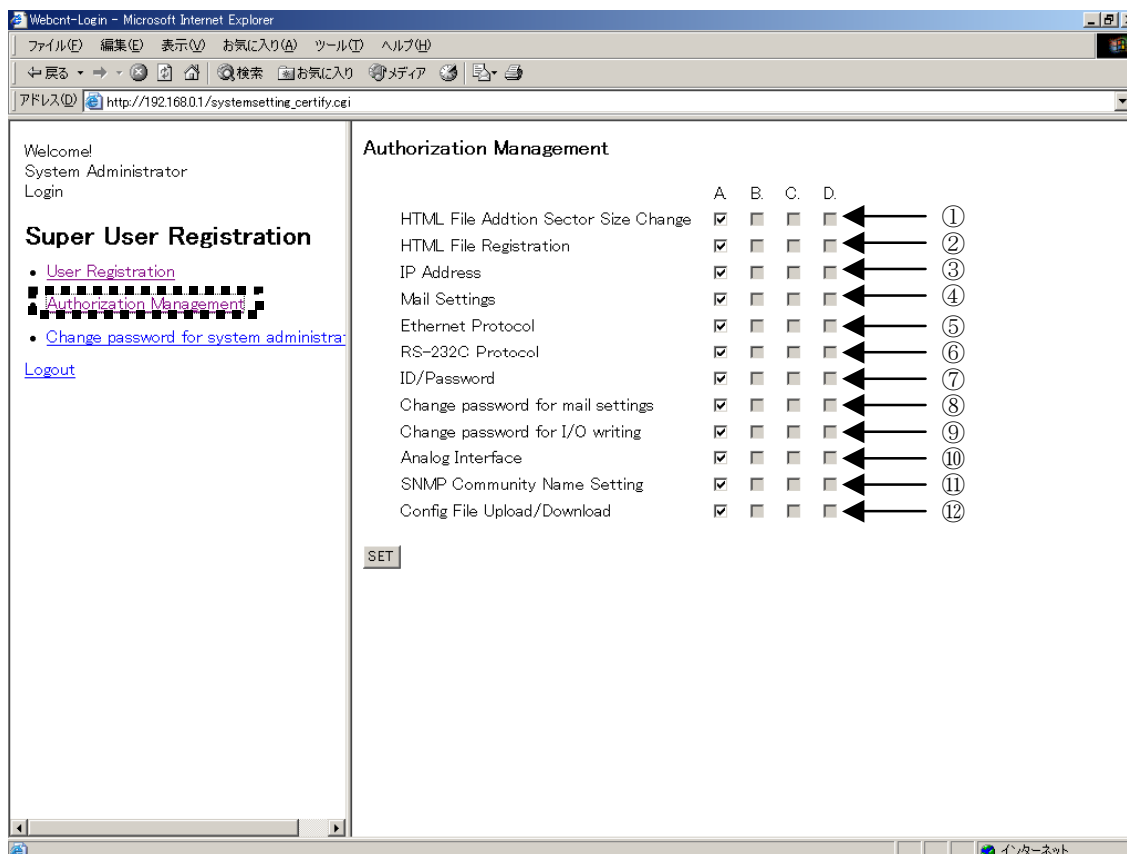

Figure 12.5 Authorization Management screen (23 points type)

Table 12.4 Authorization Management screen

No.	Name	Setting Options	Remarks
1]	HTML File Addition Sector Size Change	Set HTML file registering area size.	*
2]	HTML File Registration	Register, delete and download HTML files.	
3]	IP Address	Set IP addresses, DNS and NTP.	
4]	Mail Settings	Perform e-mail settings.	
5]	Ethernet Protocol	Perform Ethernet settings.	
6]	RS-232C Protocol	Perform serial communication settings.	
7]	ID/Password	Perform ID/Password settings.	
8]	I/O Set Password	Change the password to log in e-mail settings function.	
9]	Changepassword for I/O writing	Change the password for I/O set.	
10]	Analog Interface	Perform analog input/output settings.	*
11]	SNMP Community Name Setting	Perform SNMP settings.	*
12]	Config File Upload/Download	Configuration of Web Controller by using configuration file Upload/Download function.	*

\* These functions are supported by 23 points type only. Therefore, there is setting column in the Authorization Management screen in 10 points type.

## 12.3 Password change for System Administrator

This section describes how to change the password for System Administrator. To change the password for System Administrator, click [System Admin.Password] from the menu screen. By clicking the link, the following screen will be displayed. Enter the content to be changed, and click the [SET] button. Change is completed if there is no error on the contents.

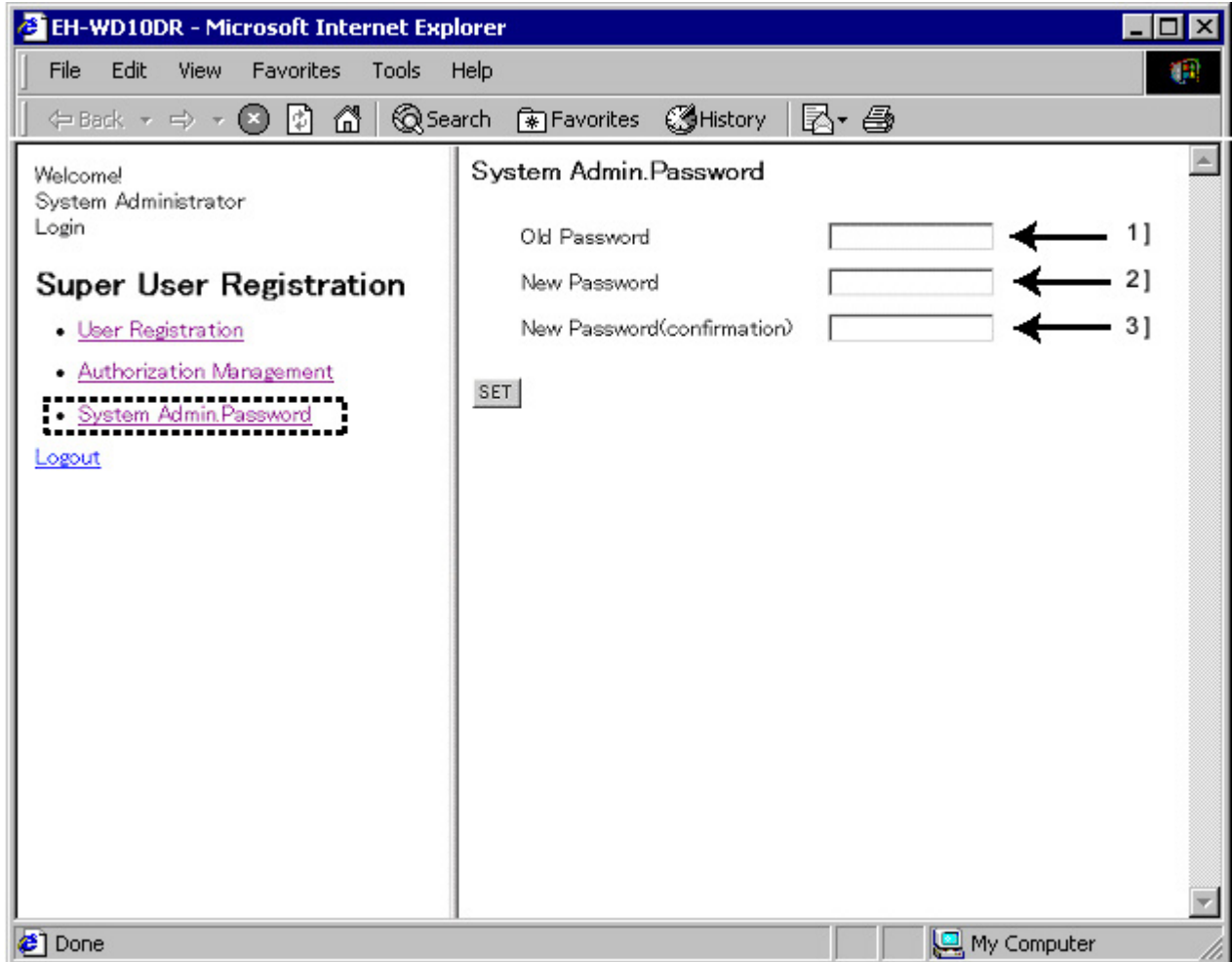

Figure 12.6 Screen composition of System Admin.Password

Table 12.5 Screen information of System Admin.Password

No.	Name	Setting Options
1]	Old Password	Enter the current password for System Administrator.
2]	New Password	Enter the new password for System Administrator. 1 up to 16 one byte characters (upper and lower cases) or numeric can be used for the password.
3]	New Password (confirmation)	Enter the new password for System Administrator again for confirmation.

## 12.4 Remarks

### (1) Access control

Simultaneous access to the Super User Registration page from multiple PCs is not permitted.

Access to the System Configuration page is not permitted during the login to the setting pages to the System Configuration page or mail settings page.

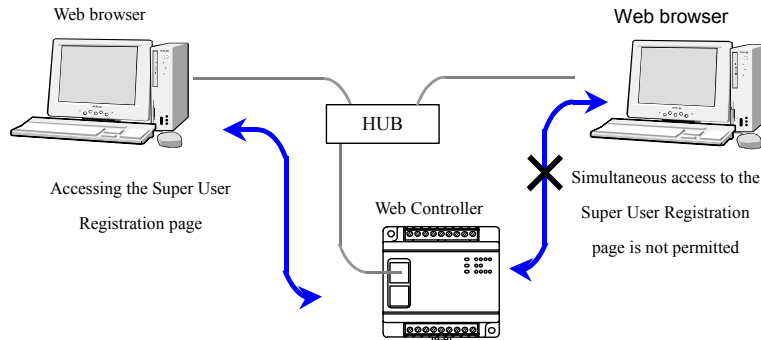

Figure 12.6 Access control

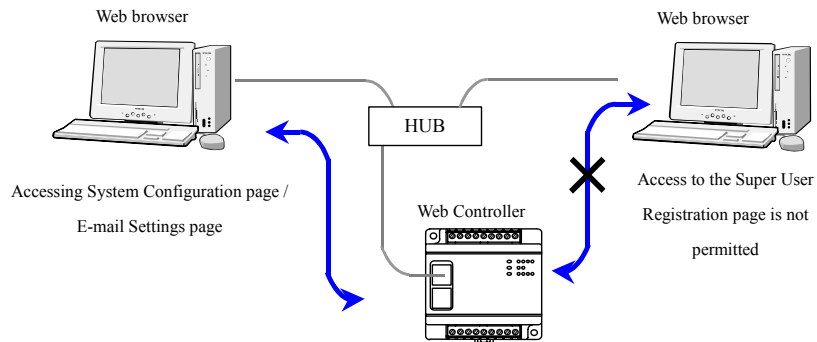

Figure 12.7 Access control

### (2) Access timeout

If no operation is performed for 5 minutes after the login to the Super User Registration page from a Web browser, logout is forced. If this is the case, log in again by entering a password.

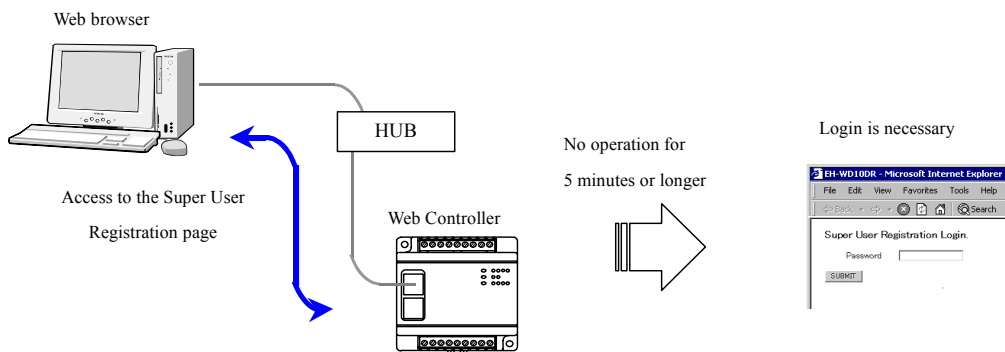

Figure 12.9 Access timeout

***MEMO***

# Chapter 13 System Configuration

Web Controller requires various settings. Only Super Users can perform settings of Web Controller. Refer to “Chapter 12 Super User Registration” for details on Super Users.

To perform various setting, access the System Configuration CGI stored in Web Controller. To access the System Configuration CGI, enter the following URL via a Web browser from a PC after connecting Ethernet ports on Web Controller and a PC using a LAN cable.

Table 13.1 Example of URL statement to access System Configuration CGI

	URL statement	Remarks
1	<p>http://192.168.0.1/mwconfig.cgi</p> <p>└── IP Address</p> <p>└── System Configuration CGI</p>	When accessing to System Configuration CGI with the factory default IP address.

### (1) System Configuration Login screen

The following screen is displayed after accessing the System Configuration CGI. To login to this function, enter a Super User ID and a password registered in the Super User Registration in respective textboxes, and click the [SUBMIT] button. Log in to this function after the ID and password are authenticated.

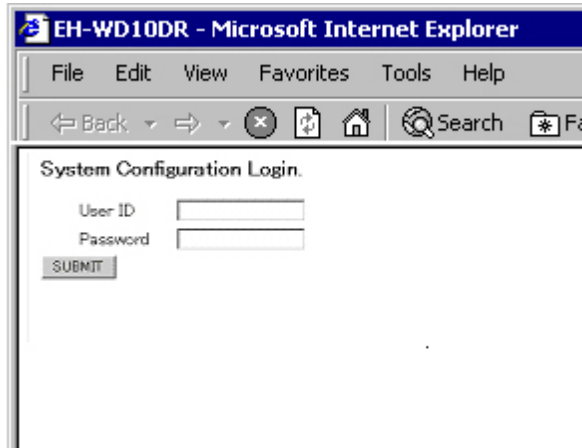

Figure 13.1 System Configuration Login screen

### **⚠ Caution!!**

Initial user ID is “admin” and initial password is “1111” for System Configuration login. Keeping user ID and password in initial setting may become a security hole. Therefore, be sure to change the initial user ID and password into any others.

### 13.1 10 points type (EH-WD10DR)

(1) System Configuration index screen

The following screen is displayed after log in to the System Configuration CGI. (This screen is an example for a Super User authorized for all settings in the Super User Registration.) The left part is the “Menu Screen,” and the right part is the “Main Screen.” By clicking the link on the menu screen, corresponding screens will be displayed. The following table describes the contents of the links on the menu screen. The Menu screen displays only the links authorized for the Super User under the configuration in the Super User Registration.

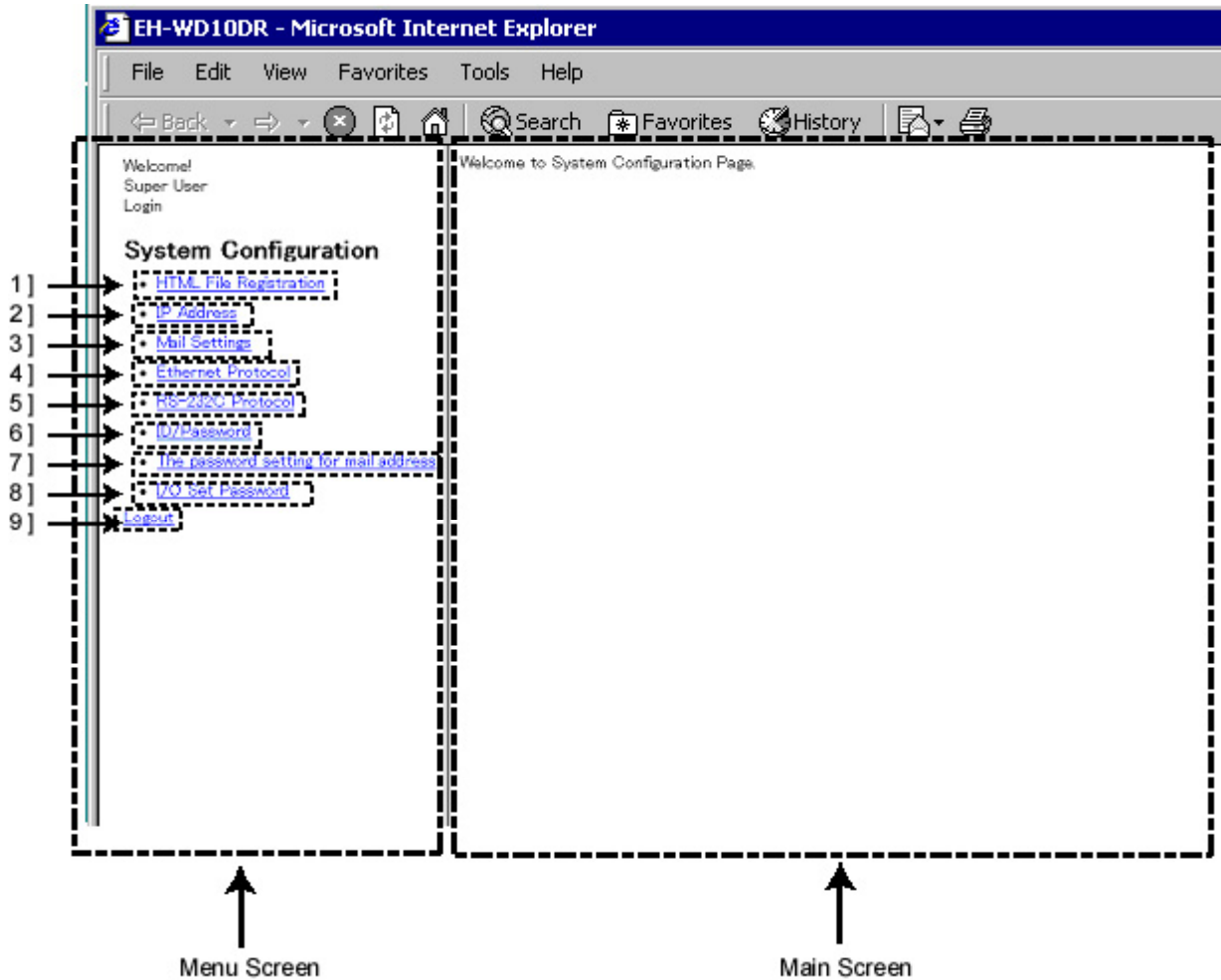

Figure 13.2 System Configuration index screen

Table 13.2 System Configuration index screen

No.	Name	Setting Options
1]	HTML File Registration	Register, delete and download HTML files.
2]	IP Address	Set IP addresses, DNS server and NTP server.
3]	Mail Settings	Perform e-mail settings
4]	Ethernet Protocol	Perform Ethernet Protocol settings
5]	RS-232C Protocol	Perform RS-232C Protocol settings
6]	ID/Password	Perform ID/Password settings
7]	Change password for mail settings	Change the password to log in mail settings function.
8]	Change password for I/O writing	Change the password for I/O set.
9]	Logout	Logout from the System Configuration

## ⚠ Caution!!

The following screen will be displayed when accessing the System Configuration without giving any setting authorization in the Super User Registration. Super Users with no setting authorization is given see this screen. No setting operation can be performed in this screen. Note that the Super User Registration gives no setting authorization as the default.

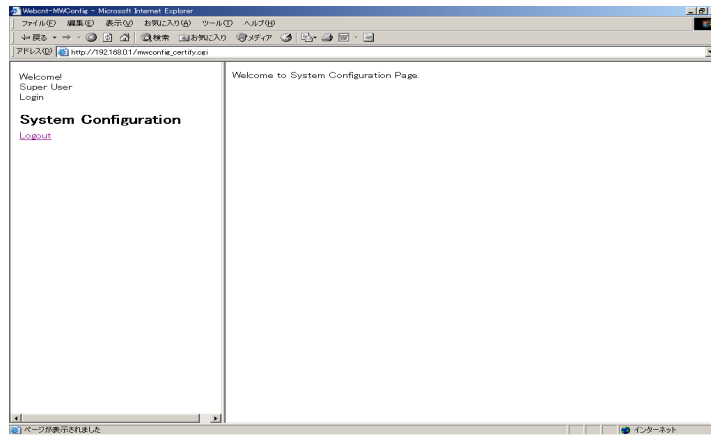

Figure 13.3 System Configuration screen with no setting authorization



### 13.1.1 Web Files Registration

This section describes how to store files in Web Controller, delete the stored files, and download the stored files from the unit.

By clicking [HTML File Registration] in the System Configuration index screen, the following screen will be displayed.

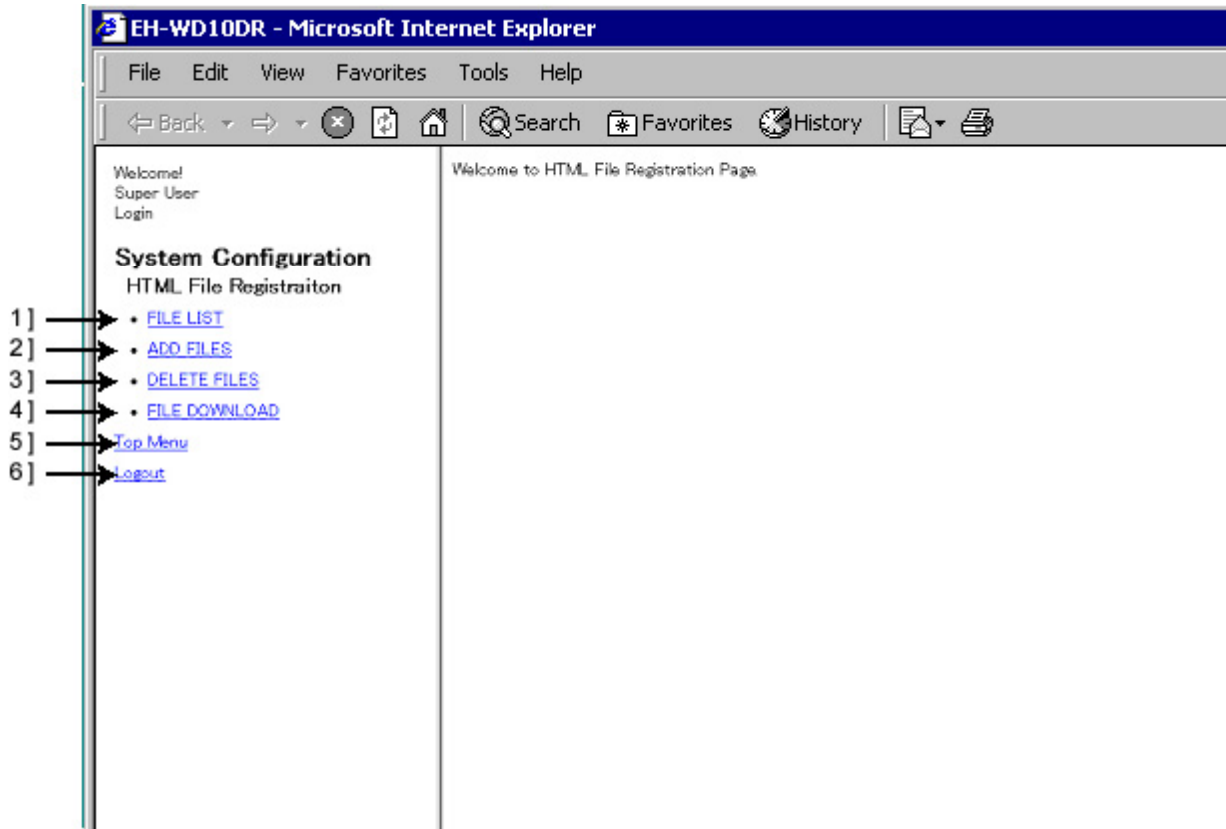

Figure 13.4 HTML File Registration Menu screen

Table 13.3 HTML File Registration Menu screen

No.	Name	Setting Options
1]	File list	Displays the list of files stored in Web Controller.
2]	Add files	Store files in Web Controller
3]	Delete files	Delete files stored in Web Controller
4]	Download files	Download files stored in Web Controller
5]	Top Menu	Return to the System Configuration index screen
6]	Logout	Logout from the System Configuration

The following files can be registered in Web Controller. Three files of “default.htm”, “comments.htm” and “d\_mobile.htm” are registered as a factory setting.

Table 13.4 File registration specifications

	Item	Description
1	Storable file types	HTML(*.htm), JPEG(*.jpg) and GIF(*.gif)
2	File names	1] number of characters 1 to 8 one byte characters + extension: 4 characters (.htm, .jpg, .gif) 2] Usable characters “A to Z,” ”a to z,” “0 to 9,” “-“ and “_” 3] Same file names can not be registered.
3	Storable file size and number of files	16,380 byte : 8 file (No.1 to 8) 8,188 byte :16 file (No.9 to 24) 4,092 byte :16 file (No.25 to 40)

HTML files to be registered in Web Controller may be freely created as Web pages with HTML tags and scripts. Web Controller supports HTML tags adopted in Microsoft Internet Explorer (“IE”) 6.0 or later versions.

(1) File list

Displays the list of files stored in Web Controller.

By clicking [File list] in the HTML File Registration menus on the left, the following screen will be displayed.

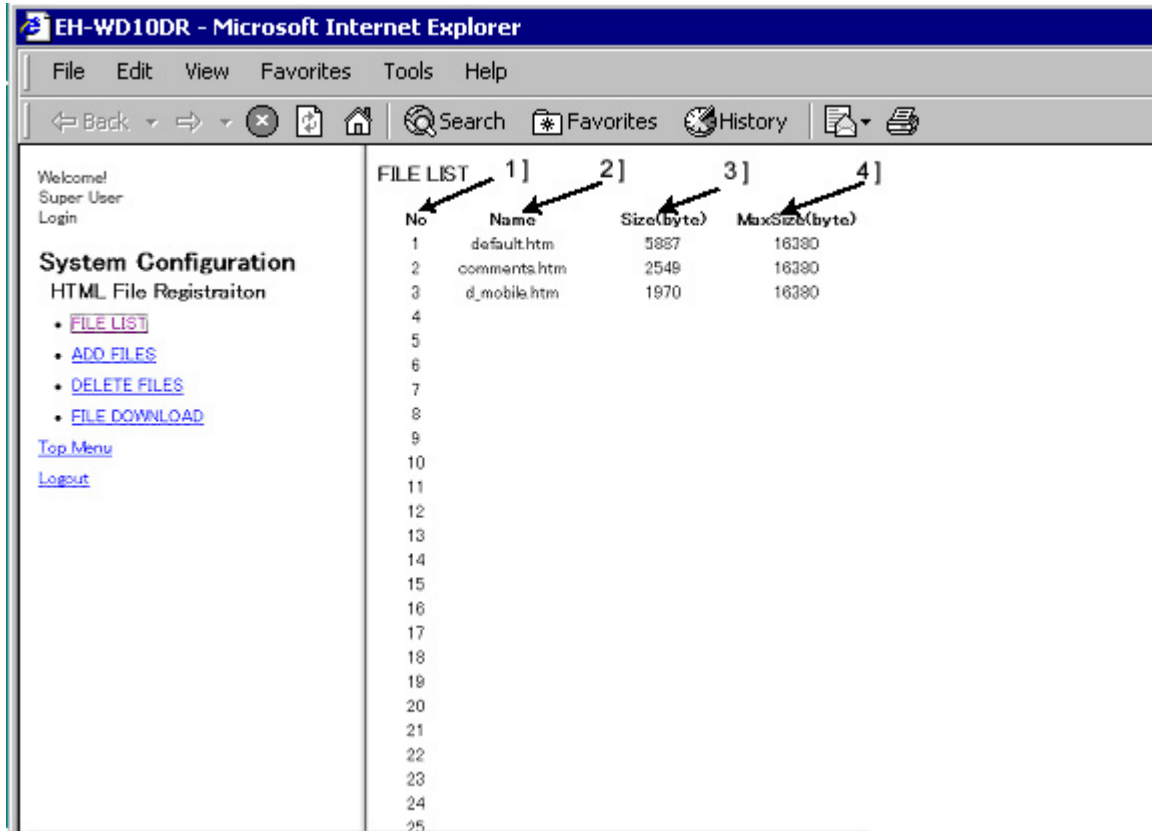

Figure 13.5 HTML File Registration – File list screen

Table 13.5 HTML File Registration – File list screen

No.	Name	Setting Options
1]	No.	File number for the stored file. Select a number when storing a file. Note that the storable file size varies depending on the file No. Refer to table 13.4 in the previous page for the storable file size.
2]	Name	Name of the stored file.
3]	Size(byte)	Size of the stored file.
4]	MaxSize(byte)	Maximum size of the file storable under the file No. Note that the file size varies depending on the file No. Refer to table 13.4 in the previous page for the storable file size.

## (2) Add files

Stores files in Web Controller.

By clicking [Add files] in the HTML File Registration menus on the left, the following screen will be displayed.

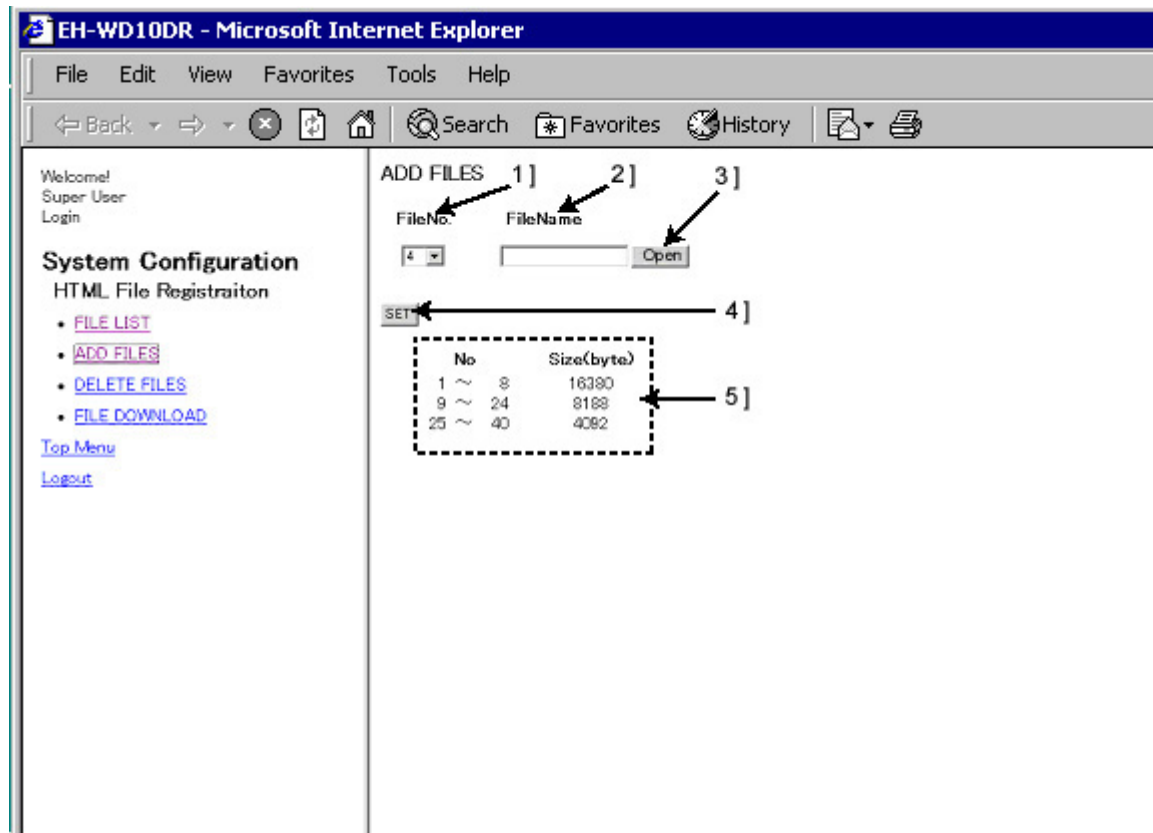

Figure 13.6 HTML File Registration – Add files screen

Table 13.6 HTML File Registration – Add files screen

No.	Name	Setting Options
1]	FileNo.	Select a file number. File number of which no file is stored can be selected.
2]	FileName	Input the path of the file name. Click the [Reference...] button (3) to display GUI for file options.
3]	[Reference...] button	Click this button to view GUI to select a file to store. Select a file, and the path of the file will appear in the FileName box (2).
4]	SET	Click this button to store the specified file.
5]	Maximum file size	File numbers and maximum file sizes storable under each file No. Check the file size when storing a file.

### ⚠ Caution!!

Setting of access authorization is not done for each file but is done for each file No. Therefore, the access authorization will be remained even if the file will be deleted. The remained access authorization information will be kept for new registered file with same file No.

(3) Delete files

Delete files stored in Web Controller.

By clicking [Delete files] in the HTML File Registration menus on the left, the following screen will be displayed.

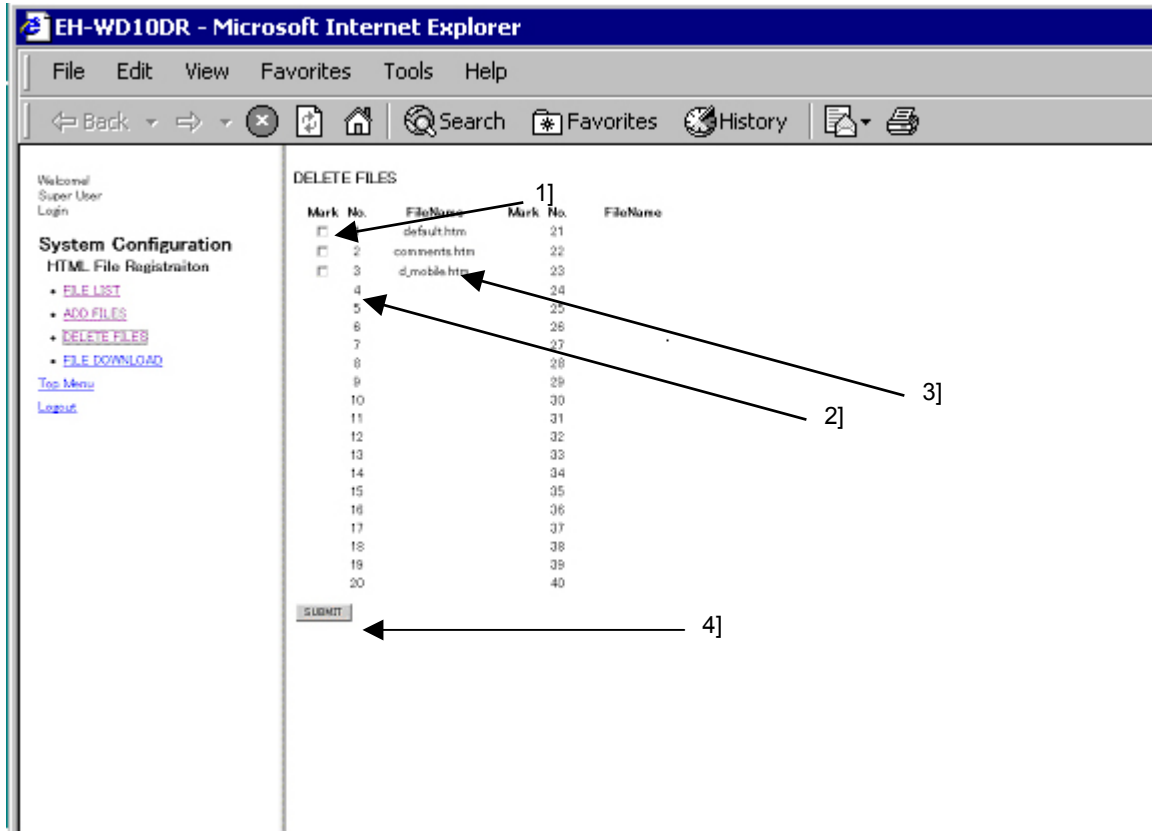

Figure 13.7 HTML File Registration – Delete files screen

Table 13.7 HTML File Registration – Delete files screen

No.	Name	Setting Options
1]	Check box	Check the checkbox of the file to delete.
2]	No.	File number for the stored file
3]	FileName	Name of the stored file.
4]	SUBMIT	Click this button to delete the files whose checkboxes are checked.

**⚠ Caution!!**

Setting of access authorization is not done for each file but is done for each file No. Therefore, the access authorization will be remained even if the file will be deleted. The remained access authorization information will be kept for new registered file with same file No.

## (4) Download files

Download files stored in Web Controller

By clicking [Download files] in the HTML File Registration menus on the left, the following screen will be displayed.

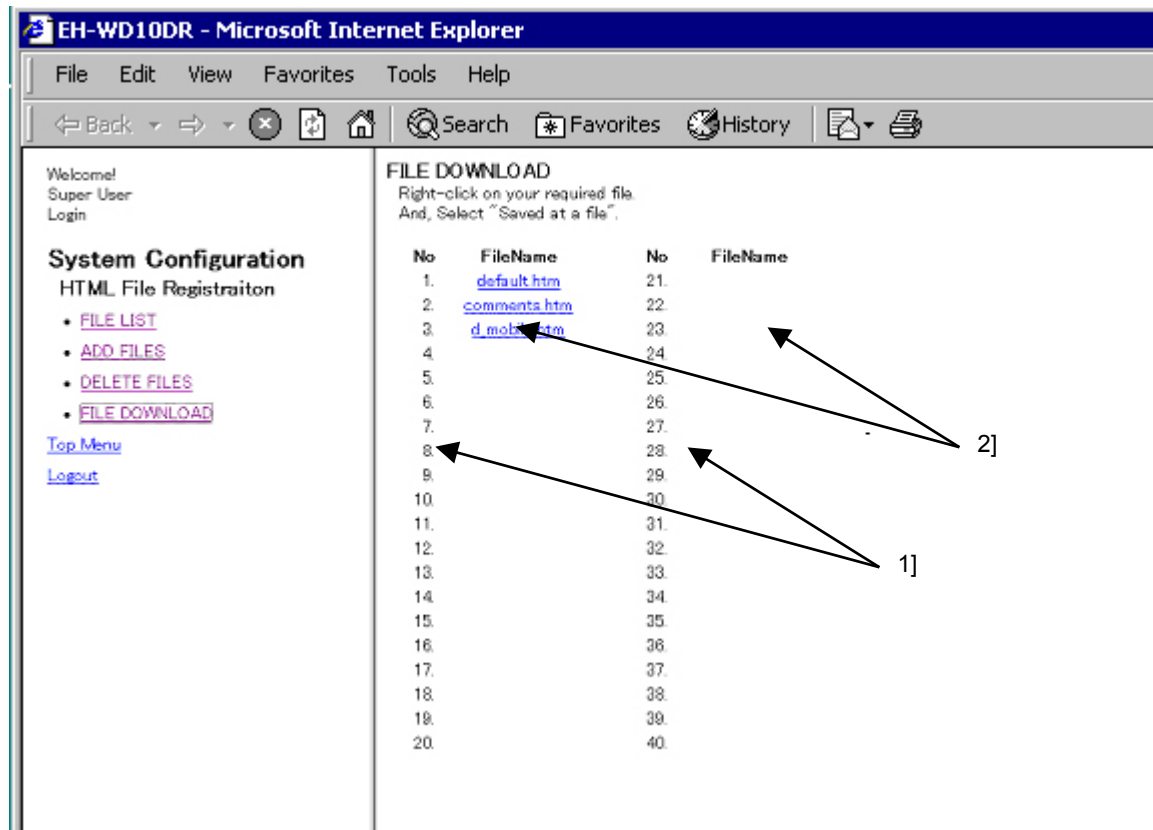

Figure 13.8 HTML File Registration – Download files screen

Table 13.8 HTML File Registration – Download files screen

No.	Name	Setting Options
1]	No.	File number for the stored file.
2]	FileName	<p>Name of the stored file.</p> <p>Each FileName is a link to the file stored with the name. <b>To download a file, place the cursor over the link, select [Save Target in] from the right-click menu, and specify a folder to store the file and the file name.</b></p> <p>By clicking this link, descriptions of the file are displayed in the Download files main screen on the right. Note that this operation will not convert the extension tag to the data on data memory.</p>

### 13.1.2 IP Address Registration

This section describes how to perform settings of the IP address, DNS and NTP for Web Controller. By clicking [IP Address] in the System Configuration index screen, the following screen will be displayed.

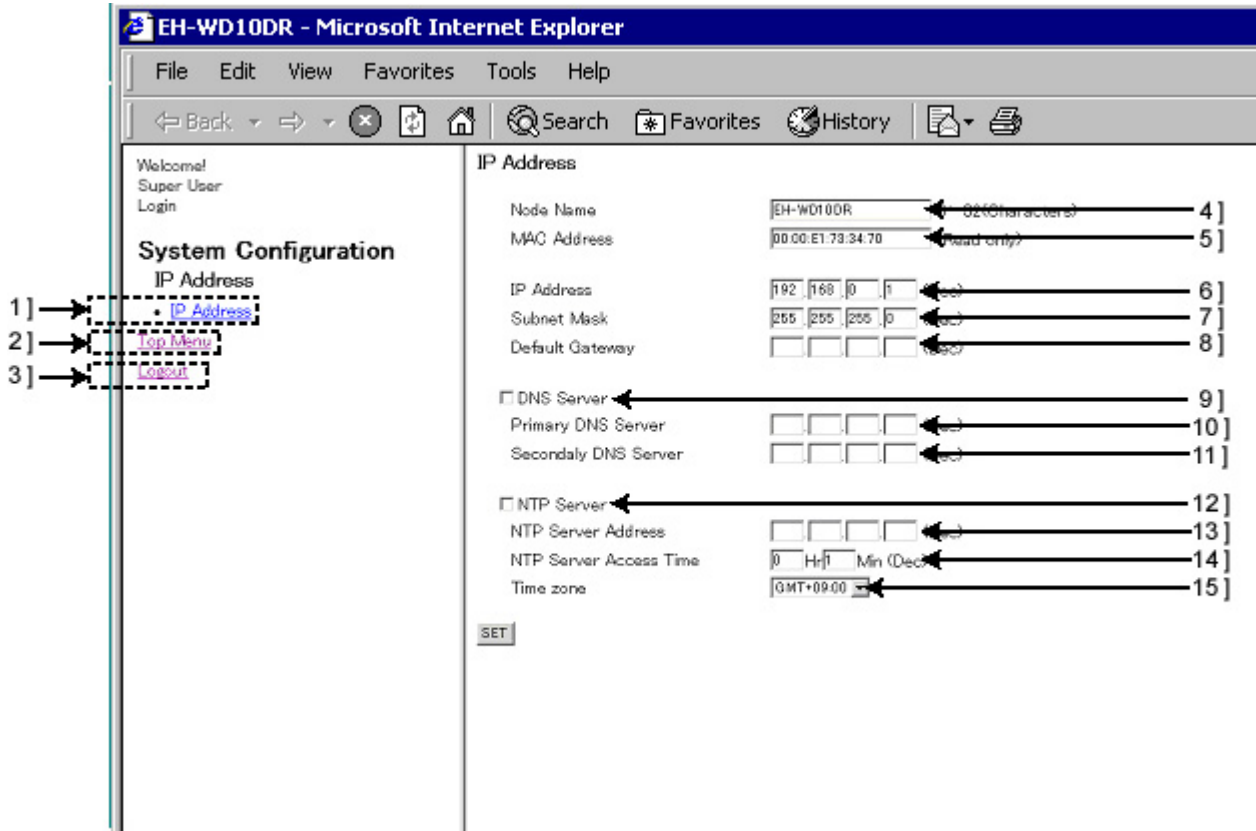

Figure 13.9 IP Address setting screen

Table 13.9 IP Address setting screen

No.	Name	Setting Options
1]	IP Address	Displays the IP Address setting screen again in the Main screen on the right. Use this menu to read out the current status while processing the setting.
2]	Top Menu	Return to the System Configuration index screen
3]	Logout	Logout from the System Configuration
4]	Node Name	Input the node name. Specify using 0 - 32 one byte characters.
5]	MAC Address	MAC address set to Web Controller is displayed. (Read only)
6]	IP Address	Input the IP address of Web Controller.
7]	Subnet Mask	Input the subnet mask of a network group in which Web Controller resides.
8]	Default Gateway	Input the default gateway of a network group in which Web Controller resides.
9]	DNS Server	Specify if DNS server is used or not. Check the checkbox to use the server. <b>Be sure to set the DNS server if POP and SMTP servers are specified by domain names for sending e-mails.</b>
10]	Primary DNS Server	Input the IP address of Primary DNS server.
11]	Secondary DNS Server	Input the IP address of Secondary DNS server.
12]	NTP Server	Set whether or not to access NTP server to update the current time. Check the checkbox to update the current time.
13]	NTP Server Address	Input the IP address of NTP server to be accessed from Web Controller
14]	NTP Server Access Time	Set the interval of the access to NTP server from Web Controller. Set it to 0 to 99 [Hr], 0 to 59 [Min].
15]	NTP Server Time Zone	Select a time zone. Default is the Japan Standard Time (GMT + 09:00). Note that this function does not support Daylight Saving Time.

Complete the IP address and other settings, and click the [SET] button. By clicking the button, the following screen is displayed if all the data is properly set. Click the [OK] button on this screen, and Web Controller reboots. Then, the OK LED on Web Controller will blink for several seconds. When the blinking stops and the OK LED lights up again, reboot process is complete, and settings including the IP address is reflected in Web Controller.

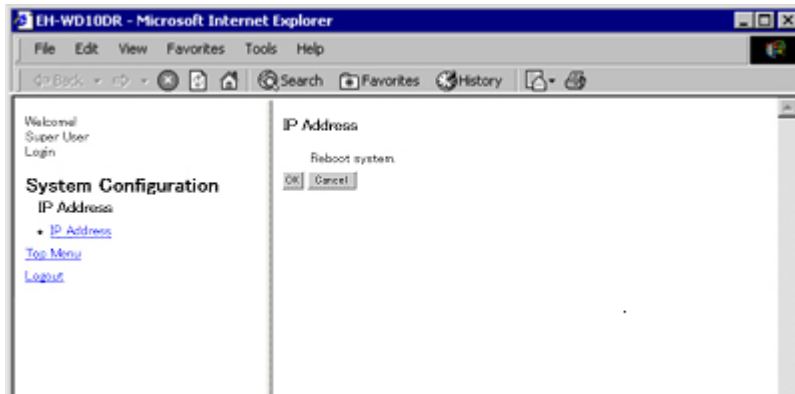

Figure 13.10 Reboot confirmation screen

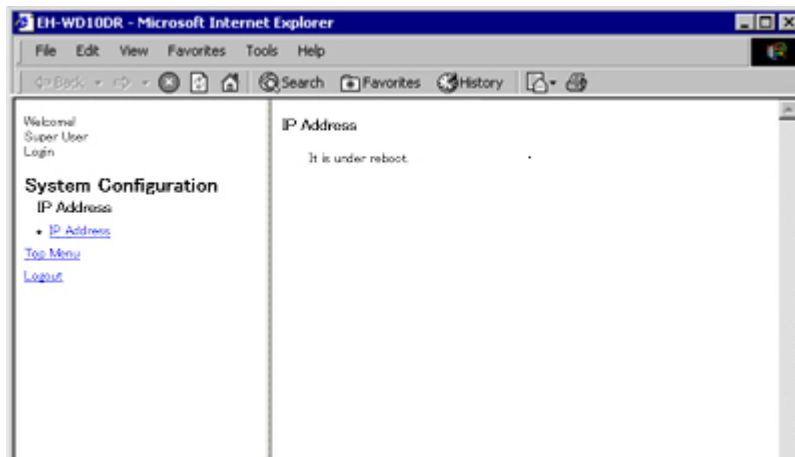

Figure 13.11 Reboot screen

### ⚠ Caution!!

Note that Web Controller must be restarted to reflect changes to IP address. Make sure to go through the restarting process using this function to restart, but never shut off and re-supply the power for the purpose.



### 13.1.3 Mail Settings

This section describes how to perform e-mail settings on Web Controller. By clicking [Mail Settings] in the System Configuration index screen, the following screen will be displayed.

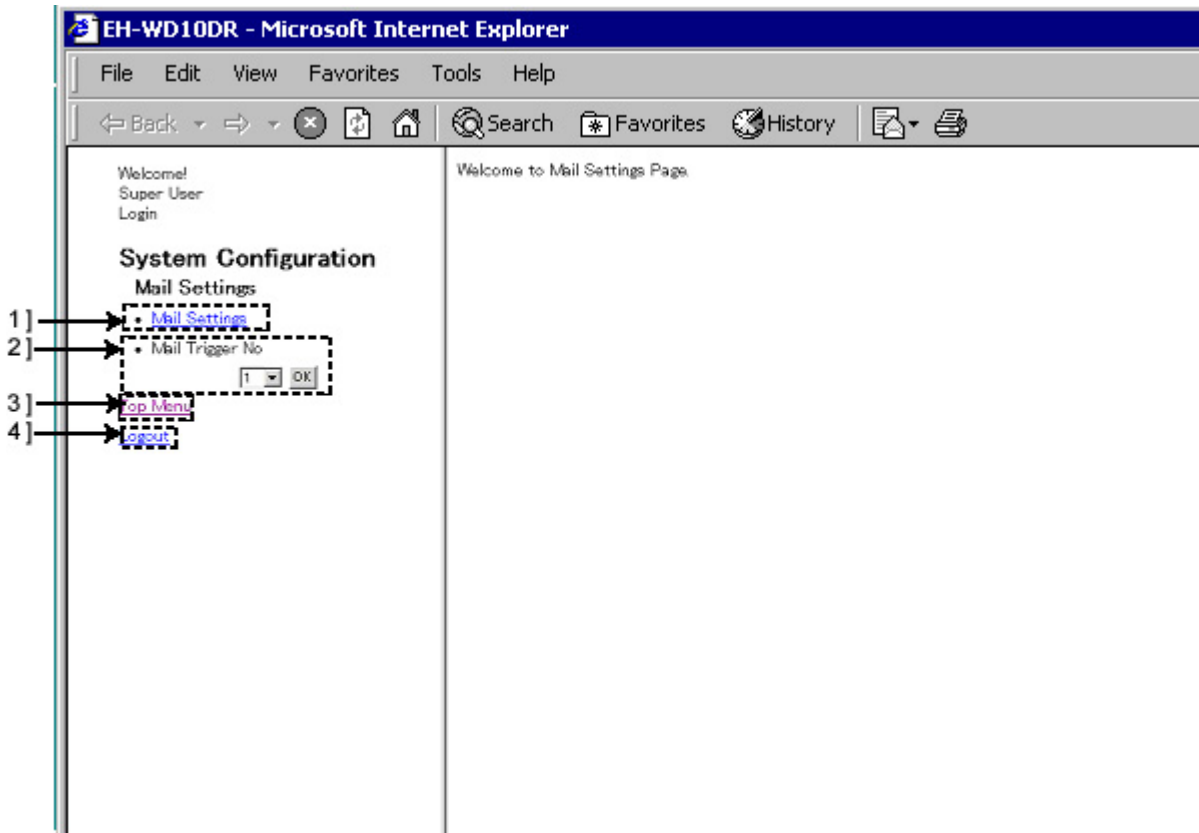

Figure 13.12 Mail Settings menu screen

Table 13.10 Mail Settings menu screen

No.	Name	Setting Options
1]	Mail Settings	Displays the e-mail basic setting screen.
2]	Mail Trigger No.	Select a trigger number from No.1 to 16 from the pull-down menu, and click the [OK] button to view the e-mail trigger setting screen for each trigger No.
3]	Top Menu	Return to the System Configuration index screen
4]	Logout	Logout from the System Configuration

## (1) E-mail basic settings

Under the Mail Settings menu, basic settings for sending e-mails can be performed.

By clicking [Mail Settings] in the Mail Settings menu on the left, the following screen will be displayed.

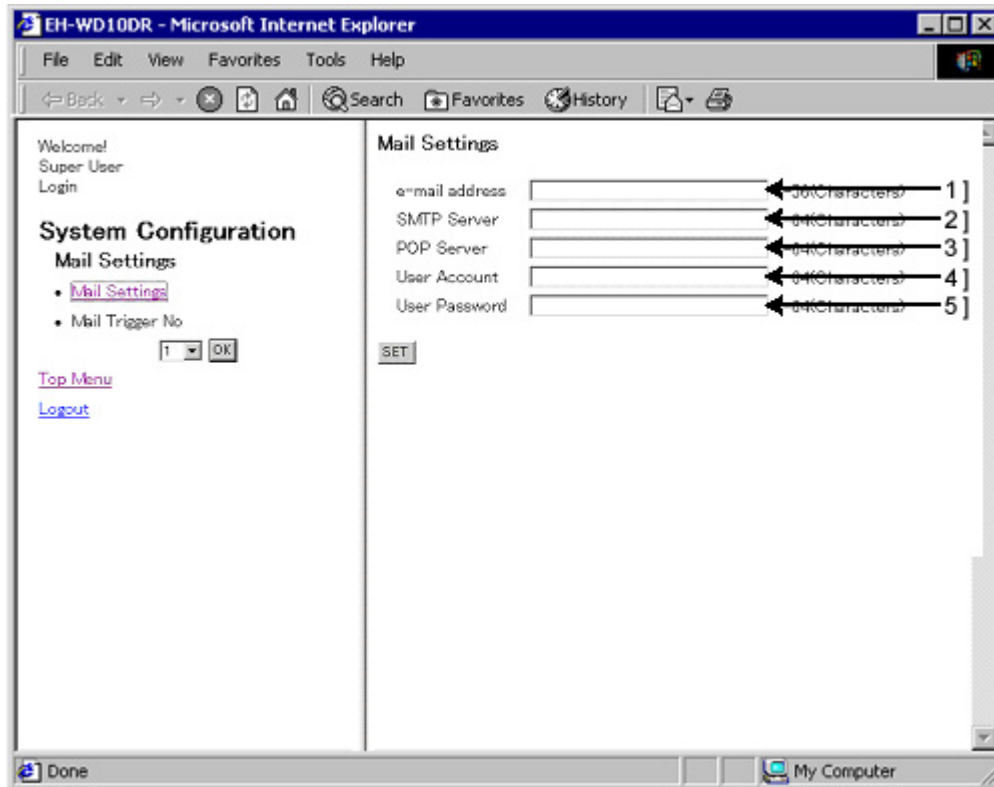

Figure 13.13 Mail Settings - basic setting menu

Table 13.11 Mail Settings - basic setting menu

No.	Name	Setting Options
1]	e-mail address	Input an e-mail address to be used as a sender of e-mails.
2]	SMTP Server	Input the address of SMTP server. <b><u>Be sure to set the DNS server in the IP Address Configuration screen when specifying the SMTP server using domain names.</u></b>
3]	POP Server	Input the address of POP server. <b><u>Be sure to set the DNS server in the IP Address Configuration screen when specifying the POP server using domain names.</u></b>
4]	User Account	Input the user account for POP authentication.
5]	User Password	Input a password for the user account for POP authentication.

(2) E-mail trigger settings

This section describes how to set triggers for sending e-mails and e-mail contents on Web Controller.

By selecting a trigger number to set from the pull-down menu in the Mail Settings menu on the left, and clicking the [OK] button, the following screen will be displayed (this is an example screen for Trigger No. 1). Trigger No. 1 to 16 can be used.

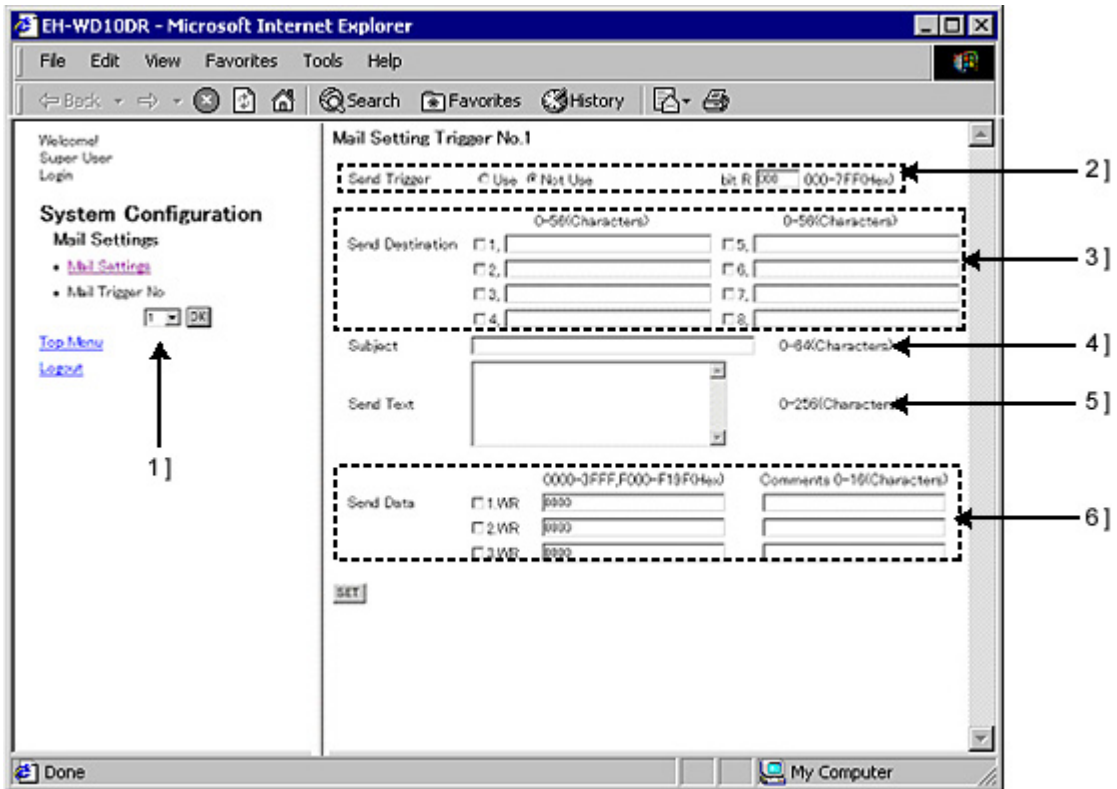

Figure 13.14 Mail Settings - Trigger setting screen

Table 13.12 Mail Settings - Trigger setting screen

No.	Name	Setting Options
1]	Mail Trigger No.	Select a trigger number to be used for sending e-mails. (Description of the selected trigger is indicated in 4].) Up to 16 triggers can be set.
2]	Trigger	Settings of the e-mail send trigger. Select “Use” or “Not Use” for each trigger. If you select “Use,” select a bit internal output “R” to be used as the trigger and input it.
3]	E-mail address	Input destinations of outgoing e-mails. Up to 8 destinations can be set for each trigger.
4]	Subject	Input the subject of the outgoing e-mail. Up to 64 one-byte characters or 32 double-byte characters can be used. *
5]	Text	Input the text of the outgoing e-mail. Up to 256 one-byte characters or 128 double-byte characters can be used. *
6]	Sent Data	Internal output data can be added to the e-mail text to the maximum of 3 words. A comment can also be added for each word. Up to 16 one-byte characters or 8 double-byte characters can be used to add a comment. *

\* Make sure of not exceeding the maximum byte when both one-byte character and double-byte characters are specified.

### 13.1.4. Ethernet Protocol Settings

This section describes how to perform settings of network connection information for programming Web Controller with the programming software (LADDER EDITOR for Windows). This information is also required for application of HMI software including display devices supported by Ethernet connection for HITACHI H/EH series PLC and SCADA.

By clicking [Ethernet Protocol] in the System Configuration index screen, the following screen will be displayed.

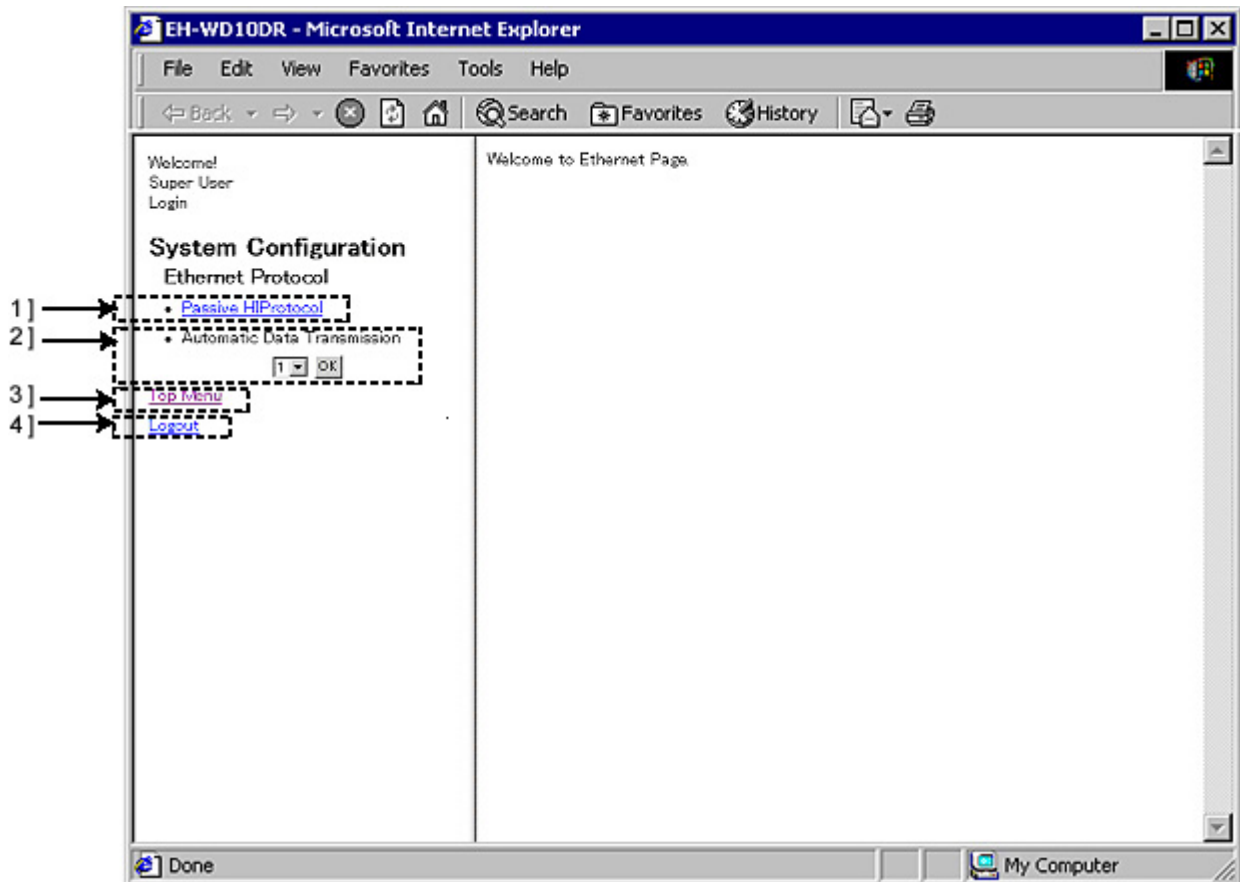

Figure 13.15 Ethernet Protocol menu screen

Table 13.13 Ethernet Protocol menu screen

No.	Name	Setting Options
1]	Passive HIProtocol	Settings of task code communication
2]	Automatic Data Transmission	Settings of message communication
3]	Top Menu	Return to the System Configuration index screen
4]	Logout	Logout from the System Configuration

(1) Task code communication

Settings of task code communication.

By clicking [Passive HIProtocol] in the Ethernet Protocol menu on the left, the following screen will be displayed.

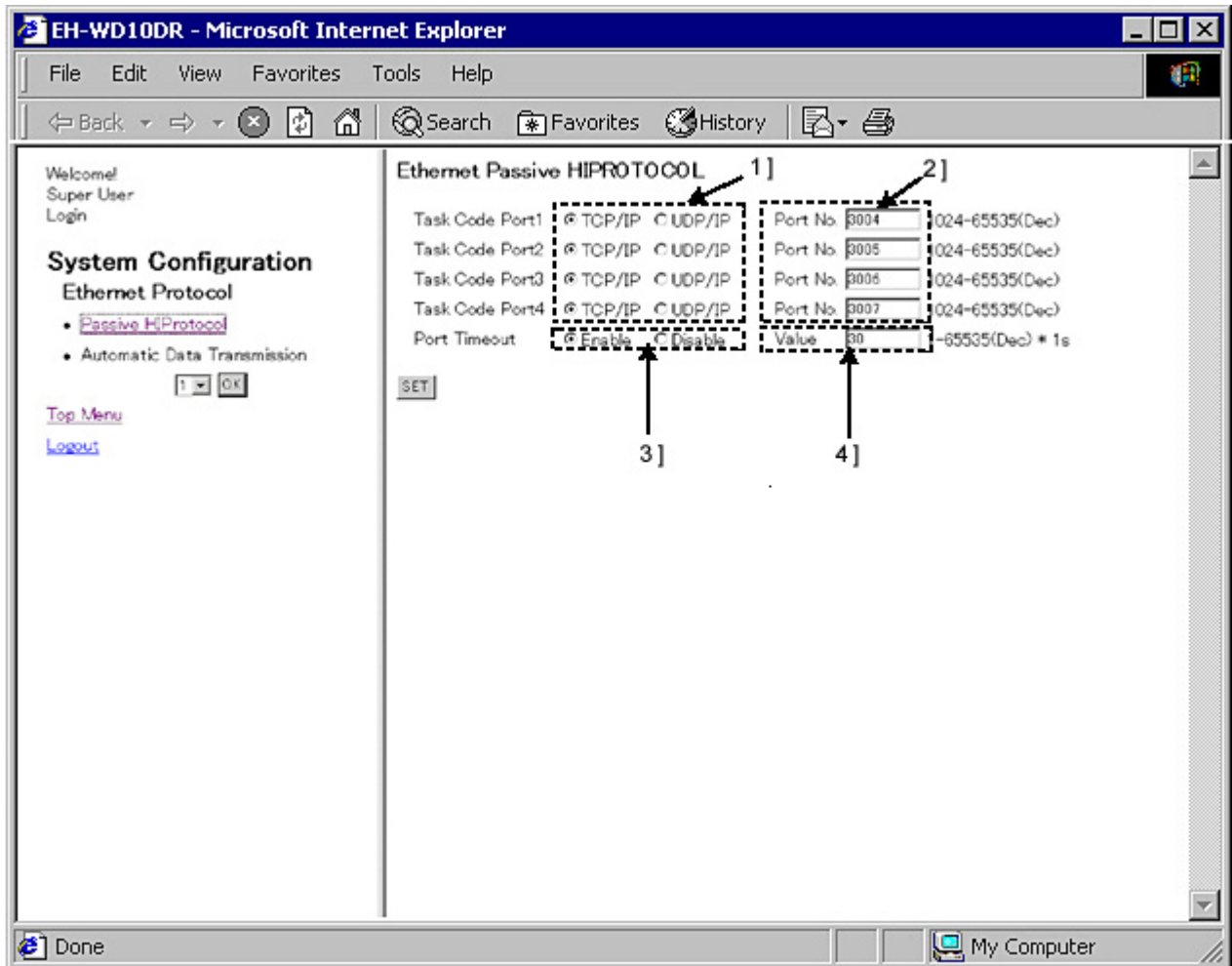

Figure 13.16 Ethernet Protocol - Passive HIProtocol setting screen

Table 13.14 Ethernet Protocol - Passive HIProtocol setting screen

No.	Name	Setting Options
1]	Task Code Port	Select a connection protocol for task code. Mark either TCP/IP or UDP/IP.
2]	Port No.	Set the logical port number of the connection for task code. Input a number in the range of 1024 to 65535.
3]	Port Timeout	Set whether or not to enable timeout for the connection for task code. This value affects to all connections for task code. Setting it to “Disable” will disable 4] as well. This timeout function monitors the duration of time when no TCP packet is received at the task cord port. When a timeout is detected, the task cord port sends out a packet including a connection cut-off request flag (FIN ACK).
4]	Value	Input the timeout duration for the connection for task code (in seconds). This value affects to all connections for task code. Input a number in the range of 1 to 65535.

## (2) Message communication

This section describes how to perform message communication settings.

To set the message communication, select a connection number to set from the pull-down menu in the Ethernet Protocol menu on the left, and click the [Go] button to display the following screen.

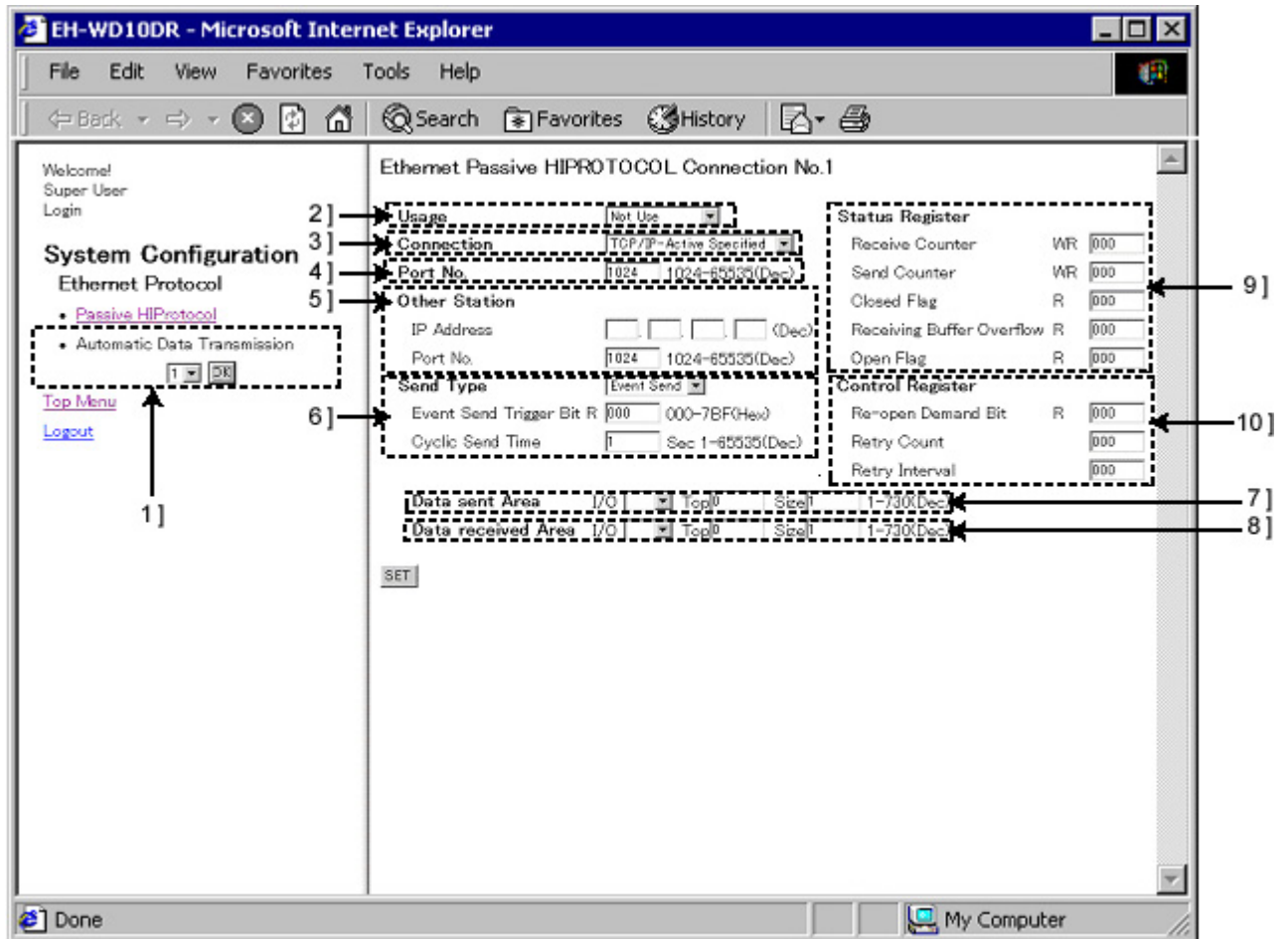

Figure 13.17 Ethernet Protocol – message communication setting screen

Table 13.15 Ethernet Protocol – message communication setting screen

No.	Name	Setting Options
1]	Automatic Data Transmission	Select a connection number.
2]	Usage	Select a communication usage. Not Use Send/Receive Send Receive
3]	Connection	Select a connection type. TCP/IP-Active Specified TCP/IP-Passive Specified TCP/IP-Passive Optional UDP/IP Specified UDP/IP Optional
4]	Port No.	Input the port number of Web Controller.
5]	Other Station	Set the other station. IP Address Port No.
6]	Send Type	Select a sending type. Send Type Event Send Cyclic Send Event Send Trigger Bit R Cyclic Send Time
7]	Data sent Area	Select an area to send data from. I/O: WR/WM/WX/WY Top Size: 1-730 (Dec)
8]	Data received Area	Select an area to receive data. I/O: WR/WM/WY Top Size: 1-730(Dec)
9]	Status Register	Set the status register. Receiving Counter Transmitting Counter Closed Flag Receiving Buffer Overflow Open Flag
10]	Control Register	Set the control register. a) Re-open Demand Bit b) Retry Count c) Retry Interval

### 13.1.5 Serial Port Settings

This section describes how to perform settings of communication using the serial port of Web Controller. By clicking [RS-232C Protocol] in the System Configuration index screen, the following screen will be displayed.

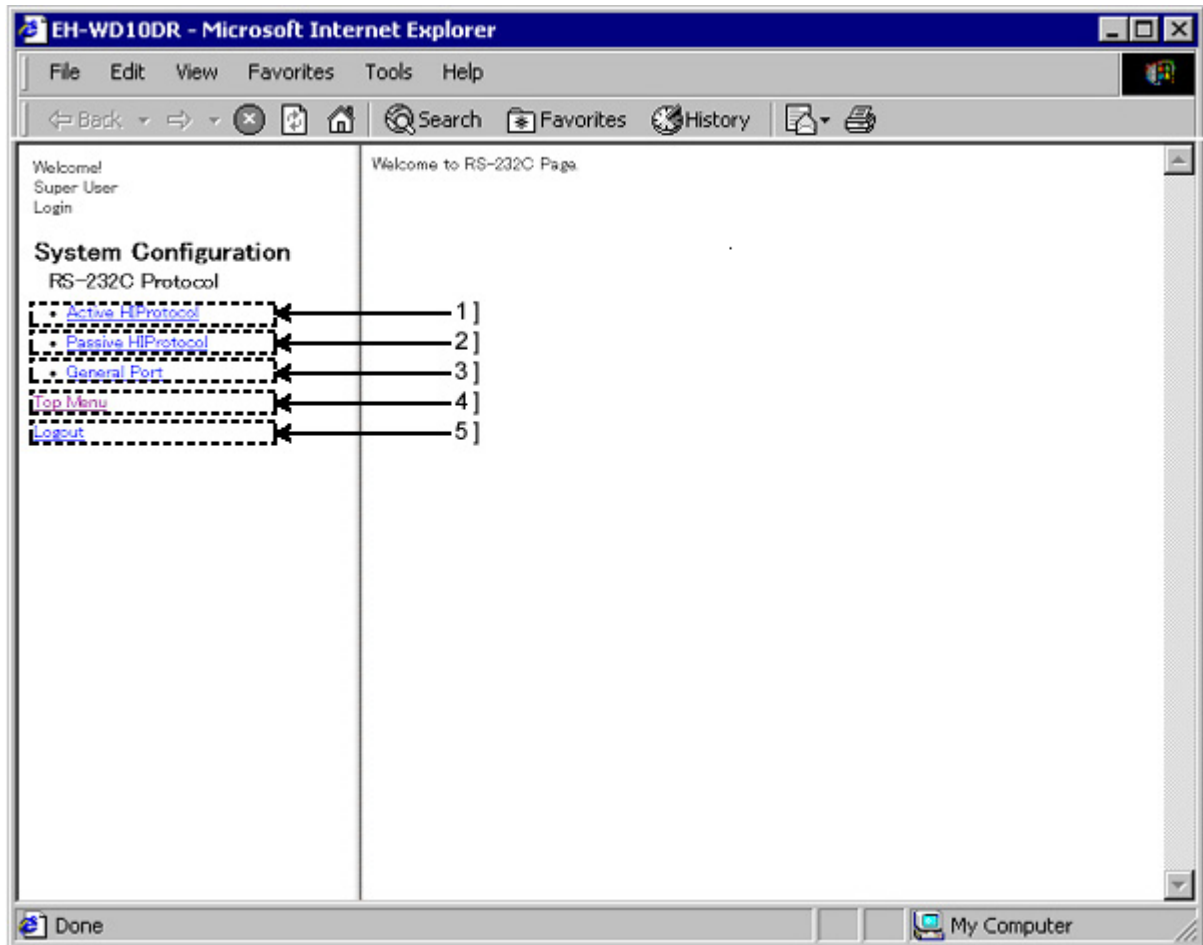

Figure 13.18 RS-232C Protocol menu screen

Table 13.16 RS-232C Protocol menu screen

No.	Name	Setting Options
1]	Active HIProtocol	Perform settings of RS-232C Active-HIProtocol.
2]	Passive HIProtocol	Perform settings of RS-232C Passive-HIProtocol.
3]	General Port	Perform settings of RS-232C general purpose communication port.
4]	Top Menu	Return to the System Configuration index screen
5]	Logout	Logout from the System Configuration

#### ⚠ Caution!!

Using serial port Active HIProtocol, Passive HIProtocol and General Port is not allowed at once in Web Controller. If one of these settings is “Use”, the other settings will be “Not Use” automatically.



(1) Active-HIProtocol

This section describes how to perform RS-232C Active HIProtocol settings on Web Controller.

By clicking [Active HIProtocol] in the RS-232C Protocol menu on the left, the following screen will be displayed.

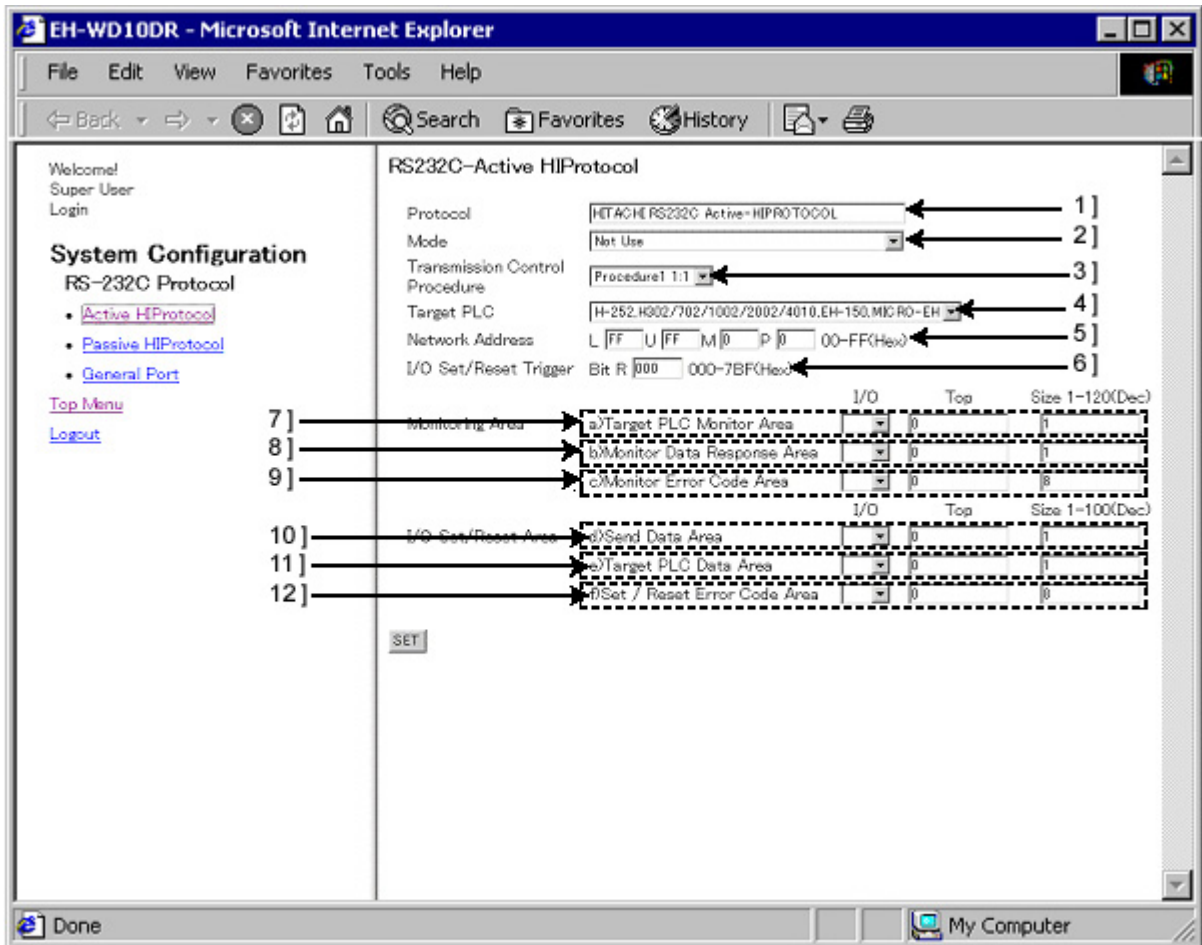
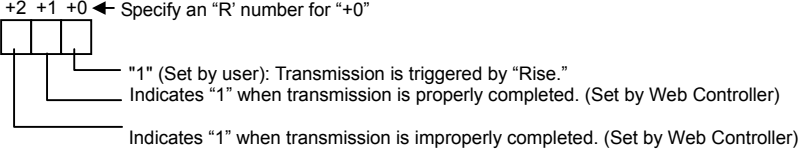

Figure 13.19 RS-232C Protocol - Active HIProtocol menu screen

Table 13.17 RS-232C Protocol - Active HIProtocol menu screen

No.	Name	Setting Options
1]	Protocol	Displays the protocol name (Active HIProtocol). This textbox is unchangeable.
2]	Mode	Select a communication mode. Not Use Monitor only Monitor & I/O Set/Reset Trigger Datalink (Monitor & I/O Set/Reset alternately)
3]	Transmission Control Procedure	Select a transmission procedure. a) Procedure1 1:1 b) Procedure2 1:1
4]	Target PLC	Select the type of connected PLC. a) H-20/40/64, H-200/250, H-300/700/2000 b) H-252, H302/702/1002/2002/4010, EH-150, MICRO-EH
5]	Network Address	Input the network address defined by the task code which is the protocol of HITACHI H/EH-series PLC. Refer to Appendix 2 in Controller Manual for details.
6]	Writing trigger bit	If the communication mode is set to "Monitor & I/O Set/Reset Trigger," select a bit internal output "R" to be used as the trigger. 
7]	Target PLC address	Specify a monitoring data area on the connected PLC to read out data from. a) I/O type: Select from WR/WM/WL/WX/WY b) Top I/O number: c) Size: Max. 120 words (hexadecimal)
8]	Stored address	Specify an area on Web Controller to store data received from the connected PLC. a) I/O type: Select from WR/WM/WY. b) Top I/O number: c) Size: (The number of areas specified in 7] is ensured.)
9]	Error code address	Specify an area to store error codes when data from the connected PLC fails to be received. a) I/O type: Select from WR/WM. b) Top I/O number: c) Size: (Fixed to 8 words)
10]	Source address	Specify a sending area on the Web Controller. a) I/O type: Select from WR/WM/WX/WY. b) Top I/O number: c) Size: Max. 100 words (hexadecimal)
11]	Target PLC address	Specify a forced set area on the connected PLC. a) I/O type: Select from WR/WM/WL/WY. b) Top I/O number: c) Size: (The number of areas specified in 10] is ensured.)
12]	Error code address	a) I/O type: Select from WR/WM. b) Top I/O number: c) Size: (Fixed to 8 words)

(2) Passive-HIProtocol

This section describes how to perform settings of RS-232C Passive HIProtocol on Web Controller.

By clicking [Passive HIProtocol] in the RS-232C Protocol menu on the left, the following screen will be displayed.

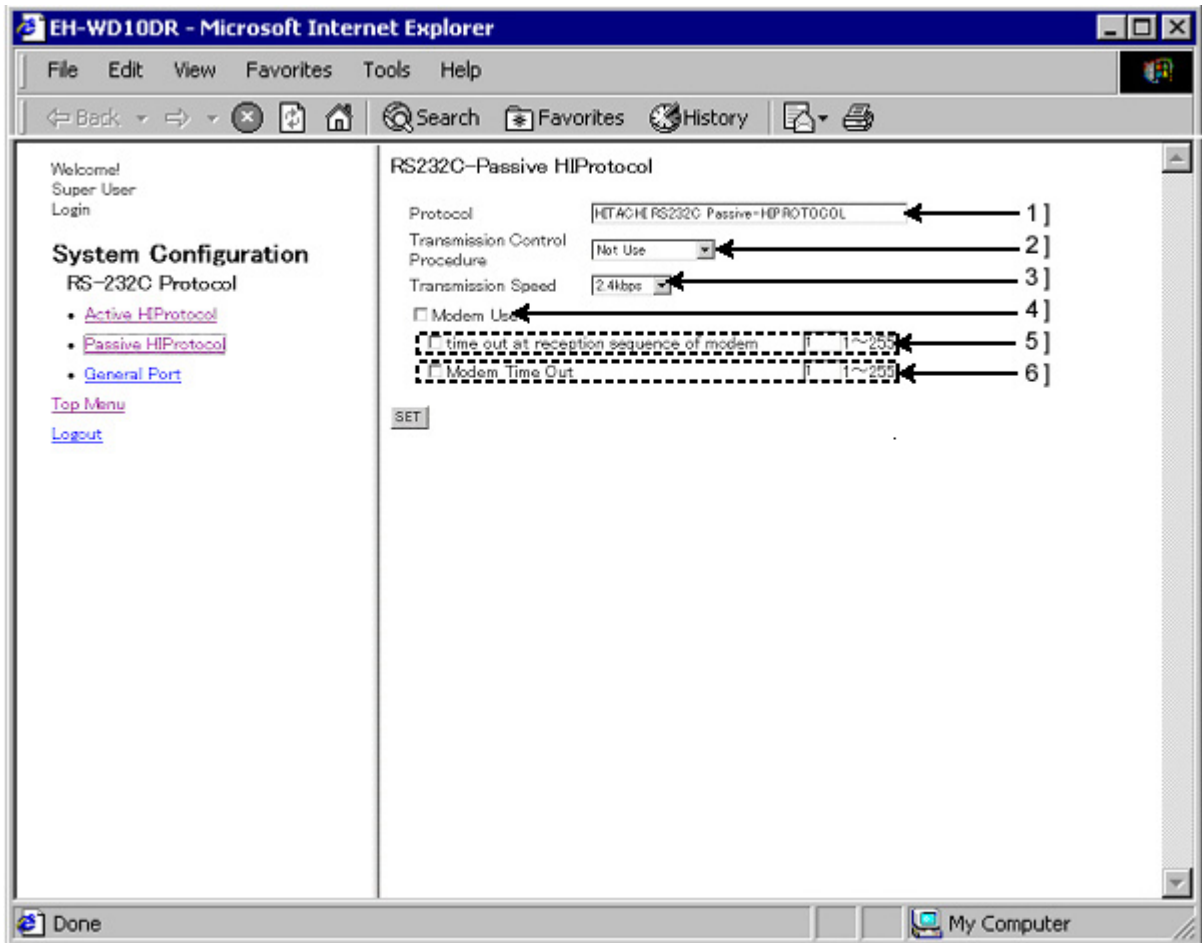

Figure 13.20 RS-232C HIProtocol - Passive HIProtocol menu screen

Table 13.18 RS-232C HIProtocol - Passive HIProtocol menu screen

No.	Name	Setting Options
1]	Protocol	Displays the protocol name (Passive HIProtocol). This textbox is unchangeable.
2]	Transmission Control Procedure	Select a transmission procedure. a) Not Use b) Procedure1 1:1 c) Procedure2 1:1
3]	Transmission Speed	Select a transmission speed. a) 2.4kbps b) 4.8kbps c) 9.6kbps d) 19.2kbps e) 38.4kbps f) 57.6kbps
4]	Modem Use	Set whether or not to use a modem. Check the checkbox to use.
5]	Time out at reception sequence of modem	Set the timeout at reception sequence of modem. To use the timeout reception sequence of modem, check the checkbox and input the duration of time in the range of 1 to 255.
6]	Modem Time Out	Set the modem timeout. To use the modem timeout, check the checkbox and input the duration of time in the range of 1 to 255.

## (3) General Port

This section describes how to perform settings of RS-232C General purpose communication on Web Controller.

By clicking [General Port] in the RS-232C Protocol menu on the left, the following screen will be displayed.

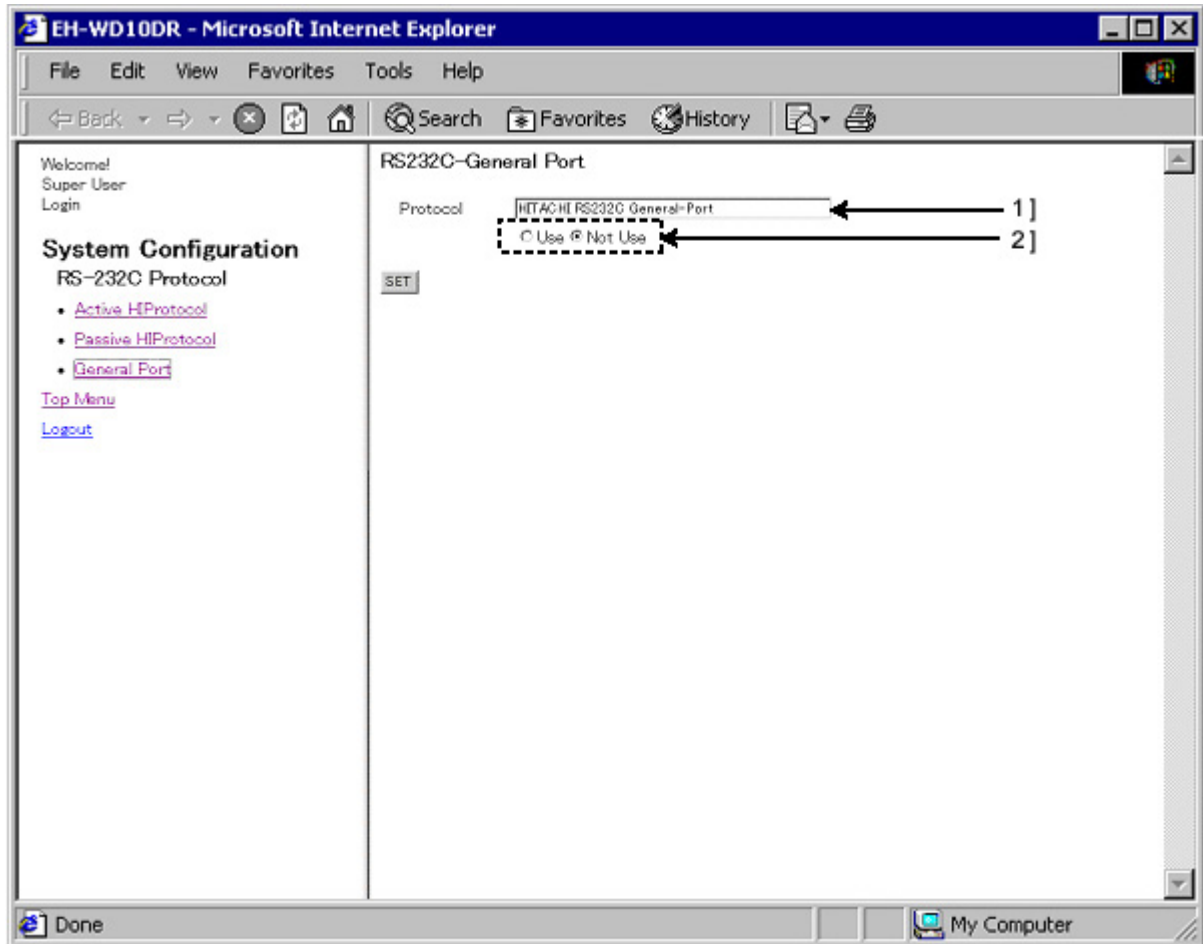

Figure 13.21 RS-232C HIProtocol - General Port menu screen

Table 13.19 RS-232C HIProtocol - General Port menu screen

No.	Name	Setting Options
1]	Protocol	Displays the protocol name (General Port). This textbox is unchangeable.
2]	General Purpose Communication Setting	Select whether or not to use the general purpose communication. a) Use b) Not Use

### 13.1.6 ID/Password Settings

This section describes how to perform ID/Password settings on Web Controller. By clicking [ID/Password] in the System Configuration index screen, the following screen will be displayed.

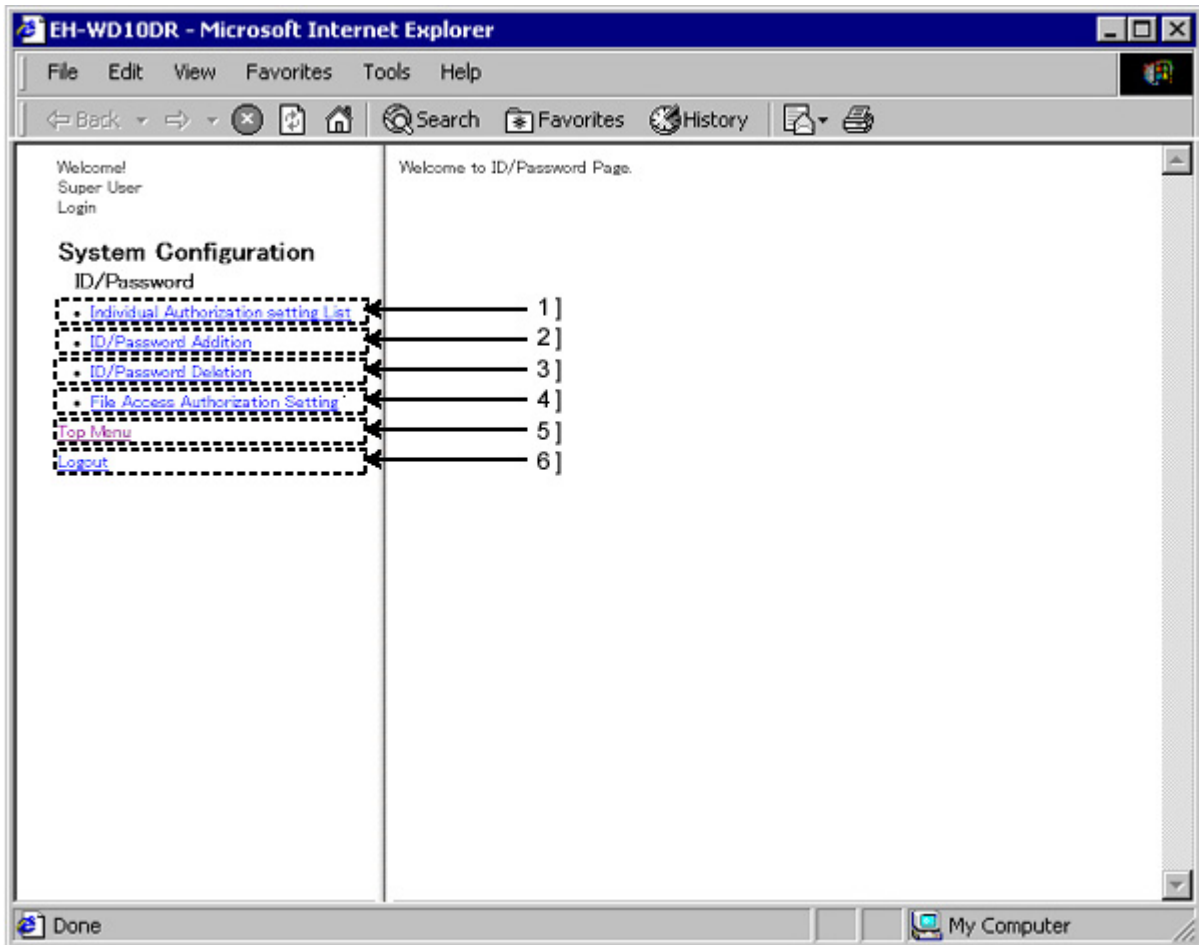

Figure 13.22 ID/Password menu screen

Table 13.20 ID/Password menu screen

No.	Name	Setting Options
1]	Individual Authorization setting List	Displays file access authorization for each user ID.
2]	Add ID/Password	Register User IDs/Passwords.
3]	Delete ID/Password	Delete User IDs/Passwords.
4]	Set file access authorization setting	Set the file access authorization.
5]	Top Menu	Return to the System Configuration index screen
6]	Logout	Logout from the System Configuration

## (1) Individual Authorization setting List

Displays a list of file access authorization for each registered user ID.

By clicking [Individual Authorization setting List] in the ID/Password menu on the left, the following screen will be displayed.

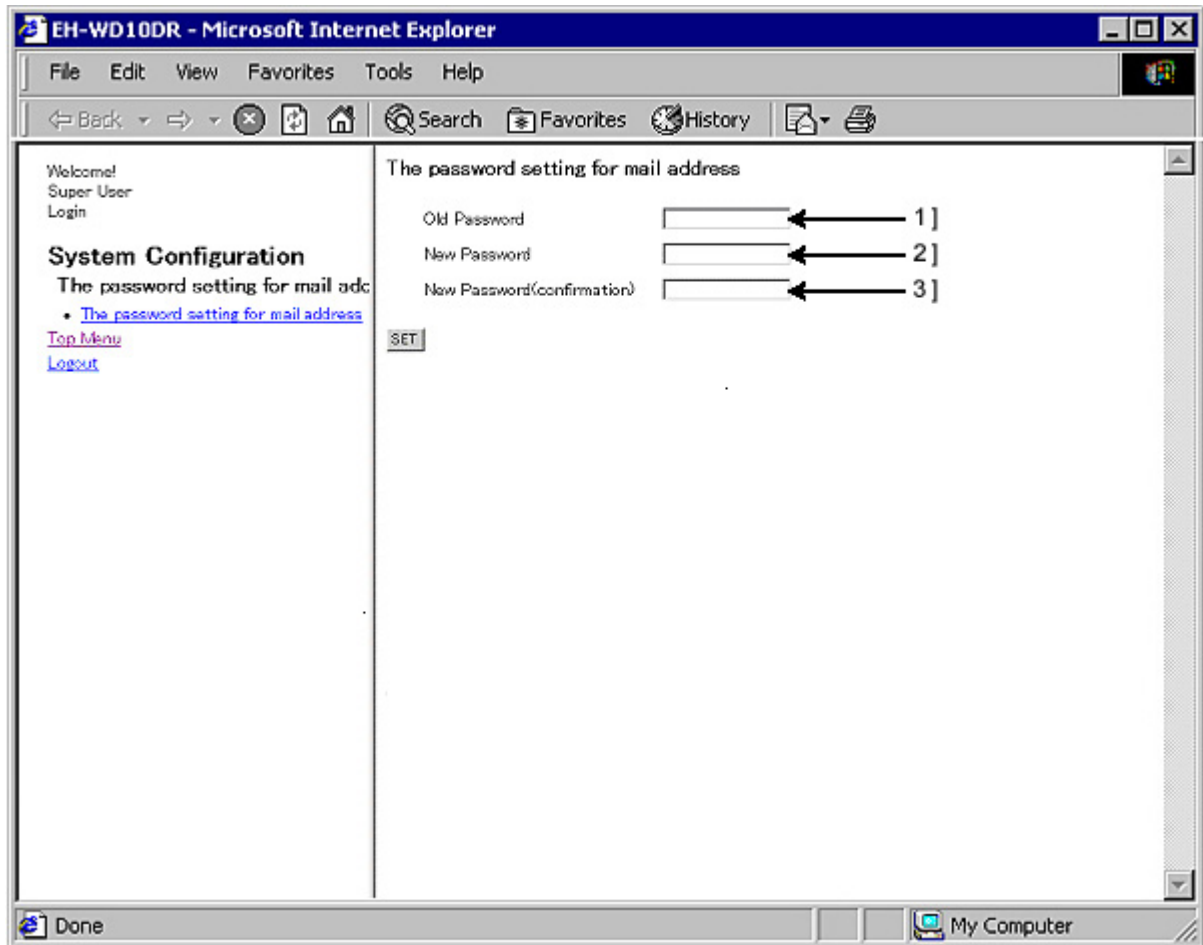

Figure 13.23 ID/Password - Individual Authorization setting List screen

Table 13.21 ID/Password - Individual Authorization setting List screen

No.	Name	Setting Options
1]	No.	Displays User ID No.
2]	User ID	Displays User ID. Click this link to view a list of access authorization for each User ID.

Click the user name on this screen to display the file access authorization of the user.

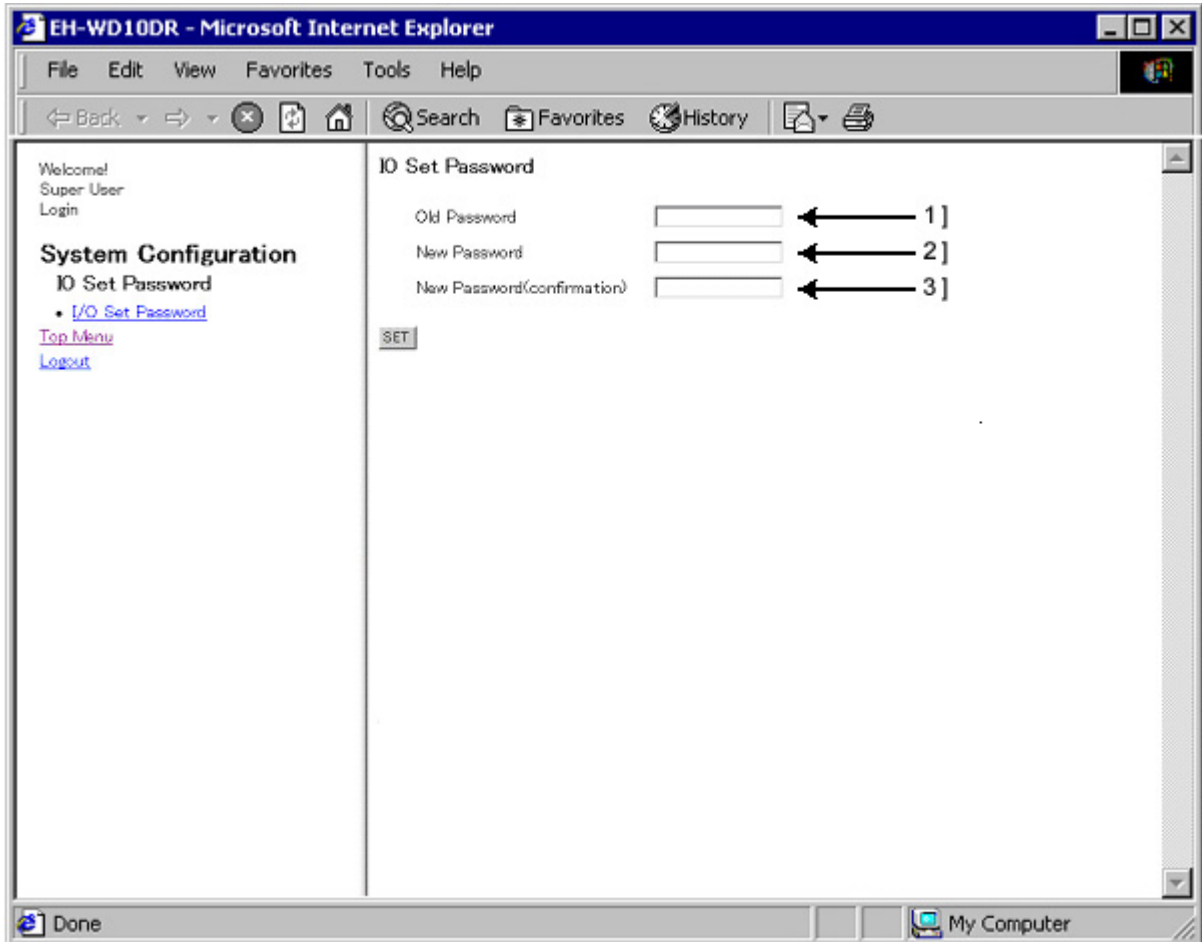

Figure 13.24 ID/Password - Individual Authorization setting List display screen

Table 13.22 ID/Password - Individual Authorization setting List display screen

No.	Name	Setting Options
1]	User ID	Displays the User ID whose list of access authorization is being displayed.
2]	No.	Displays File No.
3]	File Name	Displays File Name. No file name is displayed when Web Controller stores no file under the File No.
4]	Disable ID/Password	Indicates the ID/Password authentication is required or not when accessing the file. Check the checkbox to disable the ID/Password authentication.
5]	Status	Indicates whether or not the user is authorized to access the file. Without the access authorization, the user cannot access the file even if his/her ID/Password is authenticated. Authorized : Access to the file is permitted. Not Authorized : Access to the file is not permitted.

**⚠ Caution!!**

Note that if the “Disable ID/Password” checkbox is checked, the file can be accessed without ID/Password even if the Status is set to “Not authorized.” This happens because Web Controller performs processing based on the Disable ID/Password status first. Only when the checkbox is not marked, the setting of the Status is effective on the processing. Therefore, **be sure to uncheck the Disable ID/Password checkbox to set an access control to a file.**

## (2) Add ID/Password

Register User IDs/Passwords. It is possible to register 16 User IDs/Passwords. Their IDs and passwords are specified using 1 up to 16 one byte characters (upper and lower cases) or numeric.

By clicking [Add ID/Password] in the ID/Password menu on the left, the following screen will be displayed.

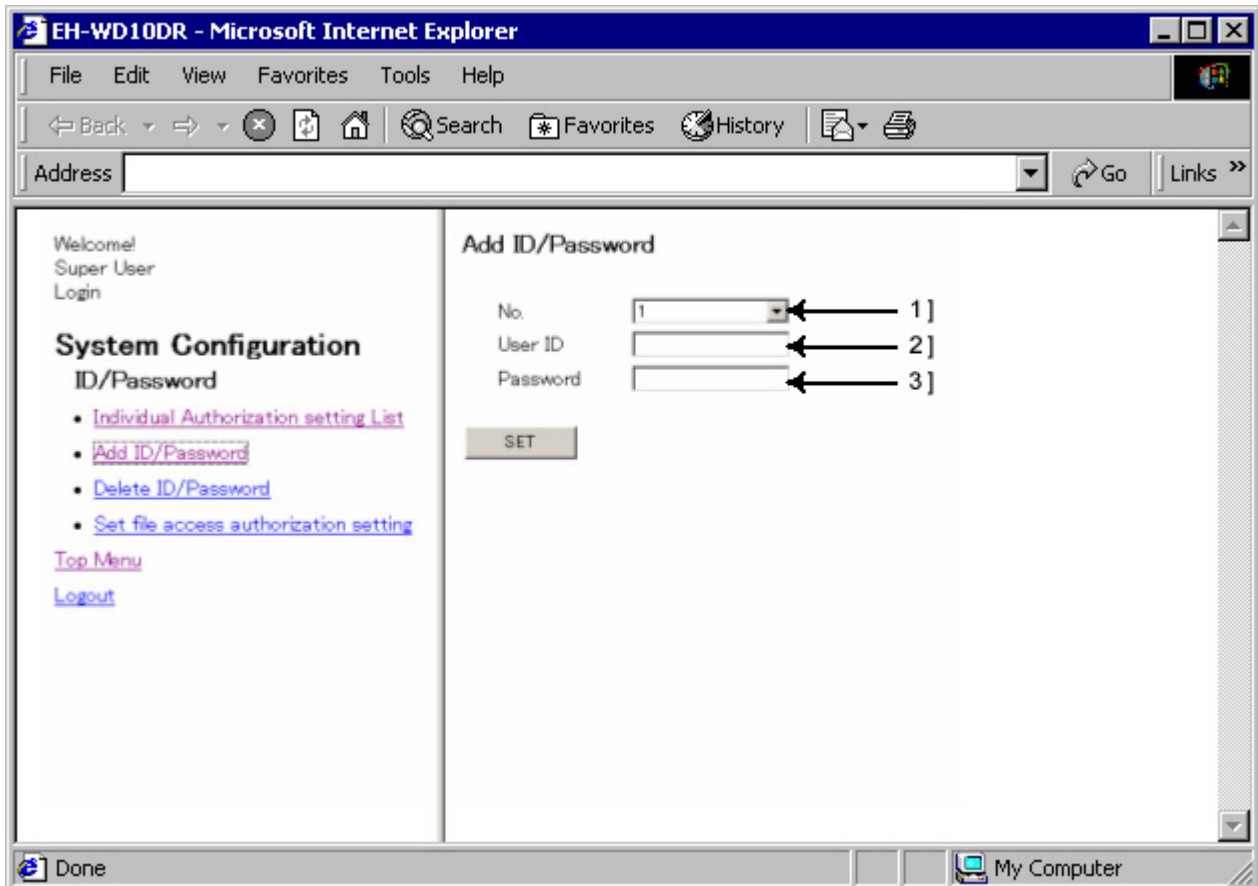

Figure 13.25 ID/Password - Add ID/Password screen

Table 13.23 ID/Password - Add ID/Password screen

No.	Name	Setting Options
1]	No.	Specify a User ID No. A number from 1 to 16 can be specified. Numbers already registered can not be used.
2]	User ID	Input a User ID. 1 up to 16 one byte characters (upper and lower cases) or numeric can be used.
3]	Password	Input a Password for the User ID. 1 up to 16 one byte characters (upper and lower cases) or numeric can be used.



(3) Delete ID/Password

Delete registered User IDs/Passwords.

By clicking [Delete ID/Password] in the ID/Password menu on the left, the following screen will be displayed.

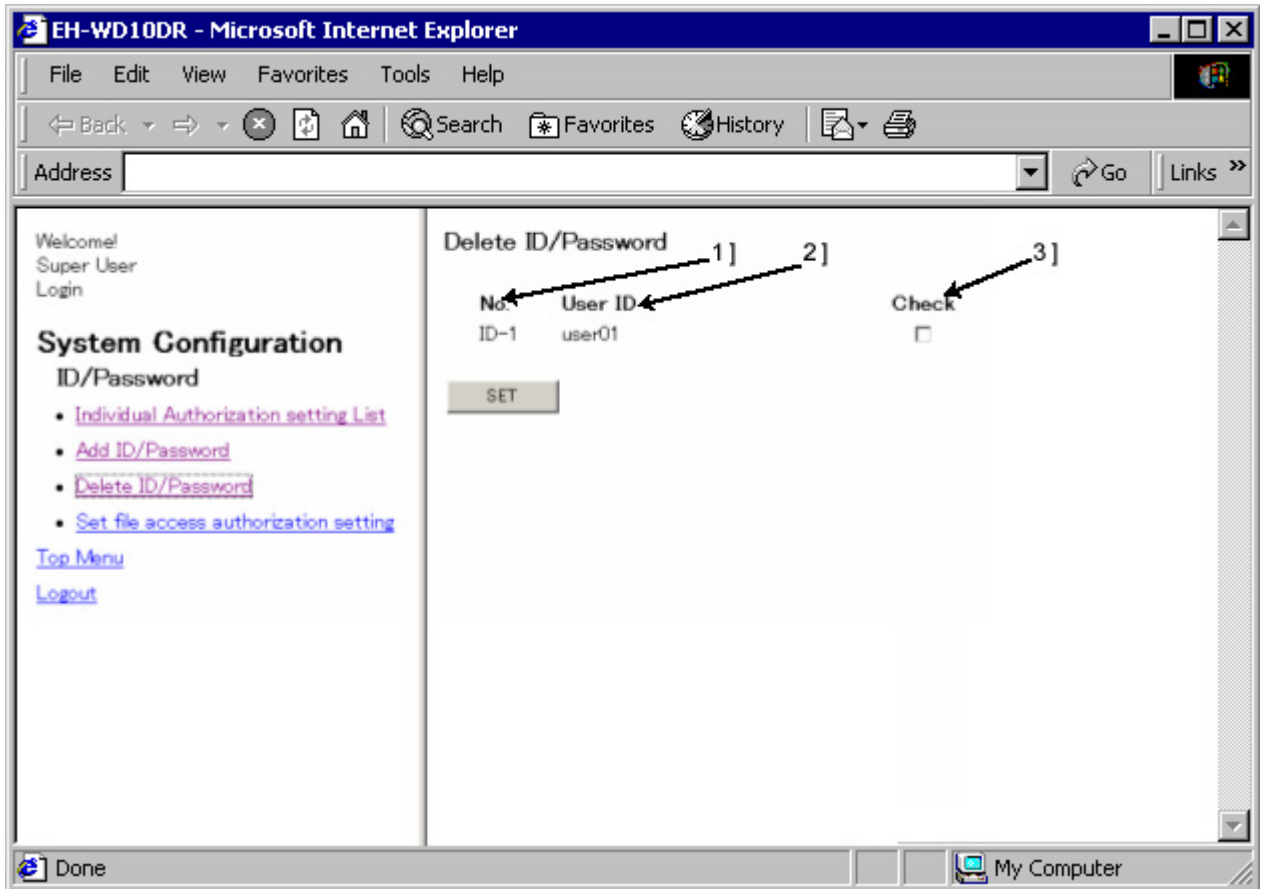

Figure 13.26 ID/Password - Delete ID/Password screen

Table 13.24 ID/Password - Delete ID/Password screen

No.	Name	Setting Options
1]	No.	Displays User ID No.
2]	User ID	Displays User ID. Click this link to view a list of access authorization for each User ID.
3]	Check	Check the checkbox of the ID/Password to delete.

(4) Set file access authorization setting

Set the file access authorization. File access authorization should be set for each file.

By clicking [Set file access authorization setting] in the ID/Password menu on the left, the following screen will be displayed.

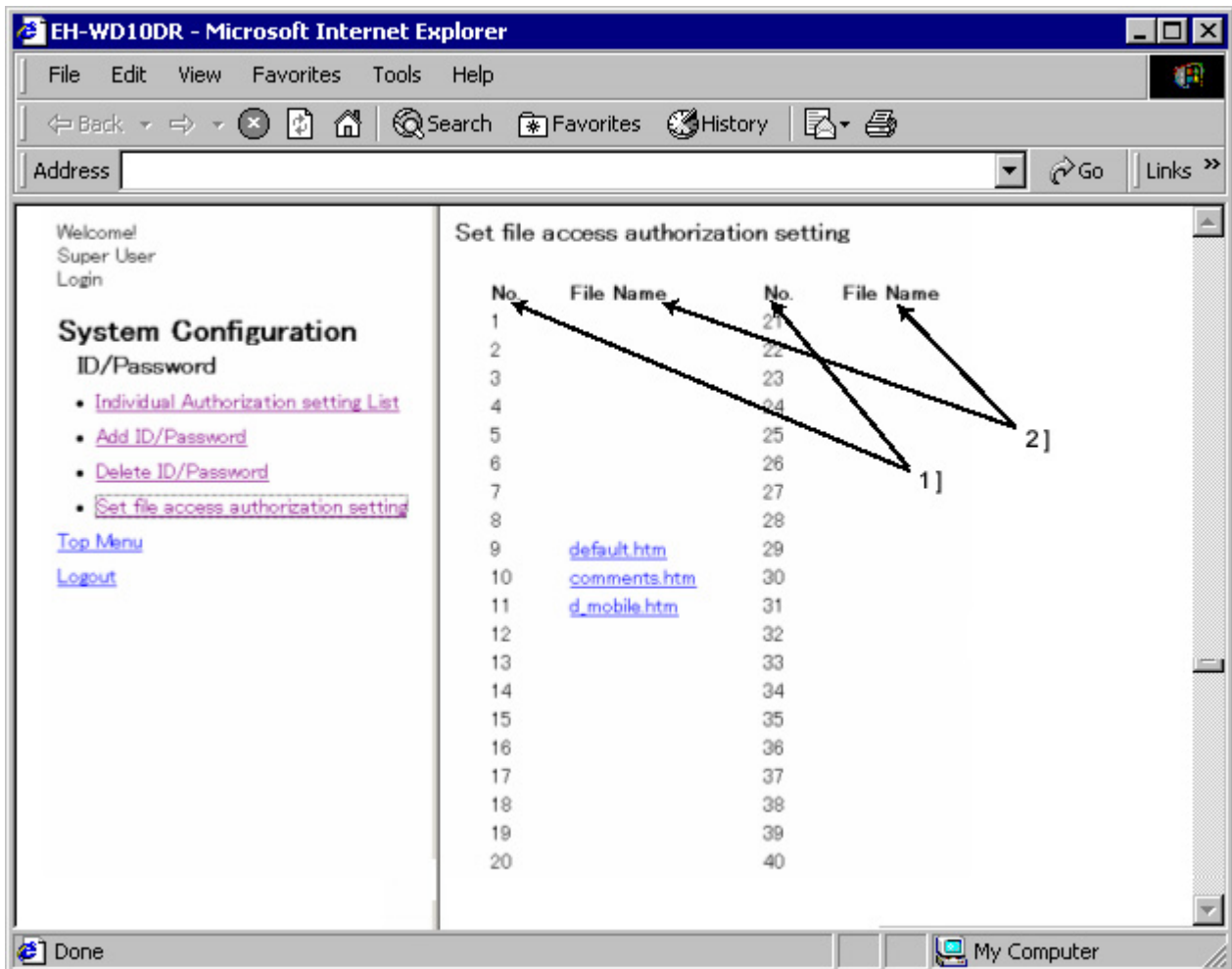

Figure 13.27 ID/Password - Set file access authorization setting screen

Table 13.25 ID/Password - Set file access authorization setting screen

No.	Name	Setting Options
1]	No.	Displays File No.
2]	File Name	Displays File Name. Click this link to view a list of access authorization for each file.

Click the file name on this screen to display the file access authorization of the file.

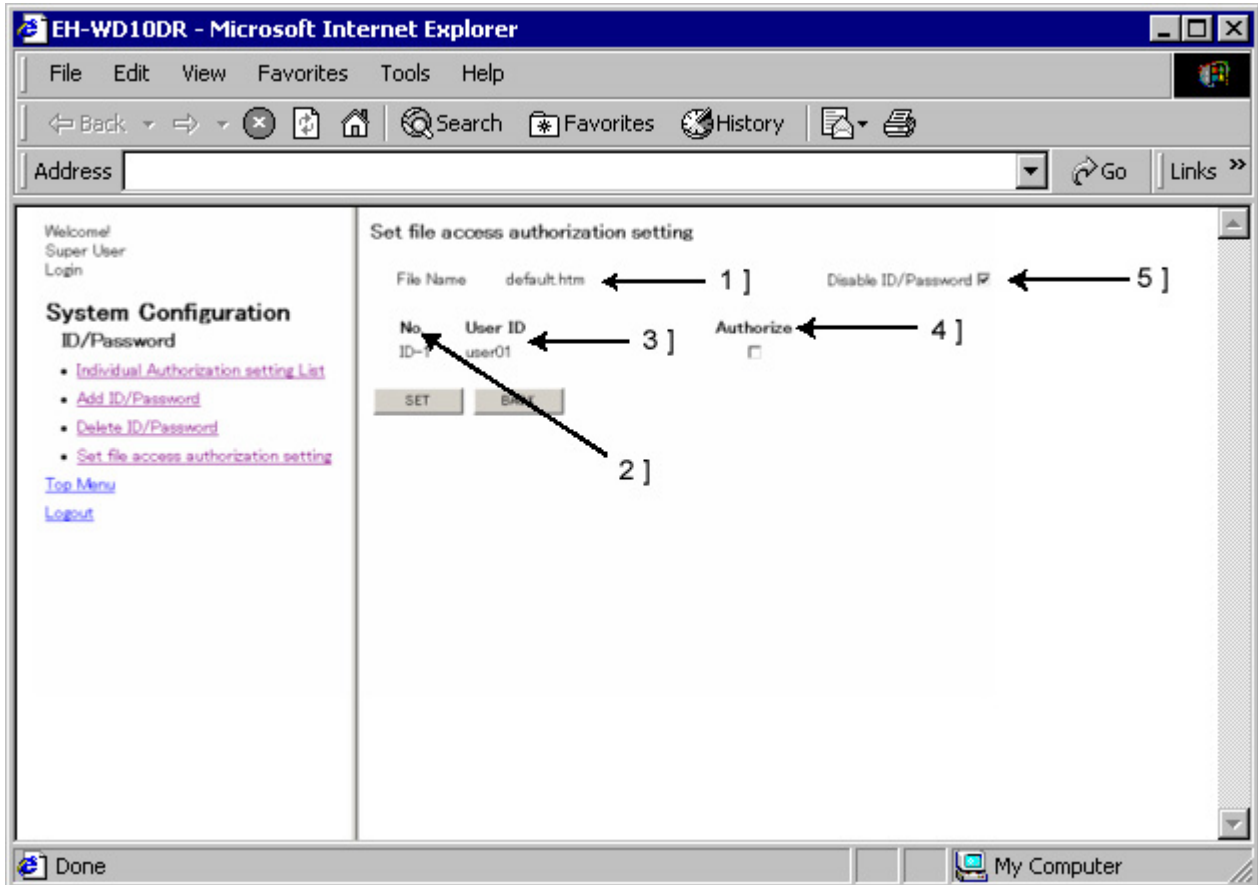

Figure 13.28 ID/Password - Set file access authorization setting screen

Table 13.26 ID/Password - Set file access authorization setting screen

No.	Name	Setting Options
1]	File Name	Displays the name of the file being set.
2]	No.	Displays User ID No.
3]	User ID	Displays User ID.
4]	Authorize	Set the user's access authorization on this file. When "Disable ID/Password" for this file is not checked, the user with this checkbox marked can access this file after his/her ID/Password is authenticated. If this checkbox is not checked, however, the user cannot access this file even after the ID/Password authentication.
5]	Disable ID/Password	Checking this checkbox will allow users to access this file without IDs/Passwords. <b>Be sure to uncheck this box to set an access control to the file.</b>

The following table describes available access authorization setting options.

Table 13.27 ID/Password – List of file access authorization settings

	Disable ID/Password	Authorize	Setting Options
1	X	X	Not accessible even with User ID/Password
2	X	O	Not accessible without User ID/Password
3	O	X	Accessible without User ID/Password
4	O	O	

O: Checked      X: Not checked

### ⚠ Caution!!

Setting of access authorization is not done for each file but is done for each file number. Therefore, the access authorization will be remained even if the file is deleted. The remained access authorization information will be kept for new registered file with same file number.

### 13.1.7 Change password for mail settings

This section describes how to change the password for mail settings.

By clicking [The password setting for mail address] in the System Configuration index screen, the following screen will be displayed.

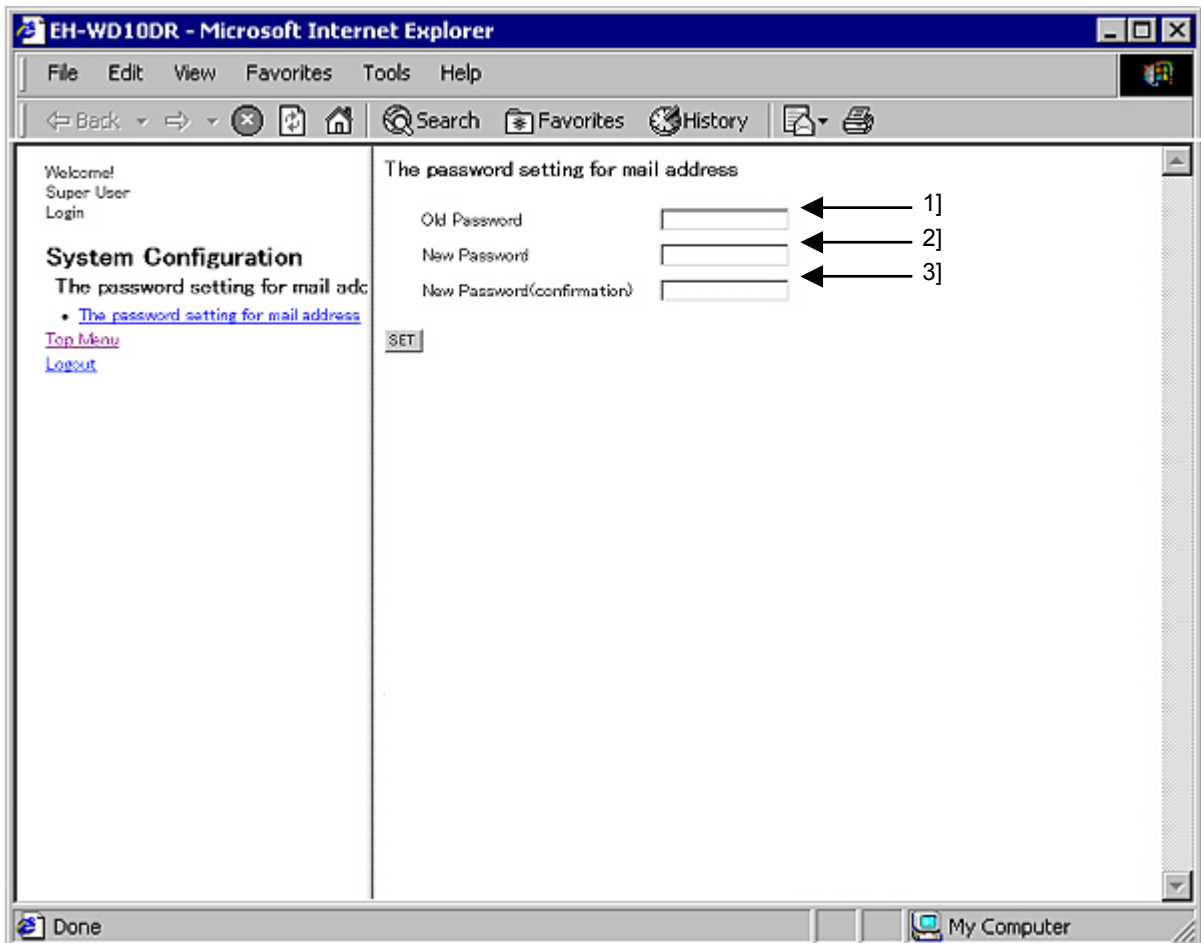

Figure 13.29 Password change screen on mail setting page

Table 13.28 Password change screen on mail setting page

No.	Name	Setting Options
1]	Old Password	Enter the password currently used for the mail settings page.
2]	New Password	Enter a new password for the mail settings page. 1 up to 16 one byte characters (upper and lower cases) or numeric can be used for the password.
3]	New Password (confirmation)	Enter the new password for the mail settings page again for confirmation.

#### **⚠ Caution!!**

Initial password is “1111” for the mail setting. Keeping the password in the initial setting may become a security hole. Therefore, be sure to change the initial password for the mail setting into any others.

### 13.1.8 Change password for I/O Set

This section describes how to change the password for I/O Set.  
 By clicking [I/O Set Password] in the System Configuration index screen, the following screen will be displayed.

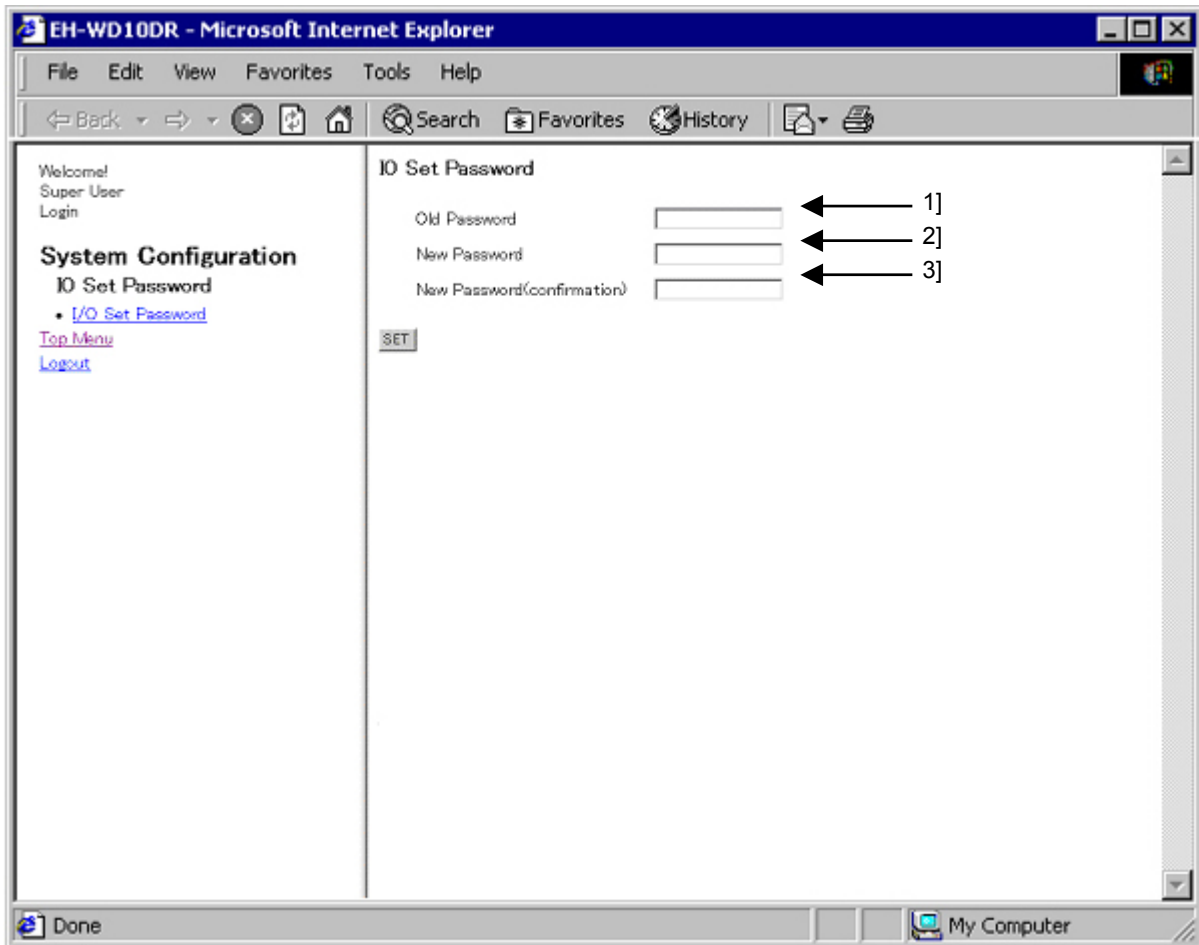

Figure 13.30 I/O Set Password change screen

Table 13.29 I/O Set Password change screen

No.	Name	Setting Options
1]	Old Password	Enter the current password for I/O Set.
2]	New Password	Enter a new password for I/O Set. 1 up to 16 one byte characters (upper and lower cases) or numeric can be used for the password.
3]	New Password (confirmation)	Enter the new password for I/O set again for confirmation.

#### **⚠ Caution!!**

Initial password is “1111” for I/O setting. Keeping the password in the initial setting may become a security hole. Therefore, be sure change the initial password of I/O setting into any others.

## 13.2 23 points type (EH-WA23DR)

### (1) System Configuration index screen

The following screen is displayed after log in to the System Configuration CGI. (This screen is an example for a Super User authorized for all settings in the Super User Registration.) The left part is the “Menu Screen,” and the right part is the “Main Screen.” By clicking the link on the menu screen, corresponding screens will be displayed. The following table describes the contents of the links on the menu screen. The Menu screen displays only the links authorized for the Super User under the configuration in the Super User Registration.

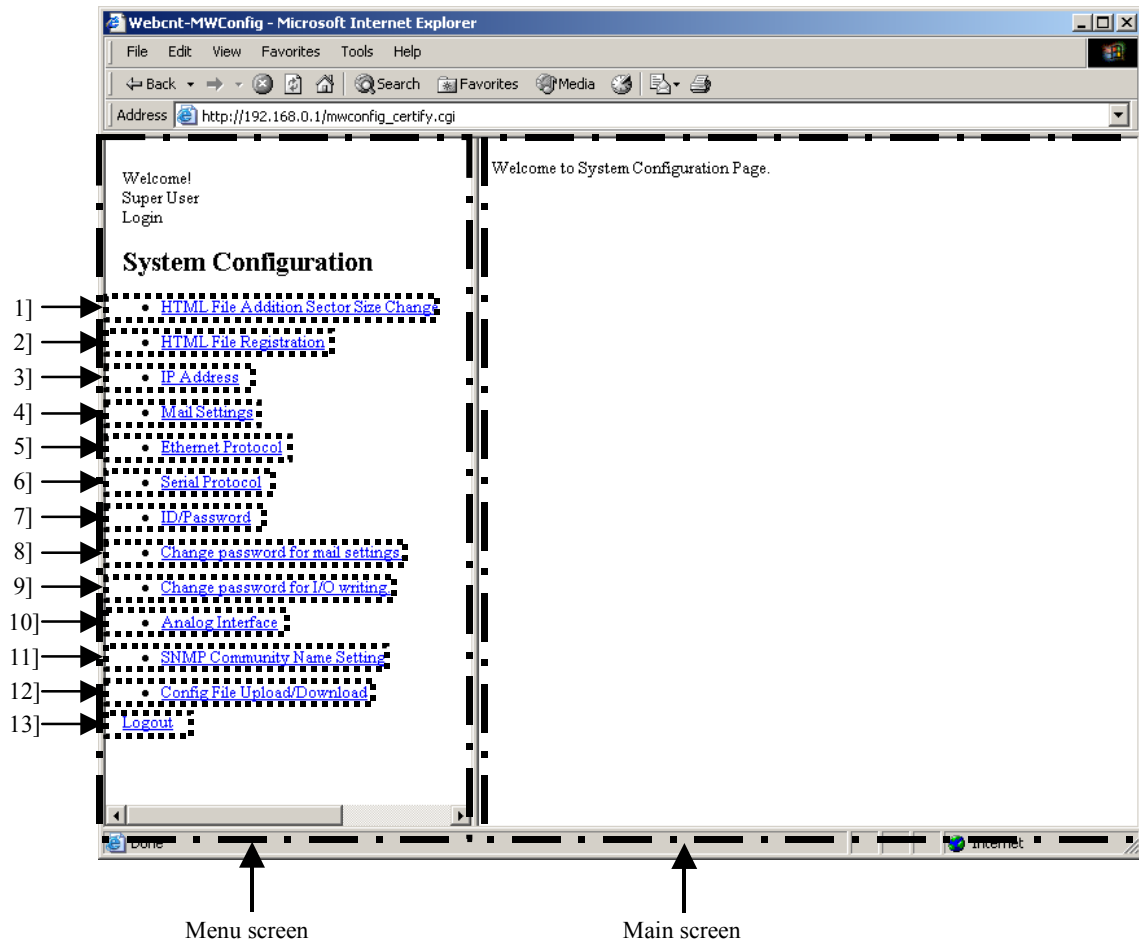

Figure 13.31 System Configuration index screen

Table 13.30 System Configuration index screen

No.	Name	Setting Options	Remarks
1]	HTML File Addition Sector Size Change	Set HTML file registering area size.	*
2]	HTML File Registration	Register, delete and download HTML files.	
3]	IP Address	Set IP addresses, DNS. And NTP.	
4]	Mail Settings	Perform mail settings.	
5]	Ethernet Protocol	Perform Ethernet settings.	
6]	Serial Protocol	Perform serial communication settings.	
7]	ID/Password	Perform ID/Password settings.	
8]	Change password for mail settings	Change the password to log in mail settings function.	
9]	Change password for I/O writing	Change the password for I/O set.	
10]	Analog Interface	Perform analog input/output settings.	*
11]	SNMP Community Name Setting	Perform SNMP settings.	*
12]	Config File Upload/Download	Configuration of Web Controller by using configuration file Upload/Download function.	*
13]	Logout	Logout from the System Configuration.	

\* These functions are supported by 23 points type only. Therefore, there is no setting column in the Authorization Management screen in 10 points type.

### ⚠ Caution !!

The following screen will be displayed when accessing the System Configuration without giving any setting authorization in the Super User Registration. Super Users with no setting authorization is given see this screen. No setting operation can be performed in this screen. Note that the Super User Registration gives no setting authorization as the default.

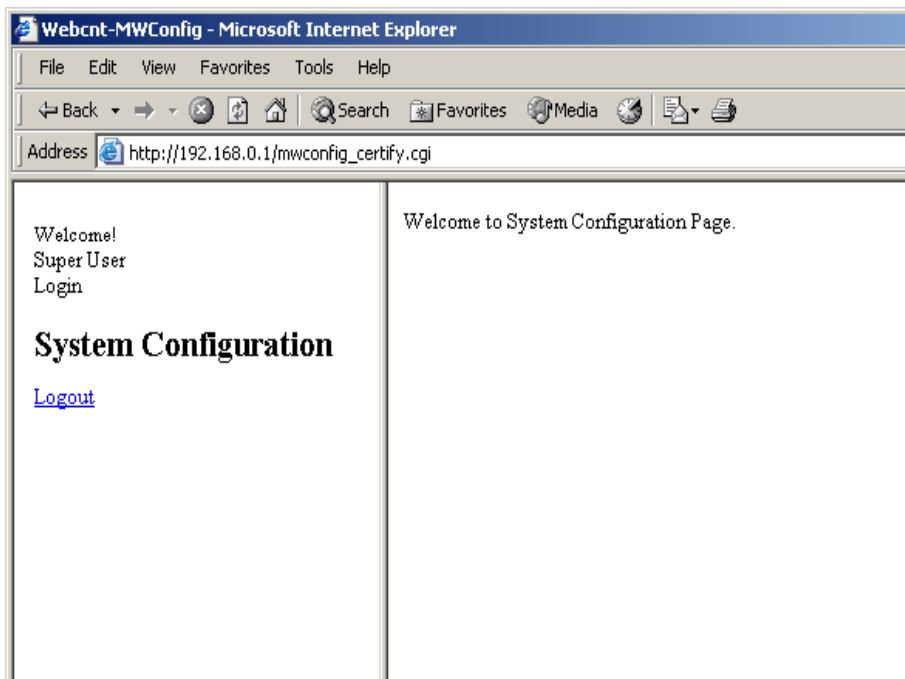

Figure 13.32 System Configuration screen with no setting authorization

### 13.2.1 Web file registration area settings

Set the size of Web file registration area. This function is supported by 23 points type only. By clicking [HTML File Addition Sector Size Change] in the System Configuration index screen, the following screen will be displayed.

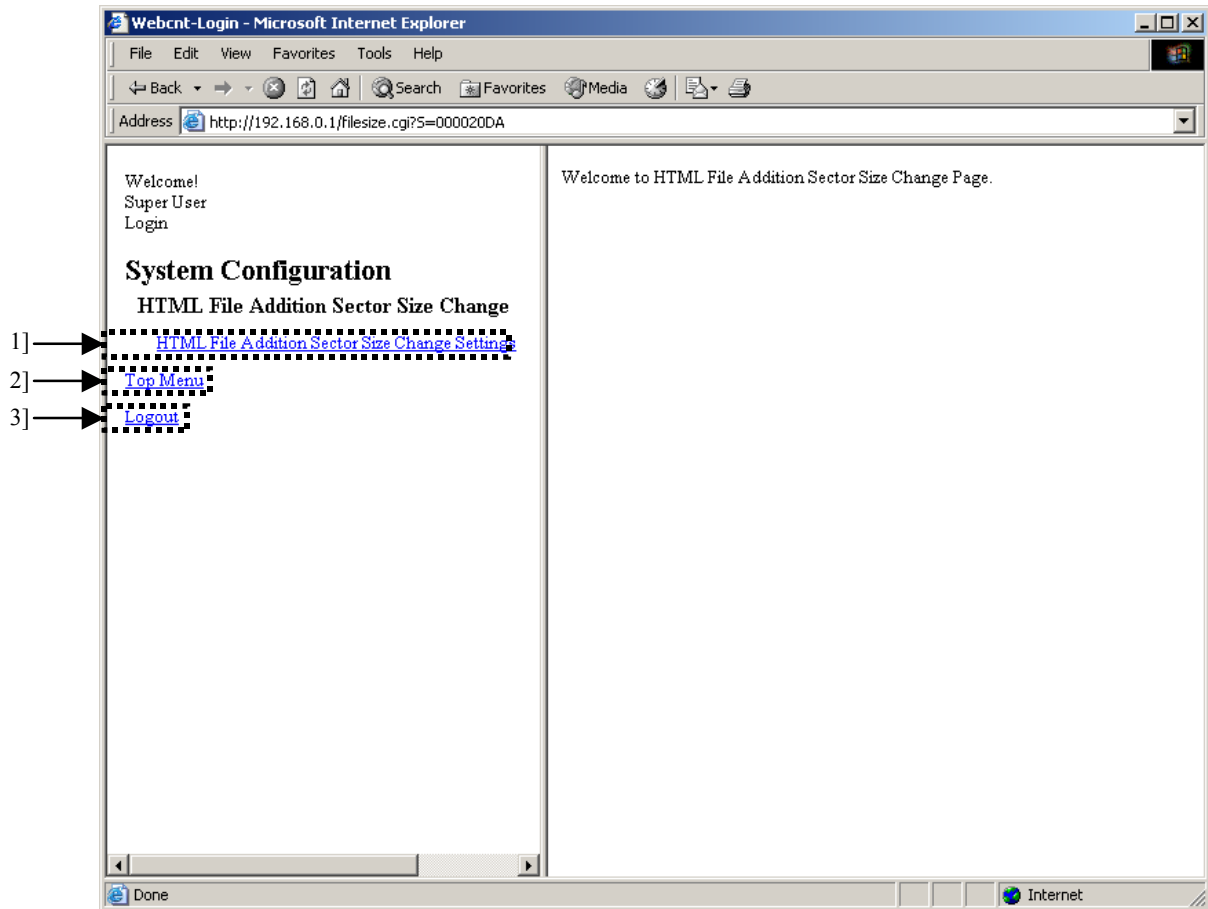

Figure 13.33 HTML File Addition Sector Size Change screen

Table 13.31 HTML File Addition Sector Size Change screen

No.	Name	Setting Options
1]	HTML File Addition Sector Size Change Settings	Set Web file registration area size.
2]	Top Menu	Return to the System Configuration index screen.
3]	Logout	Logout from the System Configuration.



By clicking [HTML File Addition Sector Size Change Settings] in the HTML File Addition Sector Size Change menus on the left, the following screen will be displayed.

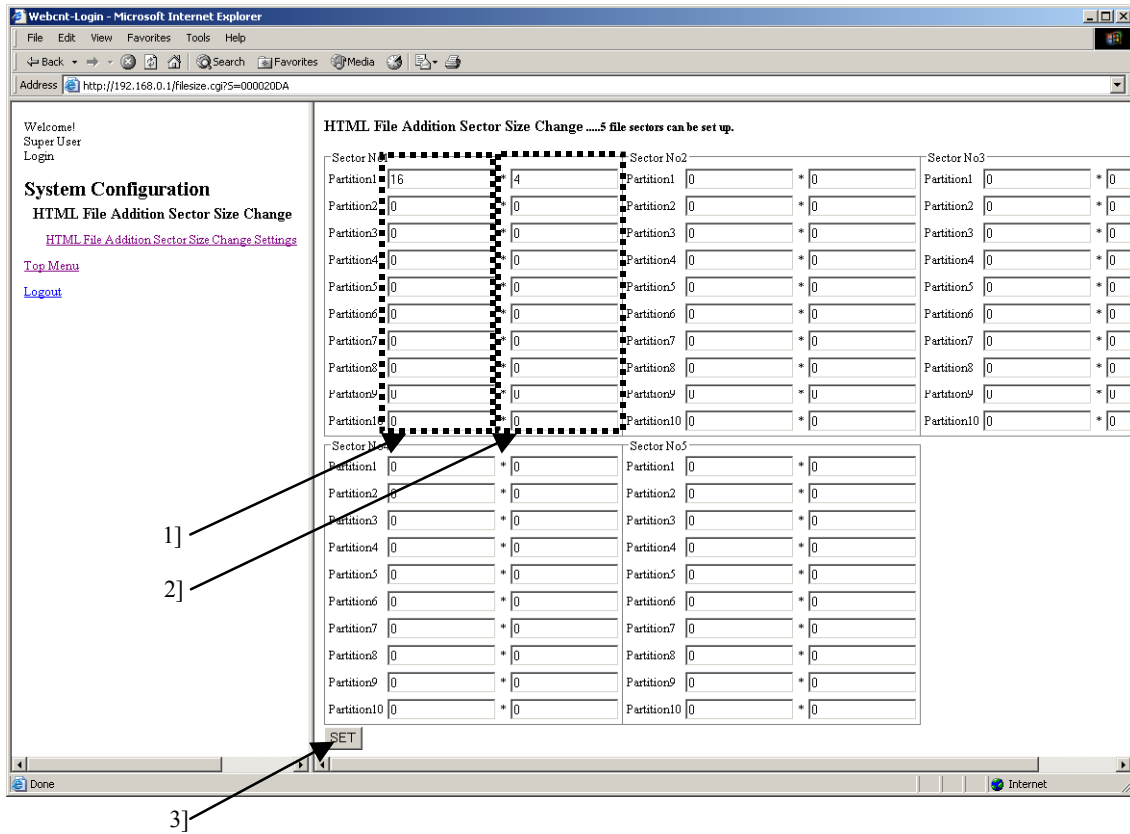

Figure 13.34 HTML File Addition Sector Size Change Settings screen

Table 13.32 HTML File Addition Sector Size Change Settings screen

No.	Name	Setting Options
1]	Size of Web file registering area	Specify the size of Web file registration area by k byte.
2]	Number	Specify the number of area generated by size specified at 1].
3]	Set button	Create Web file registration area. By clicking this button, move to [HTML File Addition Sector Size Change Settings confirmation screen].

**⚠ Caution!!**

It is not allow to specify more than 64 k bytes for one sector. Error screen will be displayed when setting is more than 64 k bytes.

[Example 1]

HTML File Addition Sector Size Change .....5 file sectors can be set up.

Sector No1			Sector No2			Sector No3		
Partition1	16	* 4	Partition1	0	* 0	Partition1	0	* 0
Partition2	0	* 0	Partition2	0	* 0	Partition2	0	* 0
Partition3	0	* 0	Partition3	0	* 0	Partition3	0	* 0
Partition4	0	* 0	Partition4	0	* 0	Partition4	0	* 0
Partition5	0	* 0	Partition5	0	* 0	Partition5	0	* 0
Partition6	0	* 0	Partition6	0	* 0	Partition6	0	* 0
Partition7	0	* 0	Partition7	0	* 0	Partition7	0	* 0
Partition8	0	* 0	Partition8	0	* 0	Partition8	0	* 0
Partition9	0	* 0	Partition9	0	* 0	Partition9	0	* 0
Partition10	0	* 0	Partition10	0	* 0	Partition10	0	* 0
Sector No4			Sector No5					
Partition1	0	* 0	Partition1	0	* 0			
Partition2	0	* 0	Partition2	0	* 0			
Partition3	0	* 0	Partition3	0	* 0			
Partition4	0	* 0	Partition4	0	* 0			
Partition5	0	* 0	Partition5	0	* 0			
Partition6	0	* 0	Partition6	0	* 0			
Partition7	0	* 0	Partition7	0	* 0			
Partition8	0	* 0	Partition8	0	* 0			
Partition9	0	* 0	Partition9	0	* 0			
Partition10	0	* 0	Partition10	0	* 0			

SET

Figure 3.35 Example 1 for HTML File Addition Sector Size Change Settings

The above setting means that four 16 k bytes-registration area are created in the sector No.1 and no registration area is created in other sectors.

In this case, these registration areas are from file No.1 to file No.4. A file up to 16 k bytes can be stored in each file.

[Example 2]

**HTML File Addition Sector Size Change .....5 file sectors can be set up.**

Sector No1			Sector No2			Sector No3		
Partition1	16	* 1	Partition1	16	* 4	Partition1	8	* 8
Partition2	0	* 0	Partition2	0	* 0	Partition2	0	* 0
Partition3	0	* 0	Partition3	0	* 0	Partition3	0	* 0
Partition4	0	* 0	Partition4	0	* 0	Partition4	0	* 0
Partition5	0	* 0	Partition5	0	* 0	Partition5	0	* 0
Partition6	0	* 0	Partition6	0	* 0	Partition6	0	* 0
Partition7	0	* 0	Partition7	0	* 0	Partition7	0	* 0
Partition8	0	* 0	Partition8	0	* 0	Partition8	0	* 0
Partition9	0	* 0	Partition9	0	* 0	Partition9	0	* 0
Partition10	0	* 0	Partition10	0	* 0	Partition10	0	* 0

Sector No4			Sector No5		
Partition1	4	* 16	Partition1	1	* 64
Partition2	0	* 0	Partition2	0	* 0
Partition3	0	* 0	Partition3	0	* 0
Partition4	0	* 0	Partition4	0	* 0
Partition5	0	* 0	Partition5	0	* 0
Partition6	0	* 0	Partition6	0	* 0
Partition7	0	* 0	Partition7	0	* 0
Partition8	0	* 0	Partition8	0	* 0
Partition9	0	* 0	Partition9	0	* 0
Partition10	0	* 0	Partition10	0	* 0

SET

Figure 3.36 Example 2 for HTML File Addition Sector Size Change Settings

The above setting means the following things. One 16k bytes-registration area, two 8k bytes-registration areas, four 4k bytes-registration areas and eight 2k bytes-registration areas are created in the sector No.1 and four 16k byte-registration areas are created in the sector No.2 and eight 8k bytes-registration areas are created in the sector No.3 and sixteen 4k bytes-registration areas are created in the sector No.4 and 64 1k byte-registration areas are created in the sector No.5.

The following table describes the file number of registration areas in this case.

Table 13.33 File number in Example 2 for HTML File Addition Sector Size Change Settings

File No.	Area size (k byte)
1	16 k bytes
2 to 3	8 k bytes
4 to 7	4 k bytes
8 to 15	2 k bytes
16 to 19	16 k bytes
20 to 27	8 k bytes
28 to 43	4 k bytes
44 to 107	1 k byte

By clicking [SET] in the HTML File Addition Sector Size Change Settings screen, the following screen will be displayed if there is no mistake in the setting. The settings are checked on this screen.

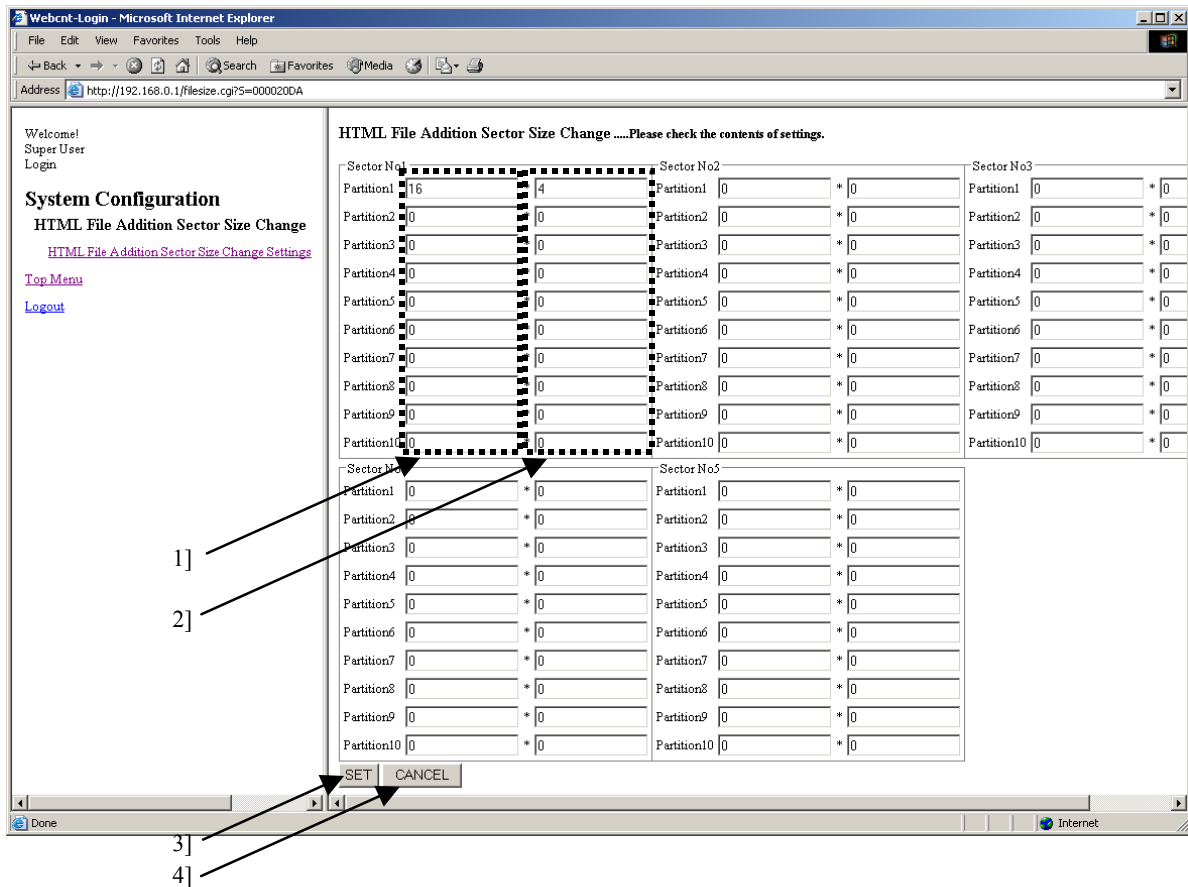

Figure 3.37 HTML File Addition Sector Size Change Settings confirmation screen

Table 3.34 HTML File Addition Sector Size Change Settings confirmation screen

No.	Name	Setting Options
1]	Web File Registration Area Size	Size of the set Web file registration area is displayed.
2]	Numbers	The numbers of the set Web file registration area is displayed.
3]	Set Button	Create Web file registration area.
4]	Cancel	The settings are canceled and Web file registration area is not created. The previous settings are held. Move to the HTML File Addition Sector Size Change Settings screen.

### ⚠ Caution!!

Note that all files stored in Web Controller are deleted by this operation.

Therefore, be sure to create backup files of necessary Web files stored in Web Controller before this operation.

### 13.2.2 Web Files Registration

This section describes how to store files in Web Controller, delete the stored file, and download the stored files from Web Controller.

By clicking [HTML File Registration] in the System Configuration index screen, the following screen will be displayed.

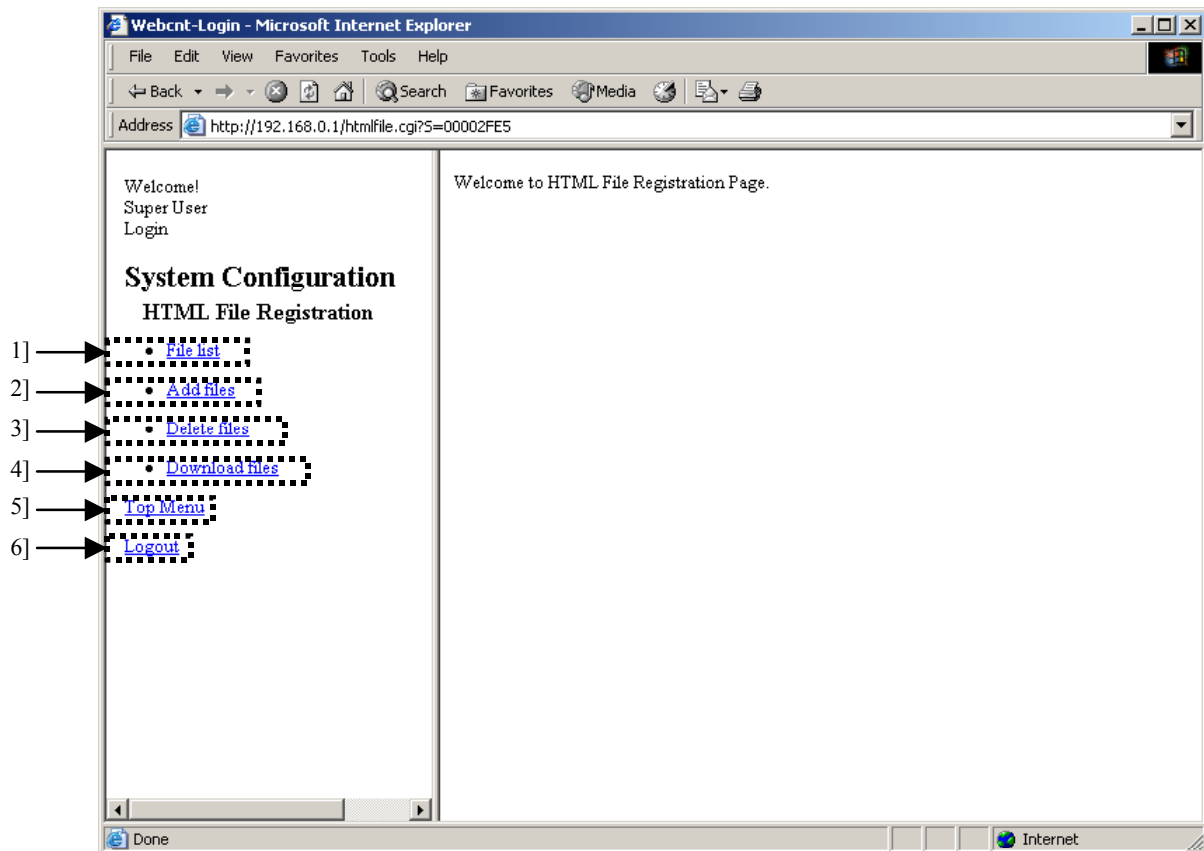

Figure 13.38 HTML File Registration Menu screen

Table 13.35 HTML File Registration Menu screen

No.	Name	Setting Options
1]	File list	Displays the list of files stored in Web Controller.
2]	Add files	Stores files in Web Controller.
3]	Delete files	Deletes files stored in Web Controller.
4]	Download files	Downloads files stored in Web Controller.
5]	Top Menu	Returns to the System Configuration index menu screen.
6]	Logout	Logouts from the System Configuration.

The following files can be registered in Web Controller. Three files of "default.htm", "comments.htm" and "d\_mobile.htm" are registered as factory setting.

Table 13.36 File registration specification (23 points type)

Item	Description
Storable file types	HTML(*.htm, *.html), Cascading StyleSheet(*.css), JavaScript(*.js), JPEG(*.jpg, *.jpeg, *.jpe), GIF(*.gif), BMP(*.gmp), WAV(*.wav, *.wave), Java Applet(*.class), Shockwave Flash(*.swf)
File names	1] Number of characters Up to 15 characters including extension 2] Usable characters "A to Z", "a to z", "0 to 9", "-", "_" 3] Same file names can not be registered.
Storable file size and number of files	64k bytes sector x 5 (Total size is 320k bytes) It is possible to separate the 64k bytes sector into some size with 1k byte unit by user's definition. Therefore, maximum number of storable files will be 320 files. (Total size 320 k bytes / 1k byte = 320 files)

The configuration of Web file registration area is required in 23 points type. It is possible to separate the 64k bytes sector into some size with 1k byte unit by user's definition. This configuration should be done using the System Configuration page.

HTML files to be registered in Web Controller may be freely created as Web pages with HTML tags and scripts. Web Controller supports HTML tags adopted in Microsoft Internet Explorer ("IE") 6.0 later versions.

(1) File list

Displays the list of files stored in Web Controller.

By clicking [File list] in the HTML File Registration menus on the left, the following screen will be displayed.

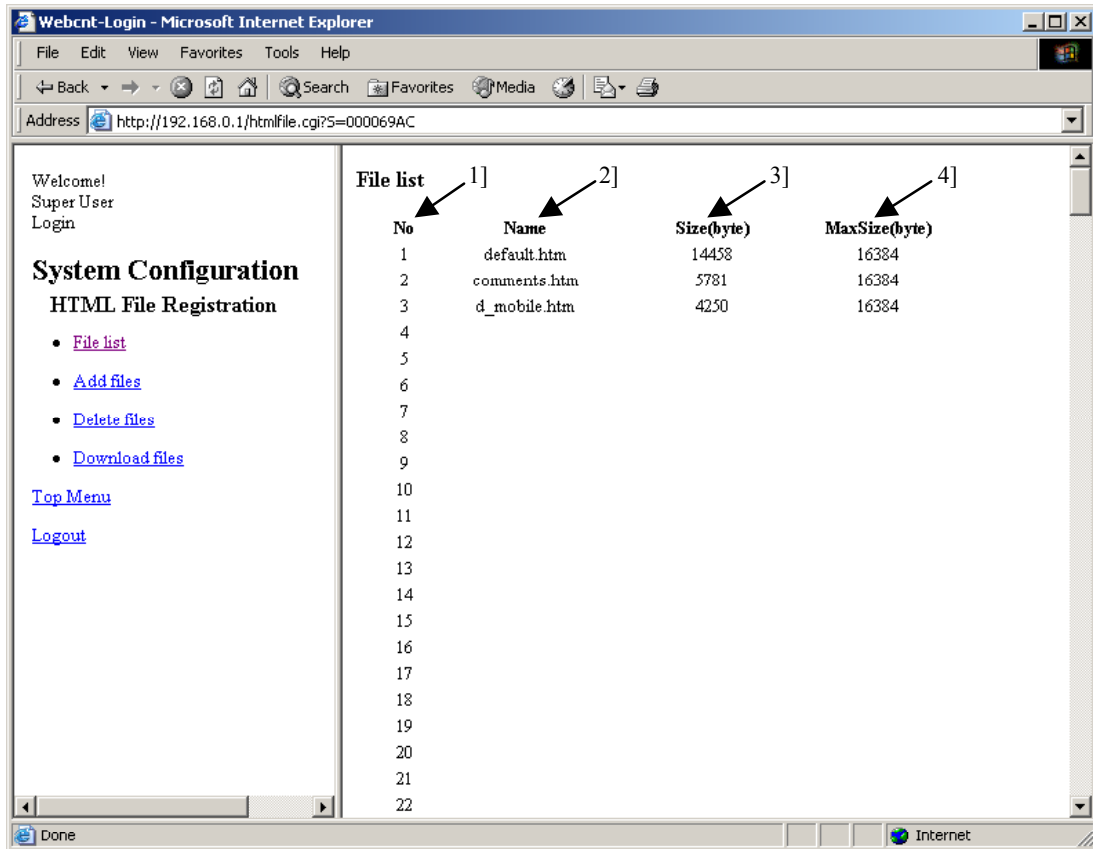

Figure 13.39 HTML File Registration – File list screen

Table 13.37 HTML File Registration – File list screen

No.	Name	Setting Options
1]	No.	File number for the stored file. Selects a number when storing a file. Note that size of the storable file varies depending on the file number. Refer to table 13.36 in the previous page for the size of the storable file.
2]	Name	File name of the stored file.
3]	Size(byte)	File size of the stored file.
4]	MaxSize(byte)	Maximum size of the storable file under the file number. Note that the file size varies depending on the file number. Refer to table 13.36 in the previous page for the size of the storable file.

## (2) Add files

Stores files in Web Controller.

By clicking [Add files] in the HTML File Registration menus on the left, the following screen will be displayed.

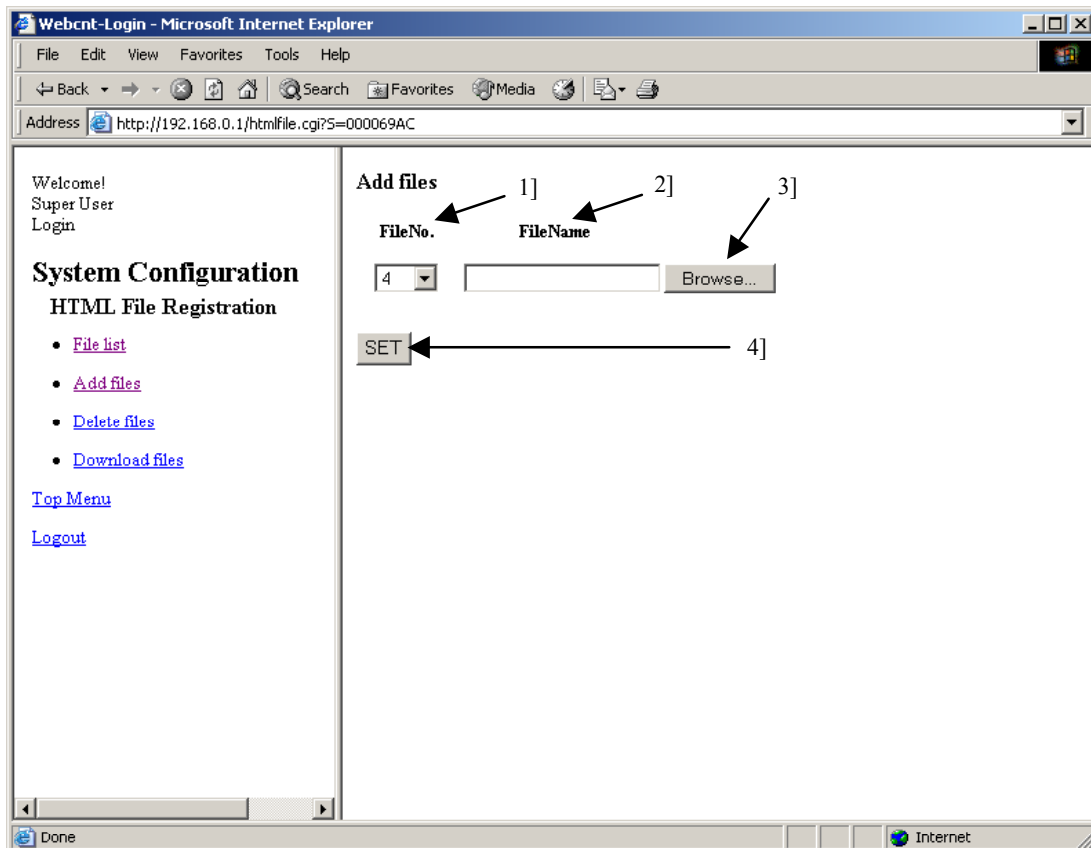

Figure 13.40 HTML File Registration – Add files screen

Table 13.38 HTML File Registration – Add files screen

No.	Name	Setting Options
1]	FileNo.	Selects a file number. File number of which no file is stored can be selected.
2]	FileName	Inputs a path of the file name. Click the [Reference...] button (3]) to display GUI for file options.
3]	[Reference...] button	Click this button to display GUI to select a file to store. Select a file, and the path of the file will appear in the FileName box (2]).
4]	SET	Click this button to store the specified file.

### ⚠ Caution!!

Setting of access authorization is not done for each file but is done for each file number. Therefore, the access authorization will be remained even if the file is deleted. The remained access authorization information will be kept for new registered file with same file number.



(3) Delete files

Deletes files stored in Web Controller.

By clicking [Delete files] in the HTML File Registration menus on the left, the following screen will be displayed.

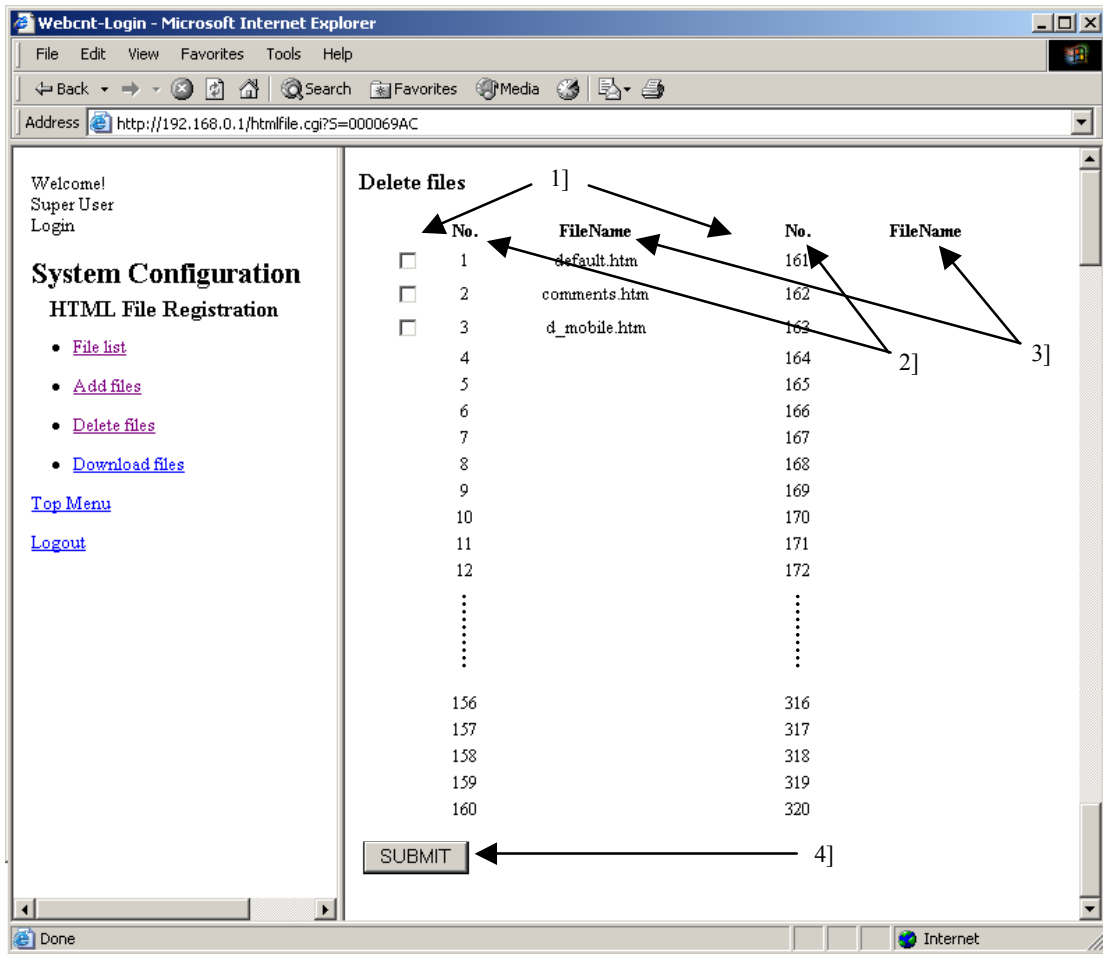

Figure 13.41 HTML File Registration – Delete files screen

Table 13.39 HTML File Registration – Delete files screen

No.	Name	Setting Options
1]	Check box	Check the check box of the file to delete.
2]	No.	File number for the stored file.
3]	FileName	Name of the stored file.
4]	SUBMIT	Click this button to delete the file of which check boxes are checked.

**⚠ Caution!!**

Setting access authorization is not done for each file but is done for each file number. Therefore, the access authorization will be remained even if the file is deleted. The remained access authorization information will be kept for new registered file with same file number.

## (4) Download files

Downloads files stored in Web Controller.

By clicking [Download files] in the HTML File Registration menus on the left, the following screen will be displayed.

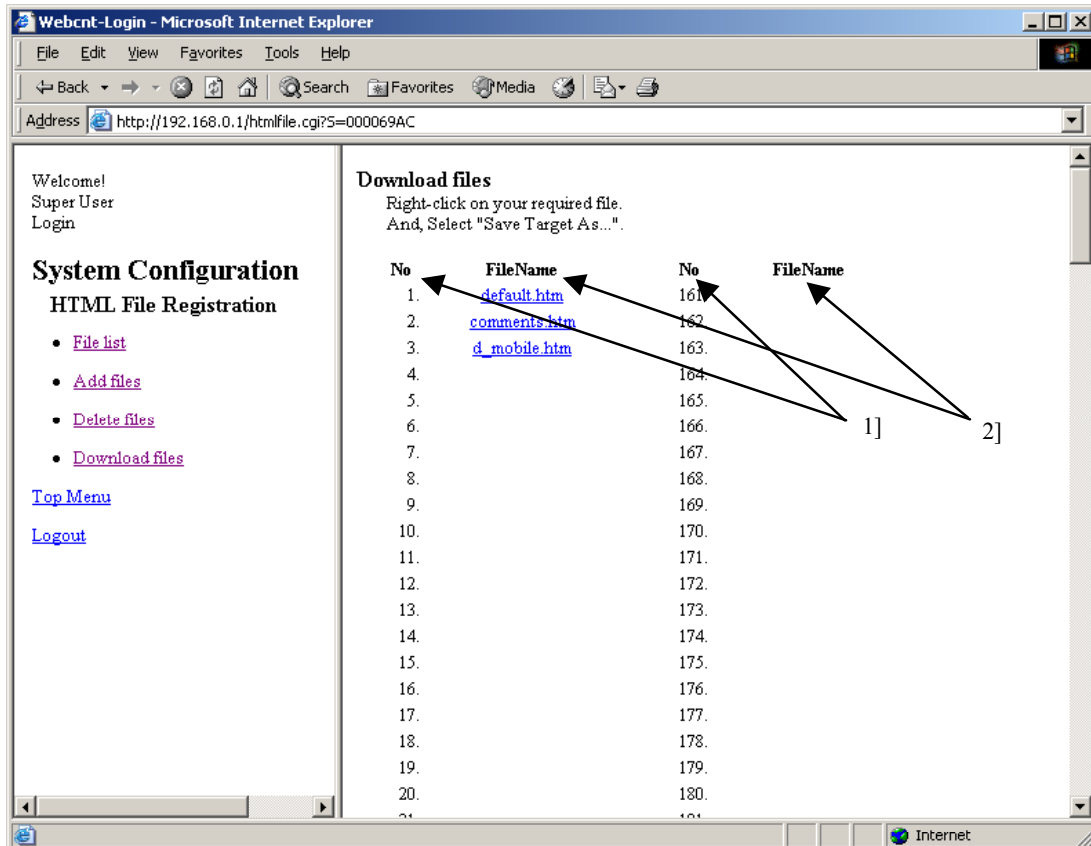

Figure 13.42 HTML File Registration – Download files screen

Table 13.40 HTML File Registration – Download files screen

No.	Name	Setting Options
1]	No.	File number for the stored file.
2]	FileName	<p>Name of the stored file.</p> <p>Each FileName is a link to the file stored with the name. <b>To download a file, place the cursor over the link, select [Save Target in] from the right-click menu, and specify a folder to store the file and the file name.</b></p> <p>By clicking this link, descriptions of the file are displayed in the Download files main screen on the right. Note that this operation will not convert the extension tag to the data on data memory;</p>

### 13.2.3 IP Address Registration

This section describes how to perform settings of the IP address, DNS and NTP for Web Controller. By clicking [IP Address] in the System Configuration index screen, the following screen will be displayed.

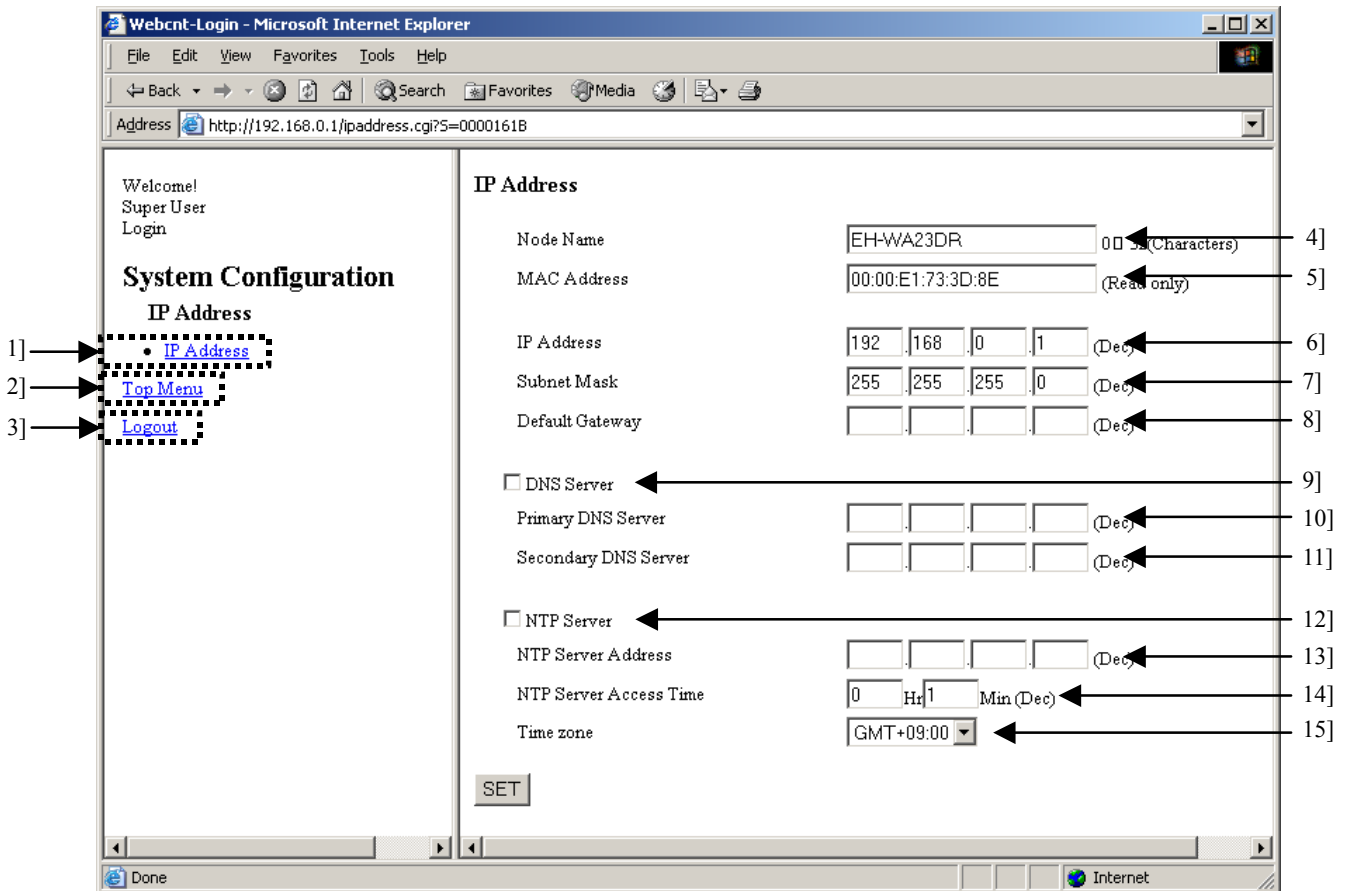

Figure 13.43 IP Address setting screen

Table 13.41 IP Address setting screen

No.	Name	Setting Options
1]	IP Address	Display the IP Address setting screen again in the Main screen on the right. Use this menu to read out the current status while processing the setting.
2]	Top Menu	Return to the System Configuration index screen.
3]	Logout	Logout from the System Configuration.
4]	Node Name	Input the node name. Specify using 0 to 32 one-byte characters.
5]	MAC Address	Display the MAC address set to Web Controller. (Read only)
6]	IP Address	Input the IP address of Web Controller.
7]	Subnet Mask	Input the subnet mask of a network group in which Web Controller resides.
8]	Default Gateway	Input the default gateway of a network group in which Web Controller resides.
9]	DNS Server	Specify if DNS server is used or not. Check the check box to use the server. <b>Be sure to set the DNS server if POP and SMTP servers are specified by domain names for sending e-mails.</b>
10]	Primary DNS Server	Input the IP address of Primary DNS server.
11]	Secondary DNS Server	Input the IP address of Secondary DNS server.
12]	NTP Server	Set whether or not to access NTP server to update the current time. Check the check box to update the current time.
13]	NTP Server Address	Input the IP address of NTP server to be access from Web Controller.
14]	NTP Server Access Time	Input the interval time of the access to NTP server from Web Controller. Input from 0 to 99 [Hr] and from 0 to 59 [Min].
15]	NTP Server Time Zone	Select the time zone. Default is the Japan Standard Time. (GMT +09:00). Note that this function does not support Daylight Saving Time.

Complete the IP address and other settings, and click the [SET] button. By clicking the button, the following screen will be displayed if all the data is property set. Click the [OK] button on this screen, and Web Controller reboots. Then, the OK LED on Web Controller will blink for several seconds. When the blinking stops and the OK LED lights up again, reboot process is complete, and settings including the IP address is reflected in Web Controller.

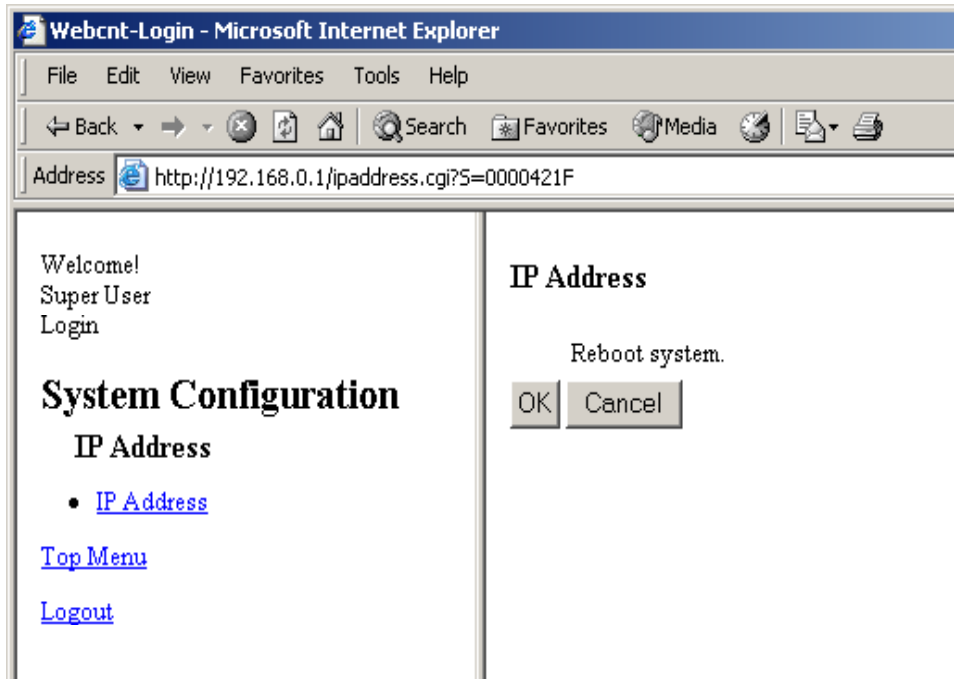

Figure 13.44 Reboot confirmation screen

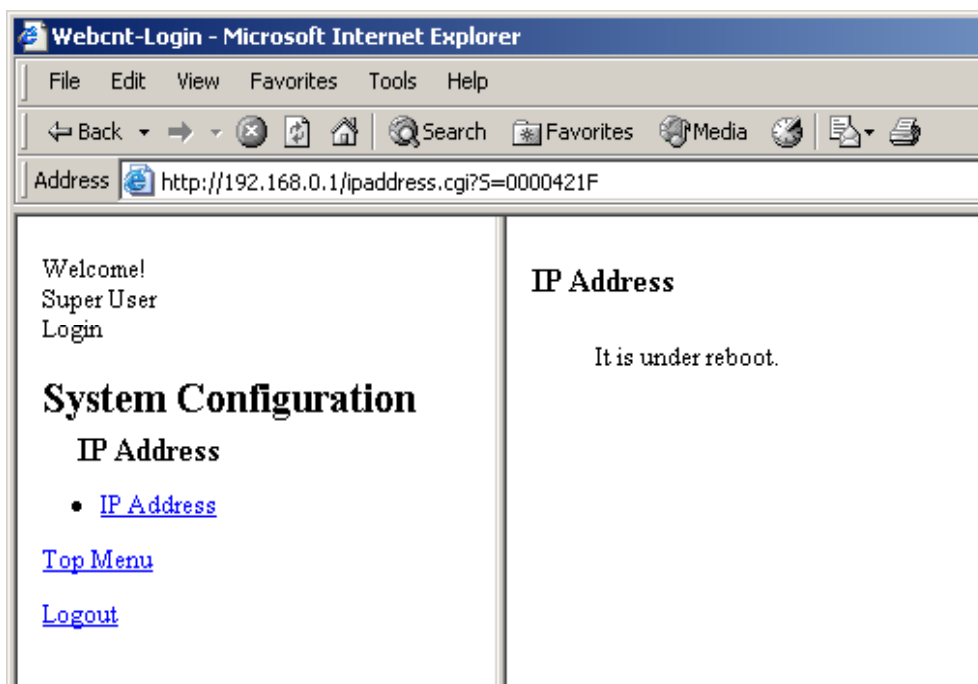

Figure 13.45 Reboot screen

### ⚠ Caution!!

Note that Web Controller must be restarted to reflect changes to IP address. Be sure to go through the restarting process using this function to restart, but never shut off and re-supply the power for the purpose.

### 13.2.4 Mail Settings

This section describes how to perform e-mail settings on Web Controller. By clicking [Mail Settings] in the System Configuration index screen, the following screen will be displayed.

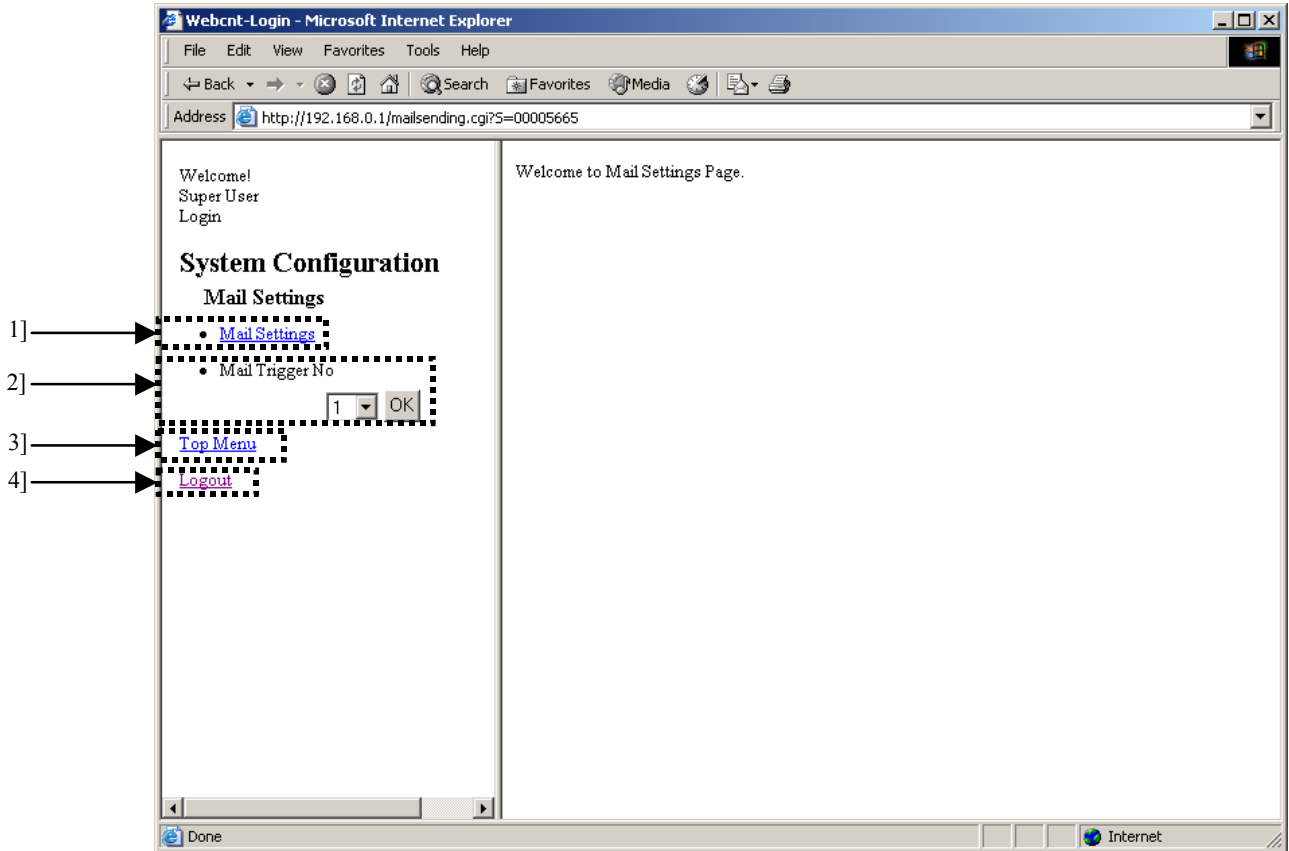

Figure 13.46 Mail Settings menu screen

Table 13.42 Mail Settings menu screen

No.	Name	Setting Options
1]	Mail Settings	Display the e-mail basic setting screen.
2]	Mail Trigger No.	Select a trigger number from No.1 to No.16 from the pull-down menu, and flick the [OK] button to view the e-mail trigger settings screen for each trigger number.
3]	Top Menu	Return to the System Configuration index menu.
4]	Logout	Logout form the System Configuration.

## (1) E-mail basic settings

This section describes how to perform basic settings for e-mails sending on Web Controller.

By clicking [Mail Settings] in the Mail Settings menu on the left, the following screen will be displayed.

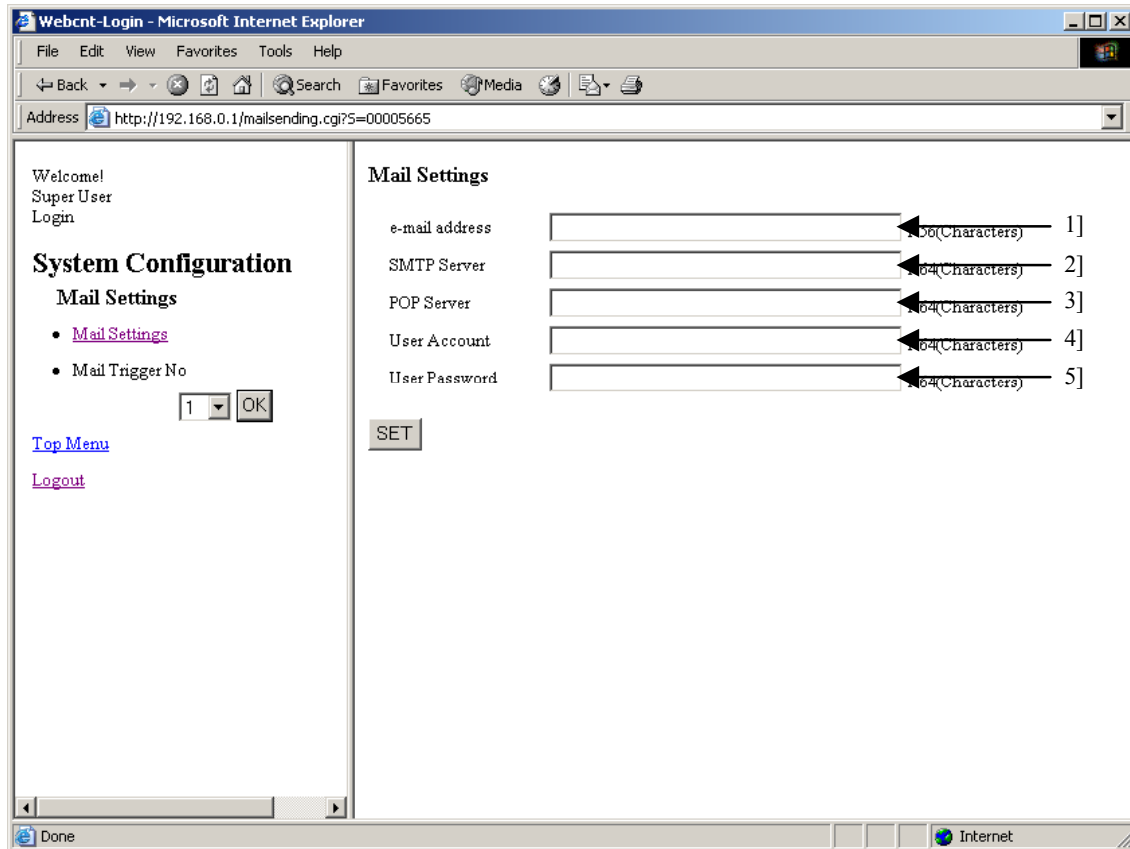

Figure 13.47 Mail Settings – basic setting screen

Table 13.43 Mail Settings – basic setting screen

No.	Name	Setting Options
1]	e-mail address	Input an e-mail address to be used as a sender of e-mails.
2]	SMTP Server	Input the address of SMTP server. <b>Be sure to set the DNS server on the IP Address setting screen when specifying the SMTP server using domain names.</b>
3]	POP Server	Input the address of POP server. <b>Be sure to set the DNS server on the IP Address setting screen when specifying the POP server using domain names.</b>
4]	User Account	Input the user account for POP authentication.
5]	User Password	Input the password of user account for POP authentications.

(2) E-mail trigger settings

This section describes how to set triggers for sending e-mail and e-mail contents on Web Controller.

By selecting a trigger number to set from the pull-down menu in the Mail Settings menu on the left, and click the [OK] button, the following screen will be displayed (this is an example screen for Trigger No.1). Trigger number from No.1 to 16 can be used.

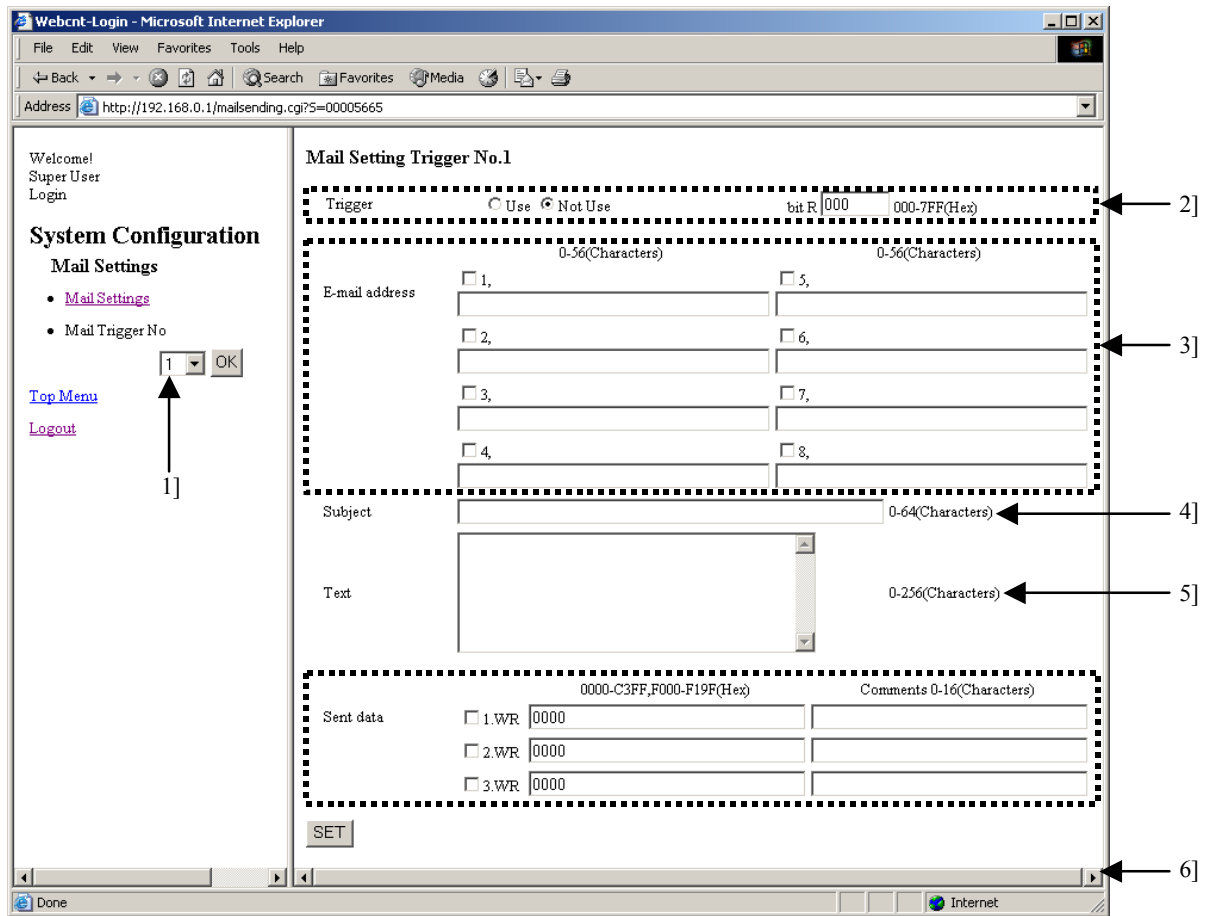

Figure 13.48 Mail Settings – Trigger setting screen

Table 13.44 Mail Settings – Trigger setting screen

No.	Name	Setting Options
1]	Mail Trigger No.	Select a trigger number to be used for sending e-mails. (Description of the selected trigger is indicated in 4].) Up to 16 triggers can be set.
2]	Trigger	Setting of the e-mail send triggers. Select “Use” or “Not Use” for each trigger. If you select “Use”, select a bit internal output from “R” to be used as the trigger and input it.
3]	E-mail address	Input destinations of outgoing e-mails. Up to 8 destinations can be set for each trigger.
4]	Subject	Input a subject of the outgoing e-mail. Up to 64 one-byte characters or 32 double-bytes characters can be used. *
5]	Text	Input a text of the outgoing e-mail. Up to 256 one-byte characters or 128 double-bytes characters can be used. *
6]	Sent Data	Internal output data can be added to the e-mail text a maximum of 3 words. Also, a comment can be added for each word. Up to 16 one-byte characters or 8 double-bytes characters can be used as an addable comment.

\* Make sure of not exceeding the maximum bytes when specifying both one-byte characters and double-bytes characters.

### 13.2.5 Ethernet Protocol Settings

This section describes how to perform settings network connecting information for programming Web Controller with the programming software (LADDER EDITOR for Windows) on Web Controller. This information is also required for application of HMI software including display devices supported by Ethernet connection for HITACHI H/EH series PLC and SCADA.

By clicking [Ethernet Protocol] in the System Configuration index screen, the following screen will be displayed

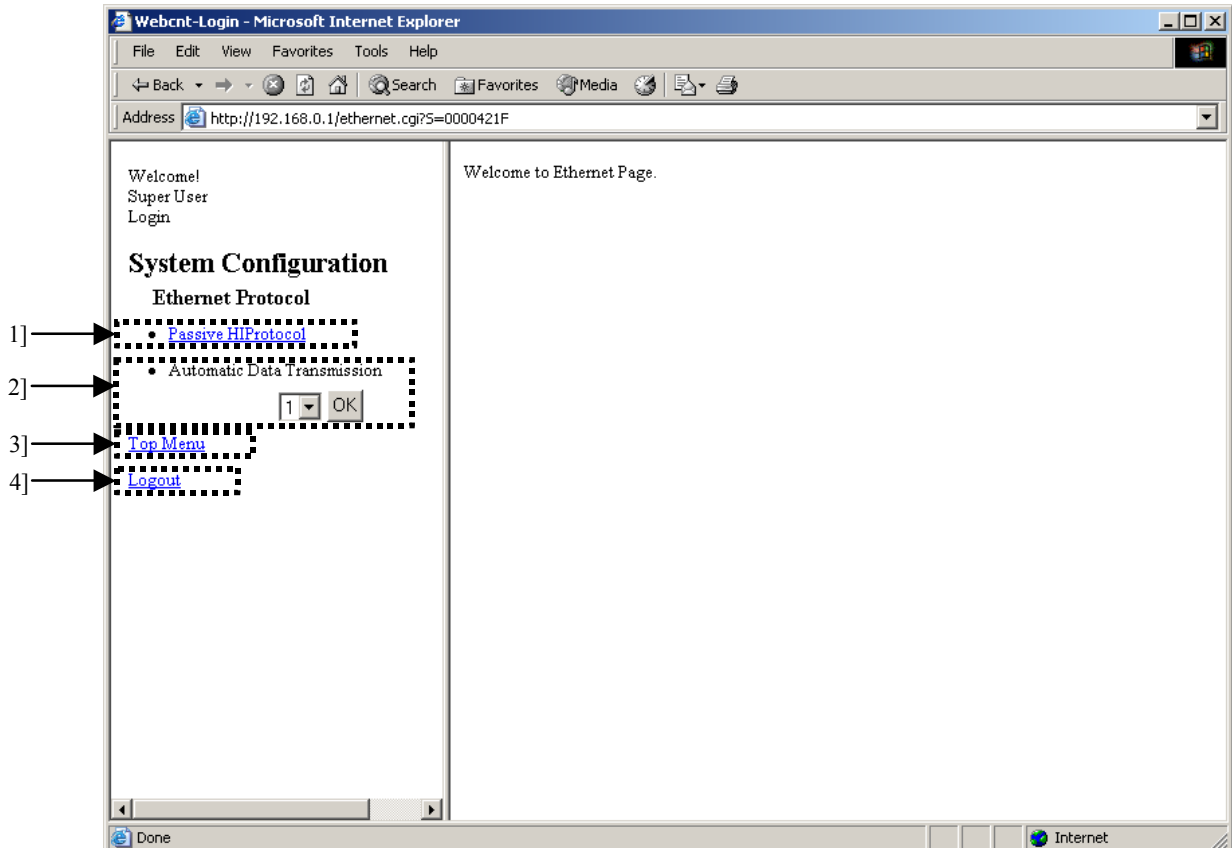

Figure 13.49 Ethernet Protocol menu screen

Table 13.45 Ethernet Protocol menu screen

No.	Name	Setting Options
1]	Passive HIProtocol	Setting of task code communication.
2]	Automatic Data Transmission	Setting of message communication.
3]	Top Menu	Return to the System Configuration index menu.
4]	Logout	Logout from the System Configuration.



(1) Task code communication

This section describes how to set the task code communication.

By clicking [Passive HIProtocol] in the Ethernet Protocol menu on the left, the following screen will be displayed.

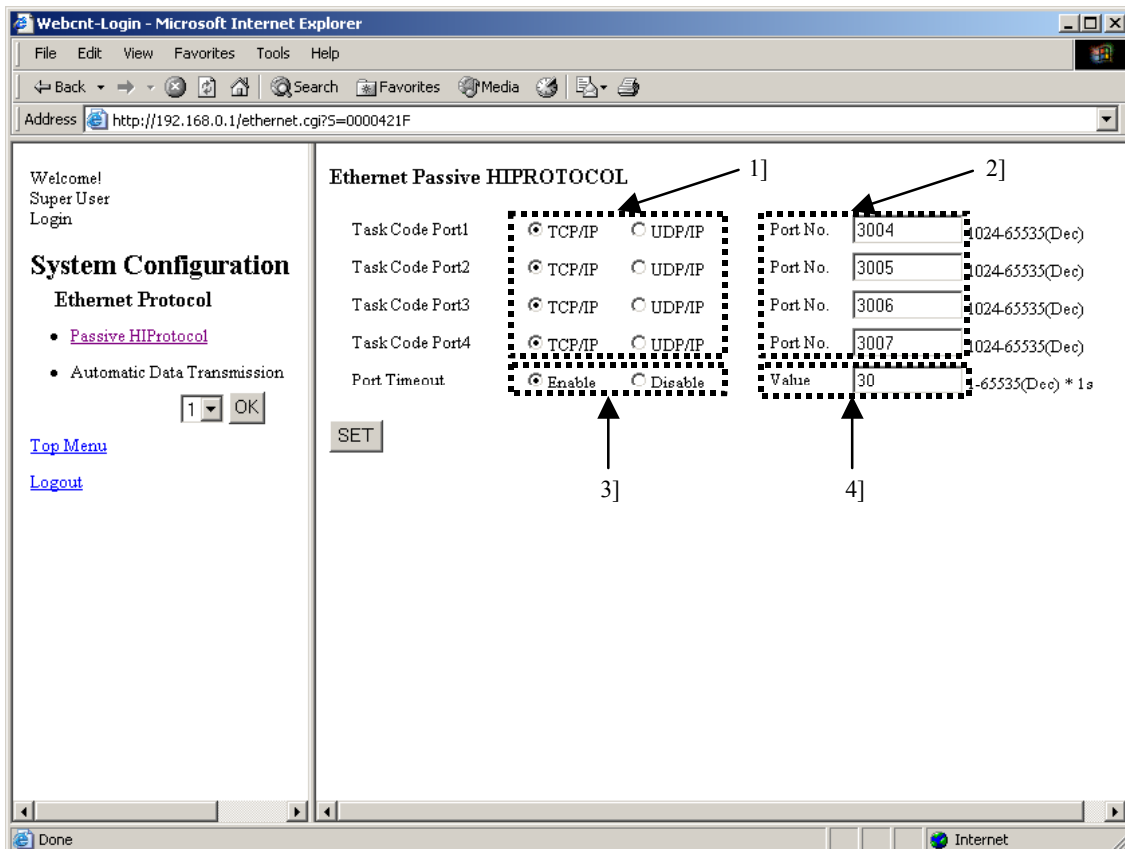

Figure 13.50 Ethernet Protocol - Passive HIProtocol setting screen

Table 13.46 Ethernet Protocol - Passive HIProtocol setting screen

No.	Name	Setting Options
1]	Task Code Port	Select a connection protocol for task code. Mark either TCP/IP or UDP/IP.
2]	Port No.	Set a logical port number of the connection for task code. Input a number within the range from 1024 to 65535.
3]	Port Timeout	Set whether or not to enable timeout of the connection for task code. This value affects to all connections for task code. When setting "Disable", 4] will be invalid. This timeout function monitors the duration of time when TCP packet is not received at the task code port. When a timeout is detected, the task code port sends out a packet including a connection cut-off request flag (FIN ACK).
4]	Value	Set a timeout duration of the connection for task code (in seconds). This value affects to all connection for task code. Input a number within the range from 1 to 65535.

(2) Message communication

This section describes how to set message communication on Web Controller.

By select connection number to set from the pull-down menu in the Ethernet Protocol menu to set message communication, and click the [Go] button, the following screen will be displayed.

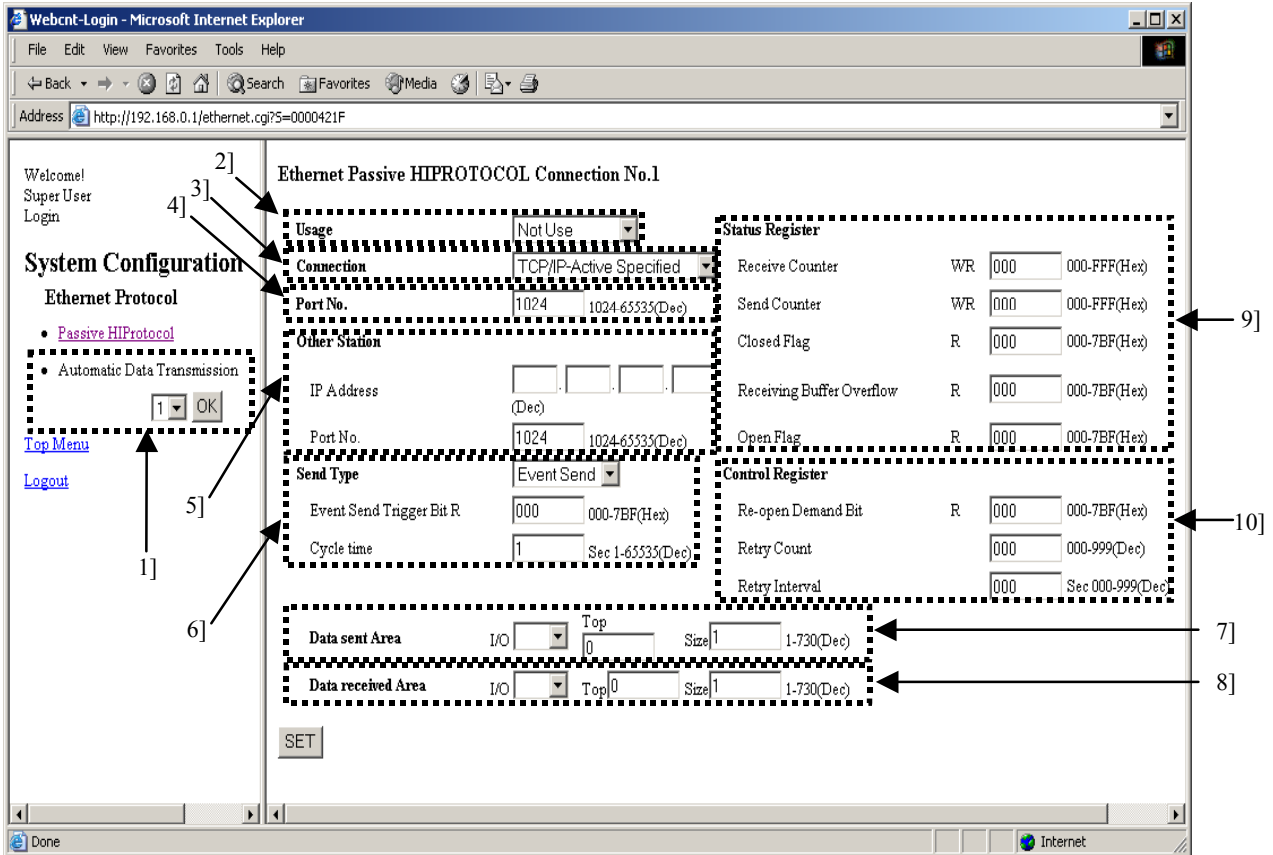

Figure 13.51 Ethernet Protocol – message communication setting screen

Table 13.47 Ethernet Protocol – message communication setting screen

No.	Name	Setting Options
1]	Automatic Data Transmission	Select a connection number.
2]	Usage	Select a communication usage. Not Use Send/Receive Send Receive
3]	Connection	Select a connecting type. TCP/IP-Active Specified TCP/IP-Passive Specified TCP/IP-Passive Optional UDP/IP Specified UDP/IP Optional
4]	Port No.	Input a port number of Web Controller.
5]	Other Station	Input the other station. IP Address Port No.
6]	Send Type	Select a sending type. Send Type Event Send Cyclic Send Event Send Trigger Bit R Cycle time
7]	Data sent Area	Select an area to send data. I/O: WR/WM/WX/WY Top Size: 1 to 730(Dec)
8]	Data received Area	Select an area to receive data. I/O: WR/WM/WY Top Size: 1 to 730(Dec)
9]	Status Register	Input a status register. Receiving Counter Transmitting Counter Closed Flag Receiving Buffer Overflow Open Flag
⑩	Control Register	Input a control register. a) Re-open Demand Bit b) Retry Count c) Retry Interval

## 13.2.6 Serial Port Settings

This section describes how to set communication using serial port on Web Controller.

By clicking [Serial Protocol] in the System Configuration index menu screen, the following screen will be displayed.

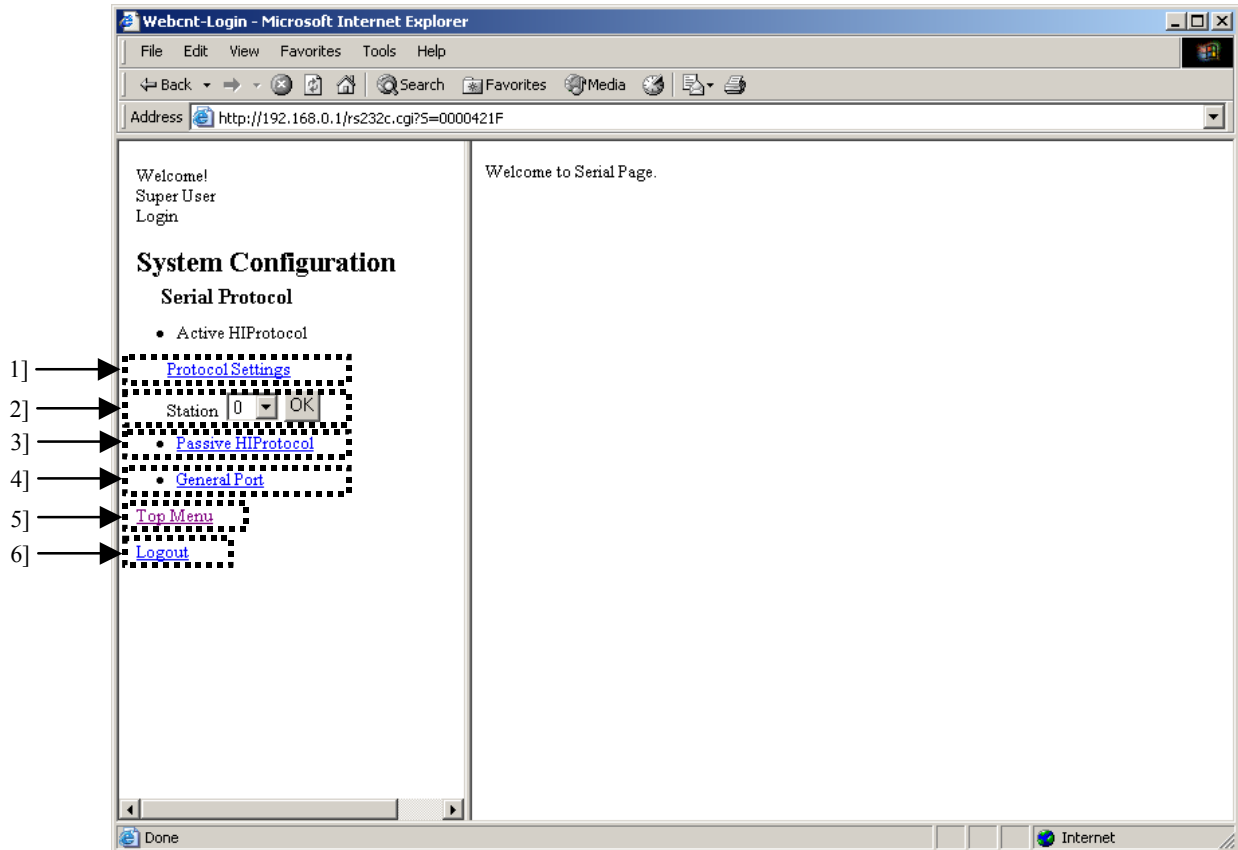

Figure 13.52 Serial Protocol menu screen

Table 13.48 Serial Protocol menu screen

No.	Name	Setting Options
1]	Active HIProtocol – Protocol Settings	Perform settings of Active HIProtocol.
2]	Active HIProtocol – Station	Perform settings of Active HIProtocol Station.
3]	Passive HIProtocol	Perform settings of Passive HIProtocol.
4]	General Port	Perform settings of general-purpose communication port.
5]	Top Menu	Return to the System Configuration menu.
6]	Logout	Logout from the System Configuration.

### ⚠ Caution!!

Using Active HIProtocol, Passive HIProtocol and General Port is not allowed at one in Web Controller. Note that if one of these settings is “Use”, other settings will be “Not Use” automatically.

(1) Active-HIPROTOCOL – Protocol Settings

This section describes how to perform Serial – Active HIProtocol Settings on Web Controller. By clicking [Protocol Settings] in the Serial Protocol menu, the following screen will be displayed.

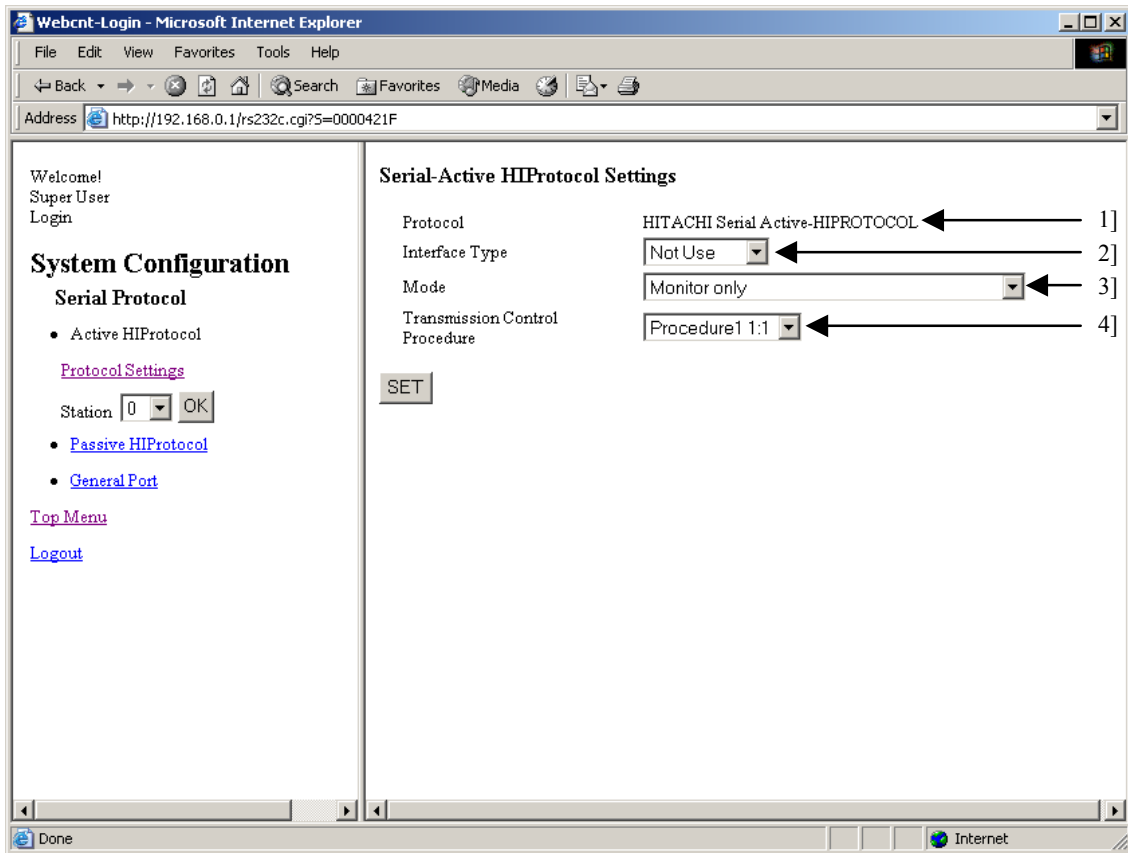

Figure 13.53 Serial Protocol - Active HIProtocol menu screen

Table 13.49 Serial Protocol - Active HIProtocol menu screen

No.	Name	Setting Options
1]	Protocol	Display a name of Protocol (Active HIProtocol).
2]	Interface Type	Select a communication type a) Not Use b) RS-232C c) RS-422 / 485
3]	Mode	Select a communication mode. a) Monitor only b) Monitor & I/O Set/Reset Trigger c) Datalink (Monitor & I/O Set/Reset alternately)
4]	Transmission Control Procedure	Select a transmission control procedure. a) Procedure1 1:1 b) Procedure1 1:N c) Procedure2 1:1 d) Procedure2 1:N

(2) Active-HIPROTOCOL – Station

This section describes how to perform settings of Active HIProtocol Station number on Web Controller.

By selecting station number to set from the list box and clicking the [OK] button in the Serial Protocol menu on the left, the following screen will be displayed.

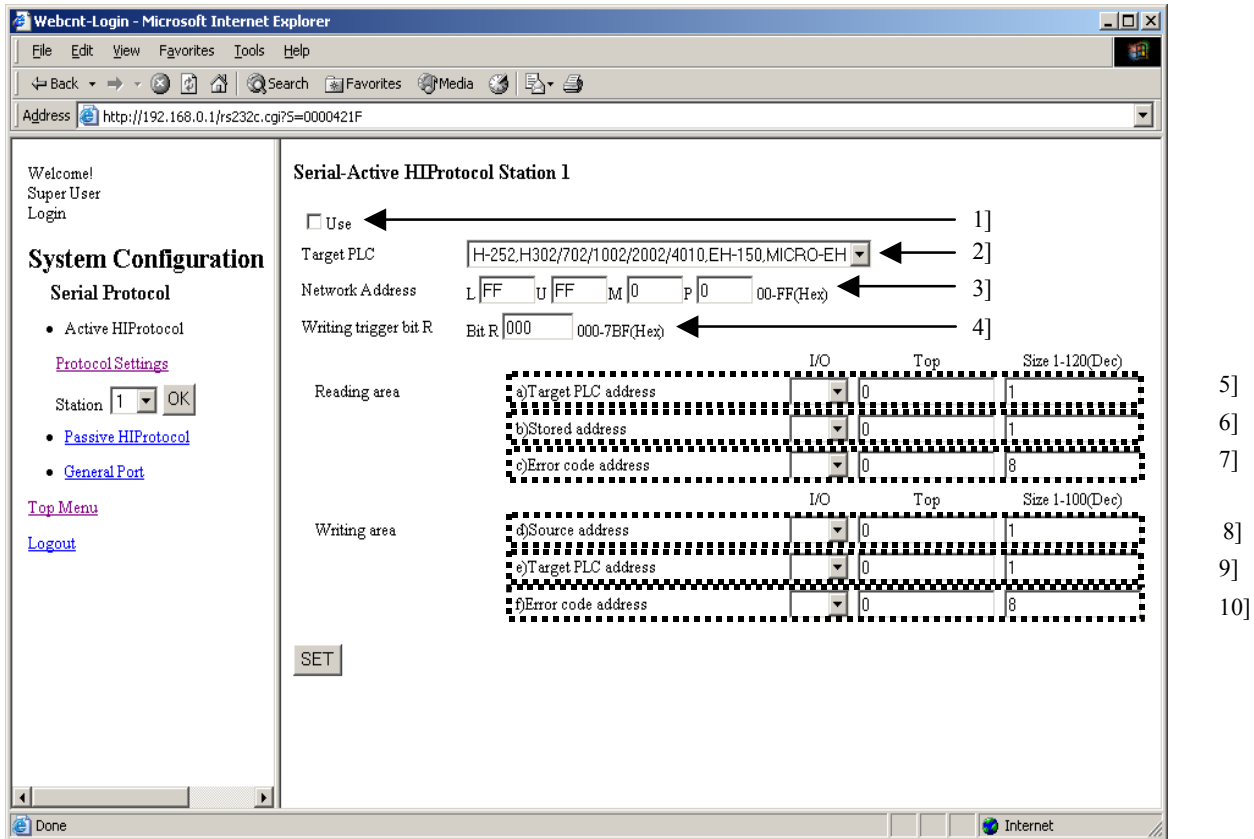
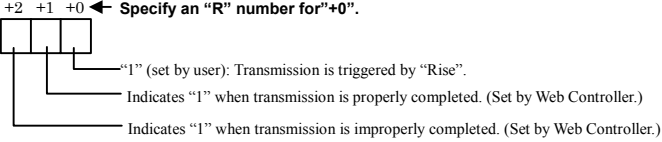

Figure 13.54 Serial Protocol - Active HIProtocol menu screen

Table 13.50 Serial Protocol - Active HIProtocol menu screen

No.	Name	Setting Options
1]	Use	Check this box when using this station number.
2]	Target PLC	Select a type of connected PLC. a) H-20/40/64, H-200/250, H-300/700/2000 b) H-252, H302/702/1002/2002/4010, EH-150, MICRO-EH
3]	Network Address	Specify a network address defined by the task code which is the protocol of HITCHIH/EH series PLC. Refer to Appendix 2 in Controller Manual for details.
4]	Writing trigger bit	If the communication mode is set to "Monitor & I/O Set/Reset Trigger", select a bit internal output "R" to be used as the trigger. 
5]	Target PLC address	Specify a monitoring data area on the connected PLC to read out. a) I/O type: Select from WR/WM/WL/WX/WY b) Top I/O number: c) Size: Maximum 120 words (hexadecimal)
6]	Stored address	Specify an area on Web Controller to store data received from the connected PLC. a) I/O type: Select from WR/WM/WY b) Top I/O number: c) Size: (The number of areas specified in 4] is ensured.)
7]	Error code address	Specify an area to store error codes when data from the connected PLC fails to be received. a) I/O type: Select from WR/WM b) Top I/O number: c) Size: (Cannot set because of fixing to 8 words.)
8]	Source address	Specify a sending area on Web Controller. a) I/O type: Select from WR/WM/WX/WY b) Top I/O number: c) Size: Maximum 100 words (hexadecimal)
9]	Target PLC address	Specify a forced set area on the connected PLC. a) I/O type: Select from WR/WM/WL/WY b) Top I/O number: c) Size: (The number of area specified in 7] is ensured.)
10]	Error code address	a) I/O type: Select from WR/WM b) Top I/O number: c) Size: (Cannot set it because of fixing to 8 words.)

## (3) Passive-HIPROTOCOL

This section describes how to perform settings of Passive HIProtocol on Web Controller.

By clicking [Passive HIProtocol] in the Serial Protocol menu on the left, the following screen will be displayed.

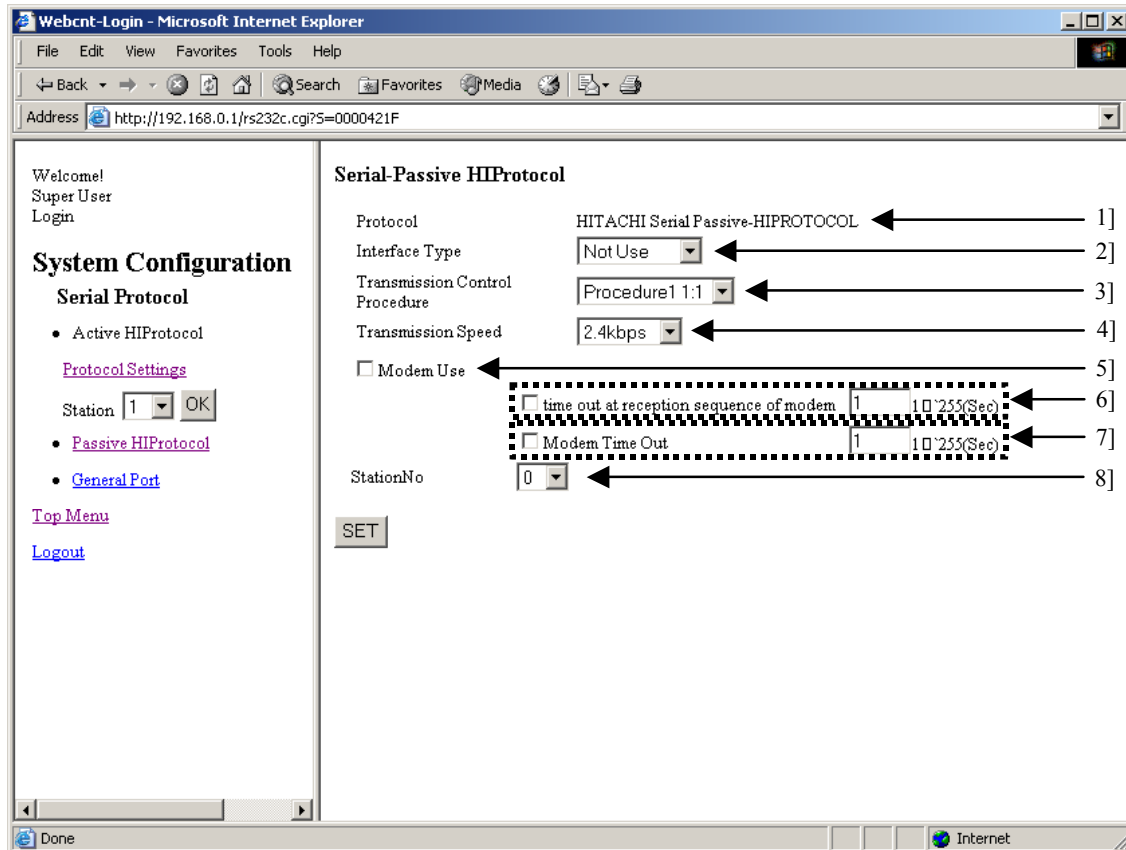

Figure 13.55 Serial Protocol - Passive HIProtocol menu screen

Table 13.51 Serial Protocol - Passive HIProtocol menu screen

No.	Name	Setting Options
1]	Protocol	Display name of protocol. (Passive HIProtocol) This text box is unchangeable.
2]	Interface Type	Select a communication type. a) Not Use b) RS-232C c) RS-422 / 485
3]	Transmission Control Procedure	Select a transmission procedure. a) Procedure1 1:1 b) Procedure1 1:N c) Procedure2 1:1 d) Procedure2 1:N
4]	Transmission Speed	Select a transmission speed. a) 2.4kbps b) 4.8kbps c) 9.6kbps d) 19.2kbps e) 38.4kbps f) 57.6kbps
5]	Modem Use	Set whether or not to use a modem. Check this box when using.
6]	Time out at reception sequence of modem	Set a time out at reception sequence of modem. Check the check box and input duration of time within the range from 1 to 255 when using the time out at reception sequence of modem.
7]	Modem Time Out	Set a modem time out. Check the check box and input duration of time within the range from 1 to 255 when using the modem time out.
8]	Station No.	Select a station number.



(4) General Port

This section describes how to perform settings of general purpose communication on Web Controller. By clicking [General Port] in the Serial Protocol menu on the left, the following screen will be displayed.

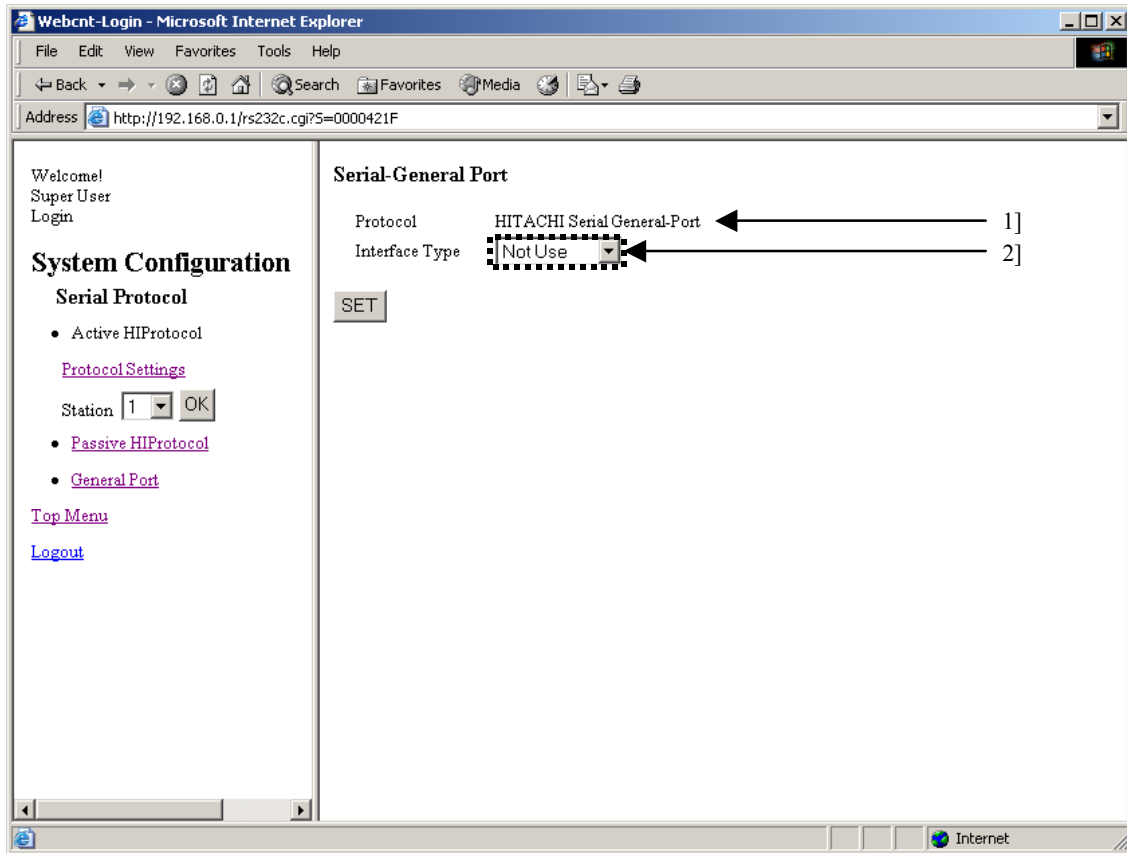

Figure 13.56 Serial Protocol - General Port menu screen

Table 13.52 Serial Protocol - General Port menu screen

No.	Name	Setting Options
1]	Protocol	Display name of protocol (General Port). This text box is unchangeable.
2]	Interface Type	Select whether or not to use a general purpose communication. a) Not Use b) RS-232C c) RS-422 / 485

## 13.2.7 ID/Password Settings

This section describes how to perform settings of ID/Password on Web Controller.

By Clicking [ID/Password] in the System Configuration index menu screen, the following screen will be displayed.

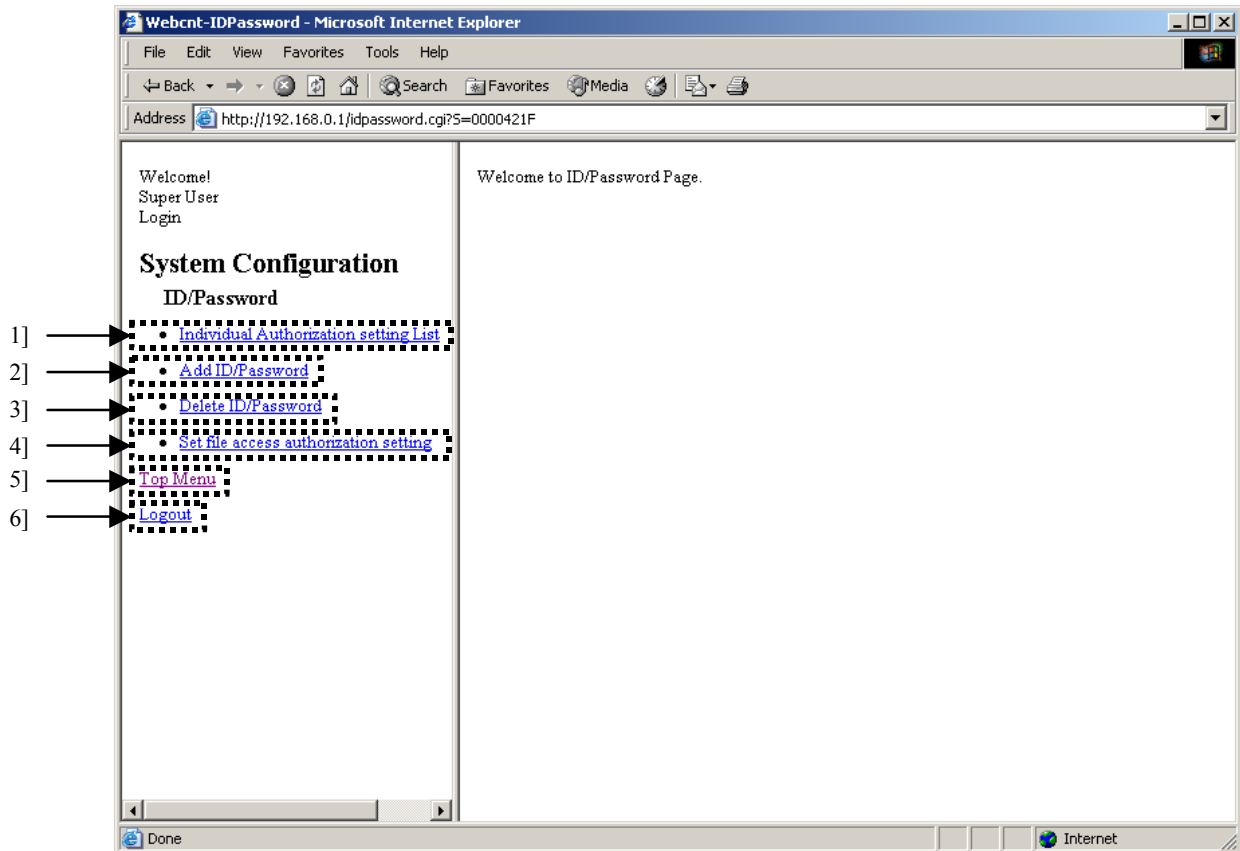

Figure 13.57 ID/Password menu screen

Table 13.53 ID/Password menu screen

No.	Name	Setting Options
1]	Individual Authorization setting List	Displays an access authorization of file for each User ID.
2]	Add ID/Password	Registers User ID/Password.
3]	Delete ID/Password	Deletes User ID/Password.
4]	Set file access authorization setting	Sets an access authorization of file.
5]	Top Menu	Returns to the System Configuration index menu screen.
6]	Logout	Logouts from the System Configuration.

(1) Individual Authorization setting List

Displays an access authorization of the file for each registered User ID on Web Controller.

By clicking [Individual Authorization setting List] in the ID/Password menu on the left, the following screen will be displayed.

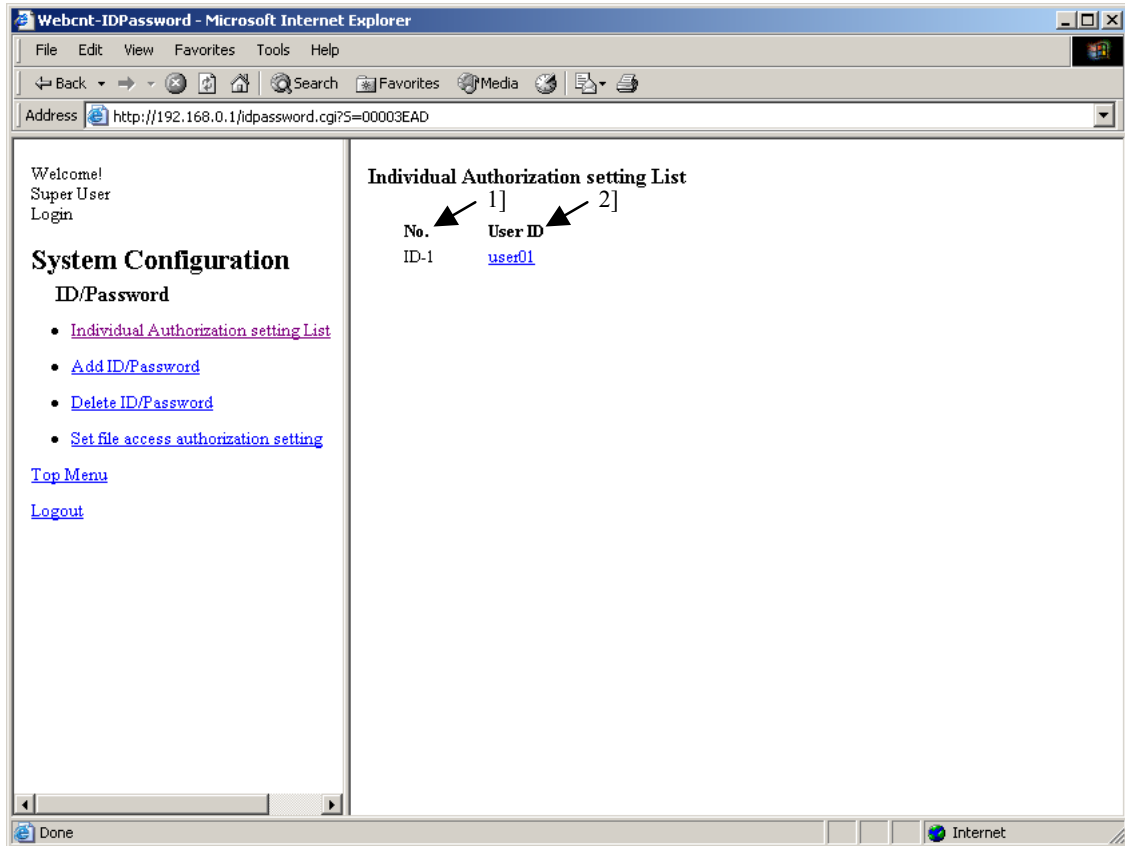

Figure 13.58 ID/Password - Individual Authorization setting List screen

Table 13.54 ID/Password - Individual Authorization setting List screen

No.	Name	Setting Options
1]	No.	Displays User ID number.
2]	User ID	Displays name of User ID. Click this link to view a list of the access authorization for each User ID.

By clicking the user name to view the access authorization of the file of the user on this screen, the following screen will be displayed.

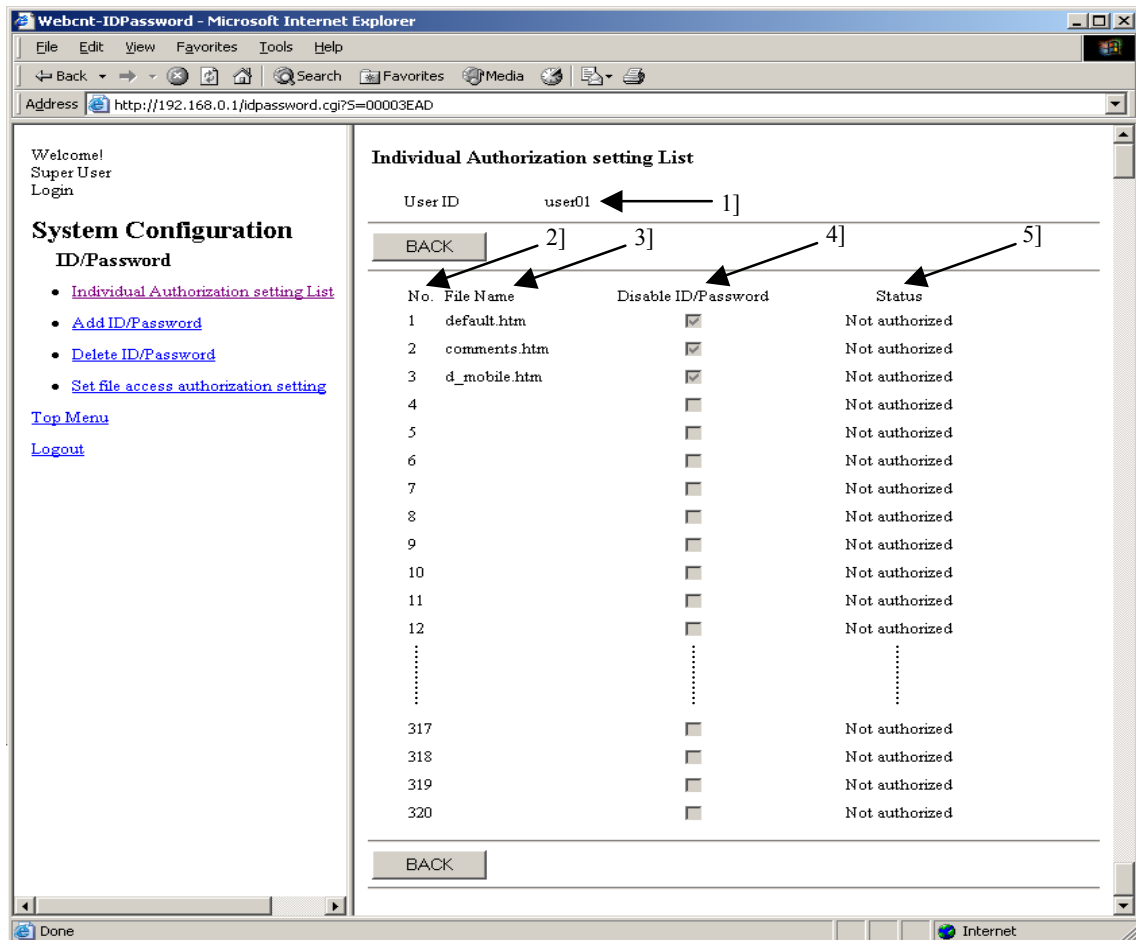

Figure 13. 59 ID/Password - Individual Authorization setting List screen

Table 13.55 ID/Password - Individual Authorization setting List screen

No.	Name	Setting Options
1]	User ID	Displays the User ID whose list of the access authentication is being displayed.
2]	No.	Displays the File number.
3]	File Name	Displays the File name. No file name is displayed when Web Controller does not store tiles under the File No.
4]	Disable ID/Password	Indicates whether or not to require the ID/Password authentication when accessing the file. ID/Password authentication is not required when checked this.
5]	Status	Indicates whether or not the user is authorized to access the file. Even if the ID/Password is authenticated, the user cannot access the file without the access authorization. Authorized : Accessing the file is permitted. Not Authorized : Accessing the file is not permitted.

### ⚠ Caution!!

Note that the file can be accessed without ID/Password if the “Disable ID/Password” check box is marked and the “Status” is set to “Not authorized”. This happens because Web Controller performs processing based on the Disable ID/Password status first, and the setting of the Status is effective on the processing only when unmarking the check box. Therefore, **be sure to unmark the Disable ID/Password check box to set an access control to a file.**

(2) Add ID/Password

Registers User ID and Password. 16 User IDs and Passwords can be registered. Both ID and Password can be specified using from 1 to characters which are one-byte character's capital letters, small letters and numeral. By clicking [Add ID/Password] in the ID/Password menu on the left, the following screen will be displayed.

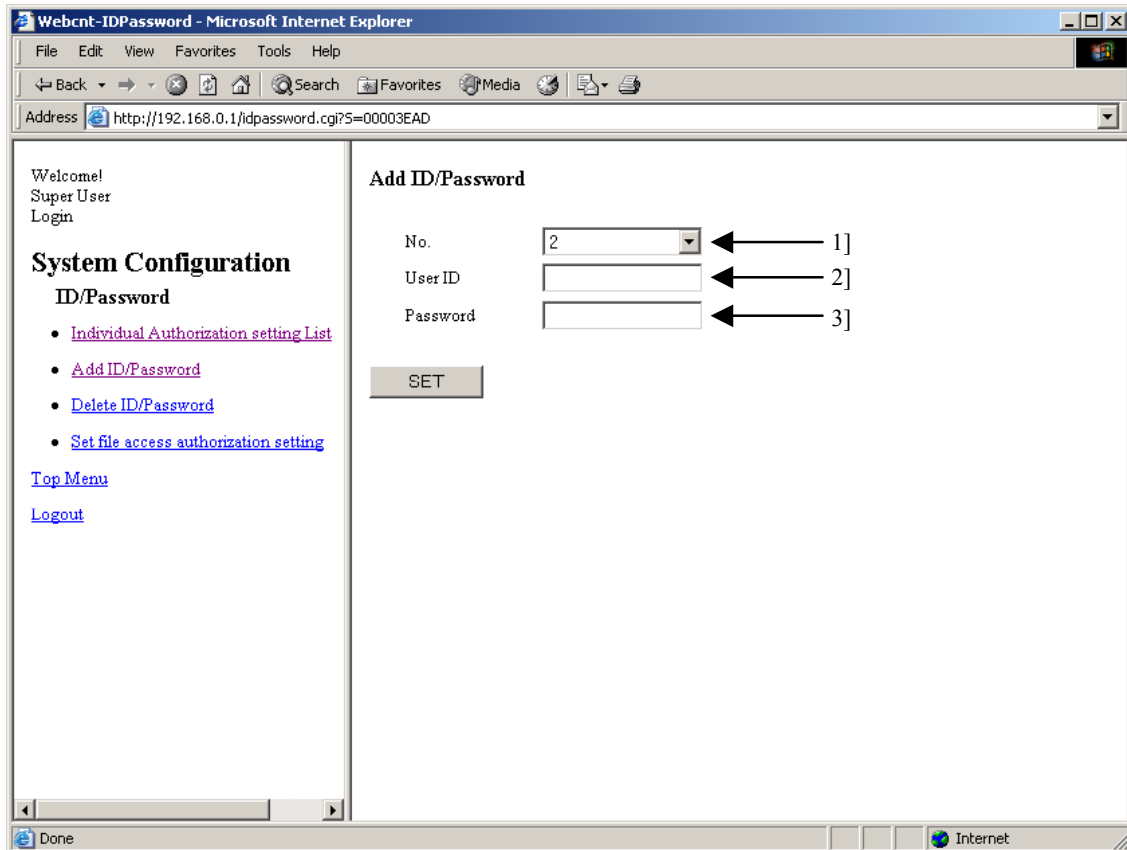

Figure 13.60 ID/Password - Add ID/Password screen

Table 13.56 D/Password - Add ID/Password screen

No.	Name	Setting Options
1]	No.	Specifies User ID number. The number from 1 to 16 can be specified. A registered number cannot be specifies.
2]	User ID	Sets User ID. It is possible to set using from 1 to 16 characters which are one-byte character's capital letters, small letter, and numeral.
3]	Password	Sets User ID's Password. It is possible to set using from 1 to 16 characters which are one-byte character's capital letters, small letters and numeral.

## (3) Delete ID/Password

Deletes the registered User ID and Password.

By clicking [Delete ID/Password] in the ID/Password menu on the left, the following screen will be displayed.

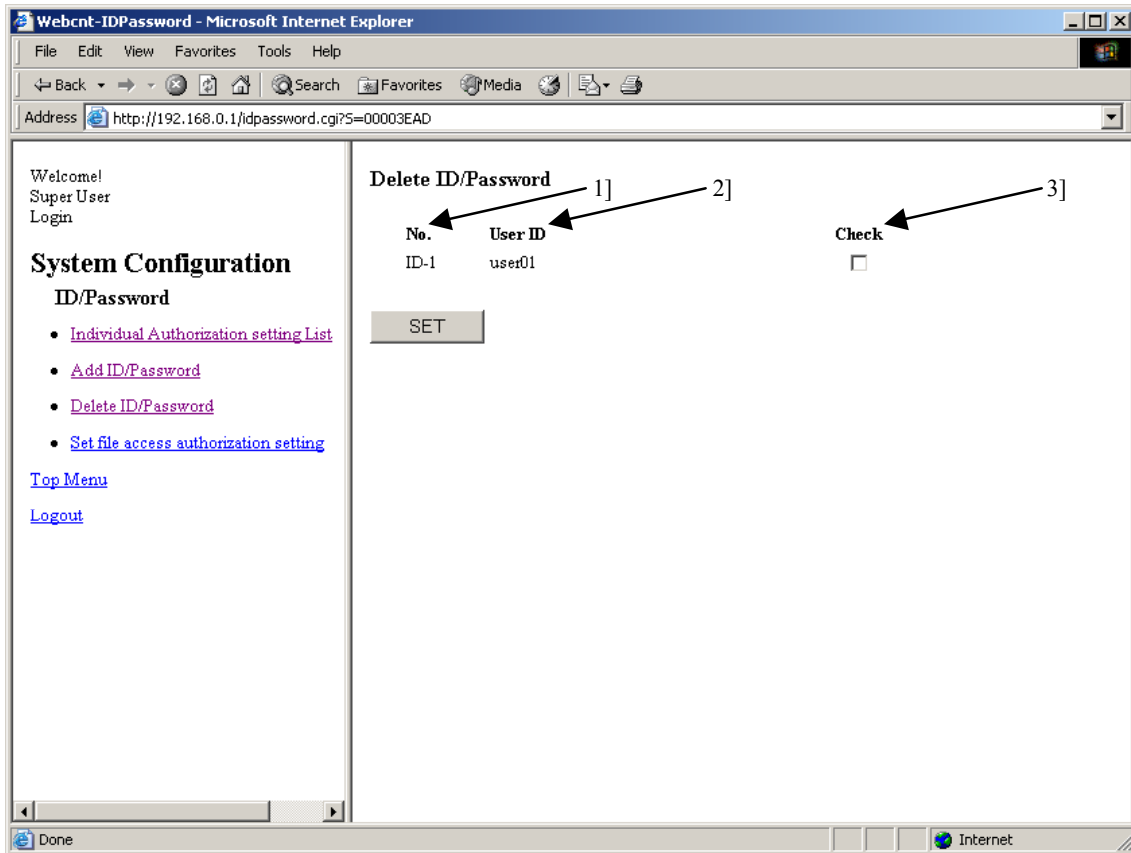

Figure 13.61 ID/Password - Delete ID/Password screen

Table 13.57 ID/Password - Delete ID/Password screen

No.	Name	Setting Options
1]	No.	Displays User ID number.
2]	User ID	Displays a name of User ID. Clicks this link to view a list of the access authorization for each User ID.
3]	Check	Mark a check box of ID/Password which you want to delete.

(4) Set file access authorization setting

Sets a file access authorization. File access authorization should be set for each file.

By clicking [Set file access authorization setting] in the ID/Password menu on the left, the following screen will be displayed.

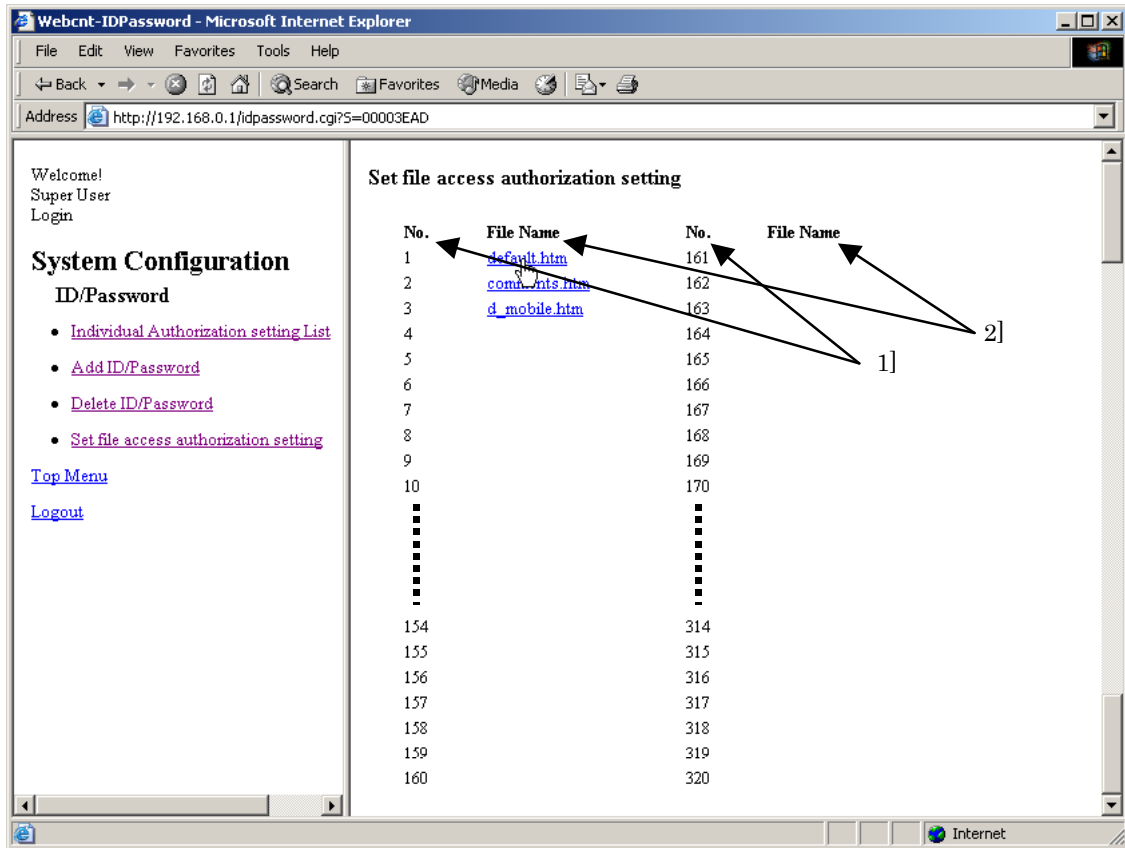

Figure 13.62 ID/Password - Set file access authorization setting screen

Table 13.58 ID/Password - Set file access authorization setting screen

No.	Name	Setting Options
1]	No.	Displays a file number.
2]	File Name	Displays a file name. Clicks this link to access to an access authorization setting screen for each file.

By clicking the file name to set the file access authorization on this screen, the following screen will be displayed.

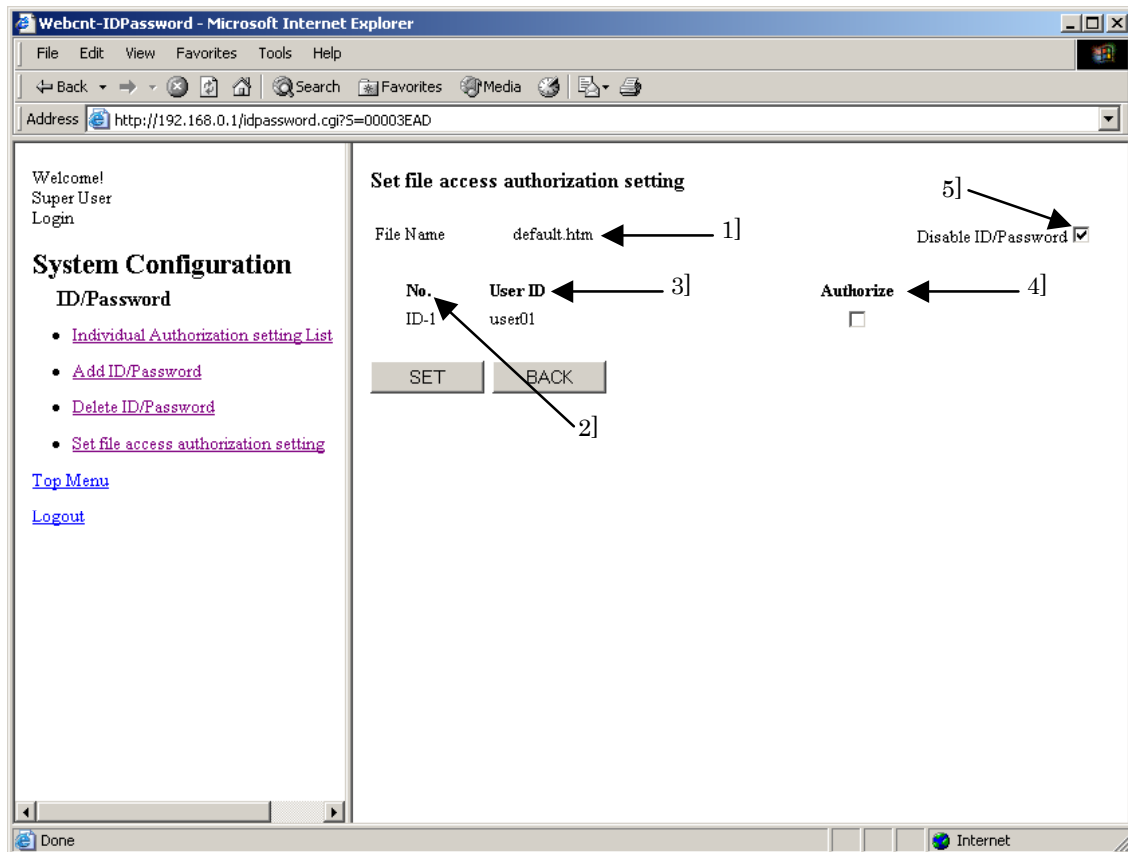

Figure 13.63 ID/Password - Set file access authorization setting screen

Table 13.59 ID/Password - Set file access authorization setting screen

No.	Name	Setting Options
1]	File Name	Displays a name of a file being set.
2]	No.	Displays User UD number.
3]	User ID	Displays a name of User ID.
4]	Authorize	Sets user's access authorization on this file. When "Disable ID/Password" for this file is unmarked, this file can be accessed after the user's ID/Password is authenticated if this check box is marked. If this check box is unmarked, however, this file cannot be accessed even if the ID/Password is authenticated.
5]	Disable ID/Password	If this check box is marked, this file can be accessed without ID/Password. <b>Be sure to unmark this check box to set an access control to a file.</b>

The following table describes available access authorization setting options.

Table 13.60 ID/Password – a list of Set file access authorization settings

	Disalbe ID/Password	Authorize	Setting Options 設定内容
1	-	-	Not accessible even with User ID and Password.
2	-	✓	Not accessible without User ID and Password.
3	✓ □	-	Accessible without User ID and Password.
4	✓	✓	

✓ : with check

-: without check

### ⚠ Caution!!

Setting of access authorization is not done for each file but is done for each file number. Therefore, the access authorization will be remained even if the file is deleted. The remained access authorization information will be kept for new registered file with same file number.



### 13.2.8 Changing password for mail settings

This section describes how to change a password for mail settings.

By clicking [Change password for mail settings] in the System Configuration index menu screen, the following screen will be displayed.

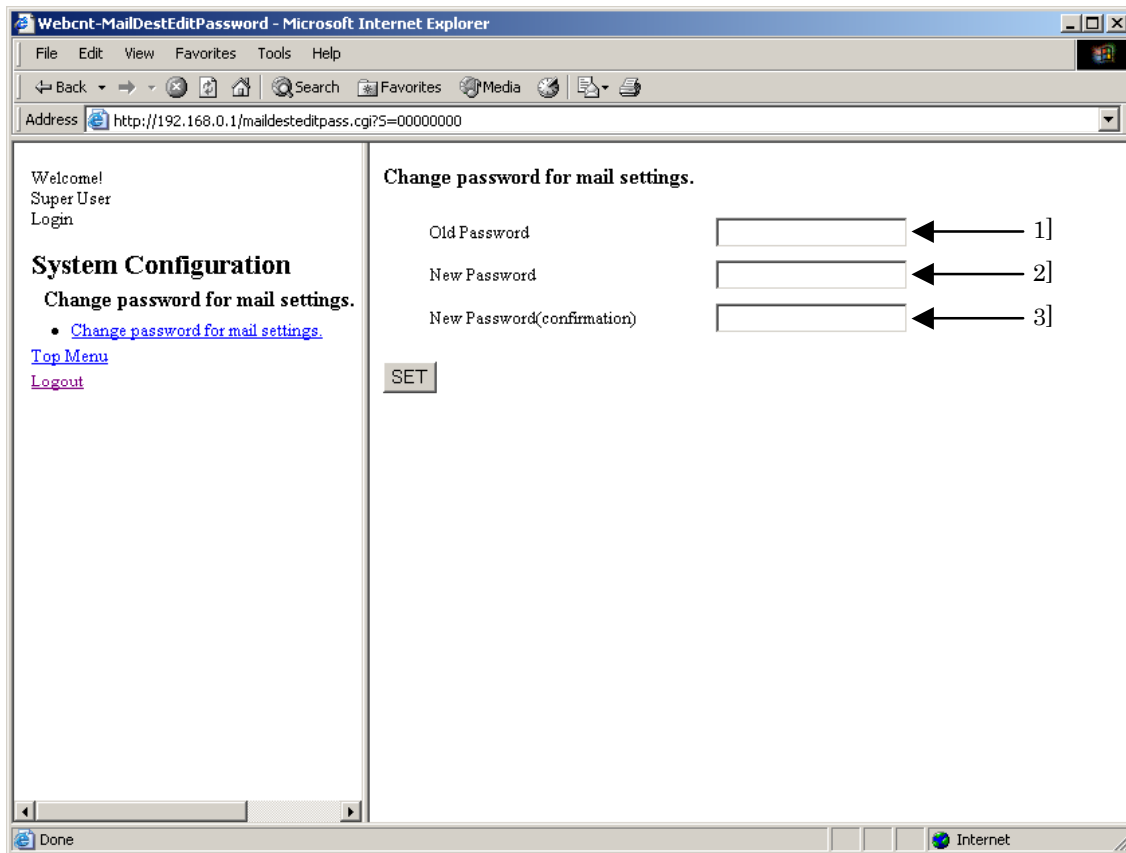

Figure 13.64 Password change screen on the mail settings

Table 13.62 Password change screen on the mail settings

No.	Name	Setting Options
1]	Old Password	Input a password currently used for mail settings page.
2]	New Password	Input a new password for mail settings page. Characters from 1 to 16 which are one-byte character's capital letters, small letters and numeral can be used for password.
3]	New Password (confirmation)	Input the new password for mail settings page again for confirmation.

#### Caution!!

Initial password is “**1111**” for the mail settings. Keeping the password in initial setting may become a security hole. Therefore, be sure to change the initial password for the mail settings into any others

### 13.2.9 Changing password for I/O Set

This section describes how to change a password for I/O ser.

By clicking [Change password for I/O writing] in the System Configuration index menu screen, the following screen will be displayed.

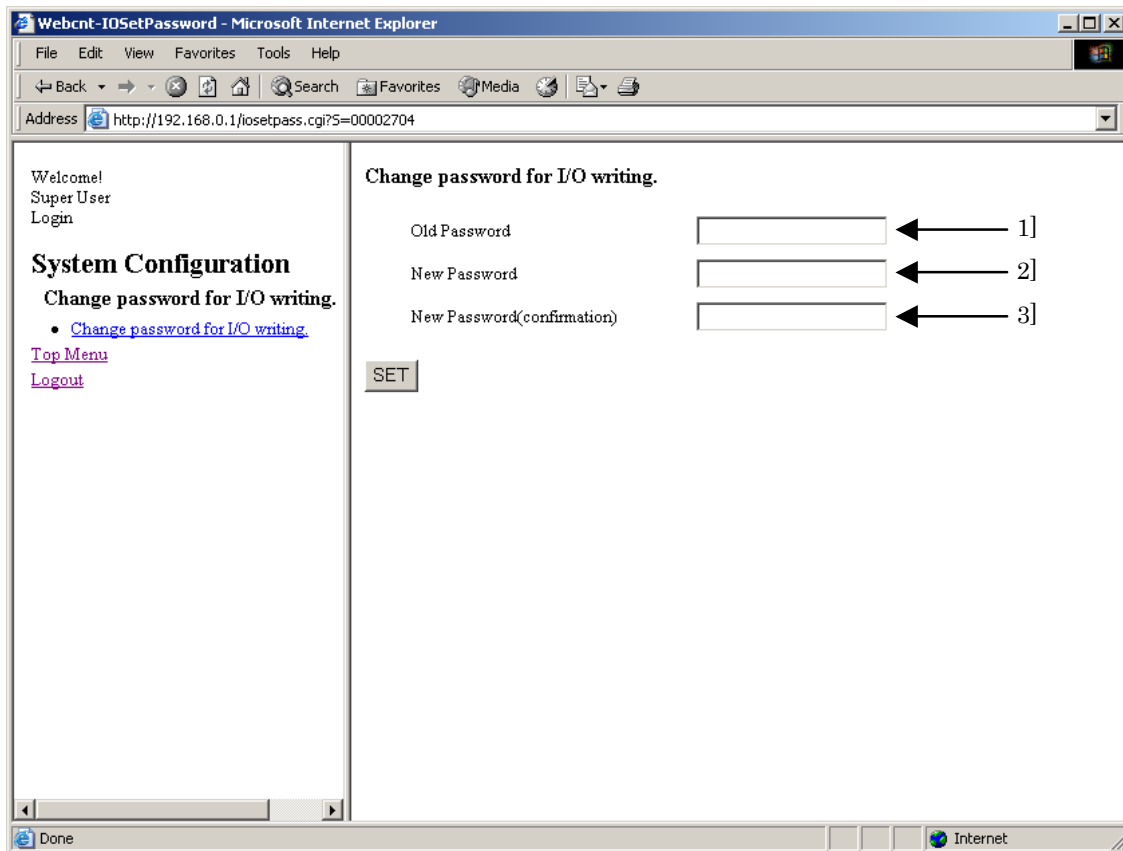

Figure 13.65 Password change screen for I/O set

Table 13.62 Password change screen for I/O set

No.	Name	Setting Options
1]	Old Password	Input a password currently used for I/O set.
2]	New Password	Input a new password for I/O set. Characters from 1 to 16 which are one-byte character's capital letters, small letters and numeral can be used for a password.
3]	New Password (confirmation)	Input the new password for I/O set again for confirmation.

#### Caution!!

Initial password is “**1111**” for I/O set. Keeping the password in initial setting may become a security hole. Therefore, be sure to change the initial password for I/O set into any others.

### 13.2.10 Analog Input/Output Settings

This section describes how to perform Analog Input/Output settings on Web Controller. This function is supporting only 23 points type.

By clicking [Analog Interface] in the System Configuration index menu screen, the following screen will be displayed.

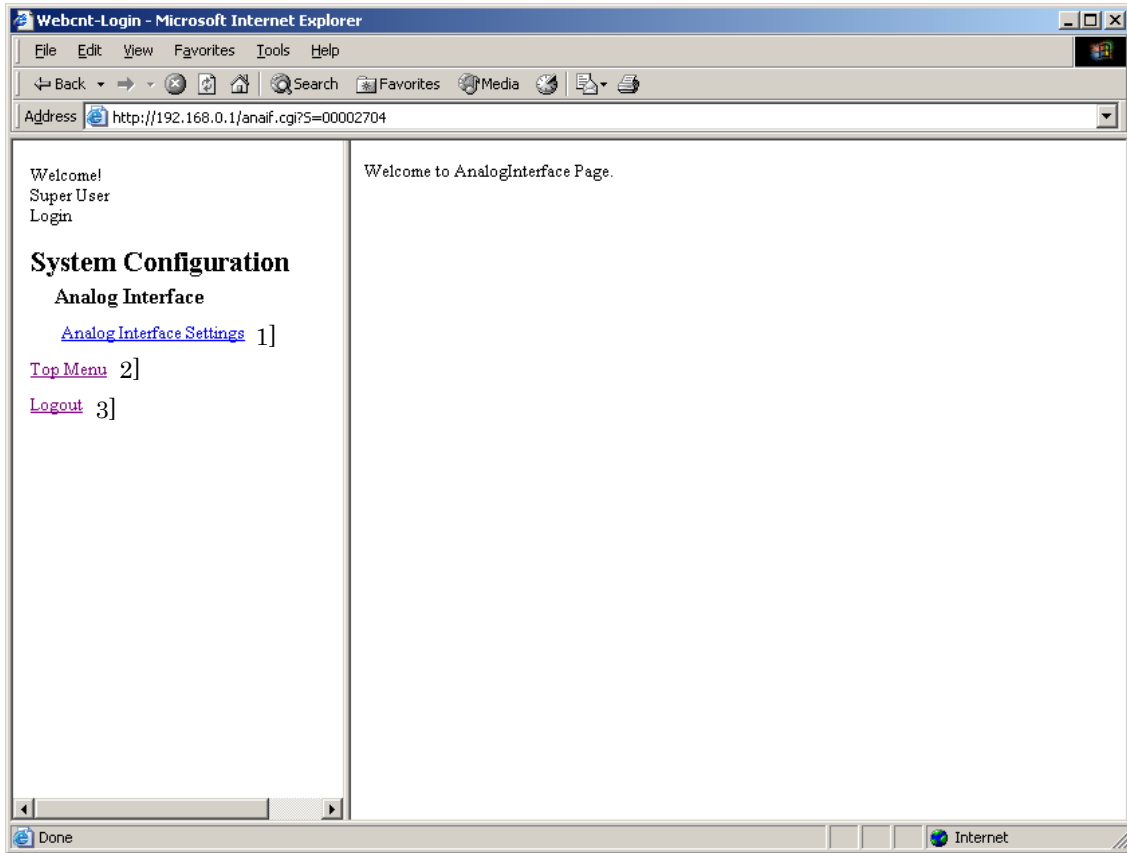

Figure 13.66 Analog Interface menu screen

Table 13.63 Analog Interface menu screen

No.	Name	Setting Options
1]	Analog Interface Settings	Displays a setting screen of Analog Interface on the main screen.
2]	Top Menu	Returns to the System Configuration index menu screen.
3]	Logout	Logout from the System Configuration.

By clicking [Analog Interface Settings] in the Analog Interface menu screen, the following screen will be displayed.

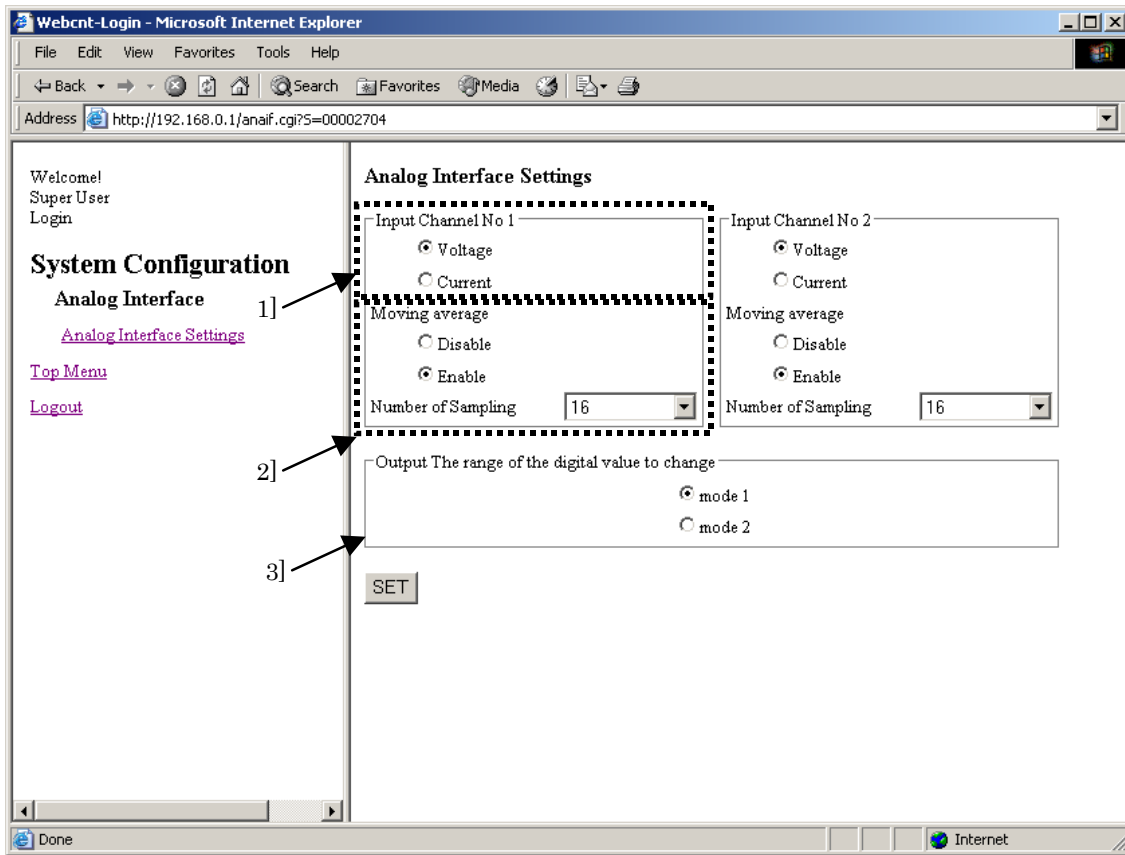

Figure 13.67 Analog Interface Settings screen

Table 13.64 Analog Interface Settings screen

No.	Name	Setting Options
1]	Input type	Select an analog input type. a) Voltage b) Current
2]	Moving average	Sets whether or not to use Moving average. Disable Enable Specifies the number of samples to use for Moving average within the range from 2 to 16.
3]	Output Mode	Sets Analog output mode. a) mode 1 b) mode 2

#### - Output Mode

It is possible to select the following two operation modes as a processing when a digital value which is 4095 (H0FFF) or more is set to WY40.

mode1: A value which from 4095 (H0FFF) to 65535(HFFFF) is used as 10.2375[V]/20.475[mA].

(Even if the value which is 4096 or more is set to WY40, it can prevent Output voltage/Current value from diving.)

mode2: Only lower 12 bits data are effective and the value is output even if D/A conversion is performed. This is a same conversion method as MICRO-EH series. Use this when compatibility is must be considered.

(If 4096 (H1000) is set to WY40, Output value/Current value will be "0" because an effective data will be "0".)

### 13.2.11 SNMP

This section describes how to perform SNMP settings on Web Controller. This function is supporting only 23 points type.  
 By clicking [Analog Interface] in the System Configuration index menu screen, the following screen will be displayed.

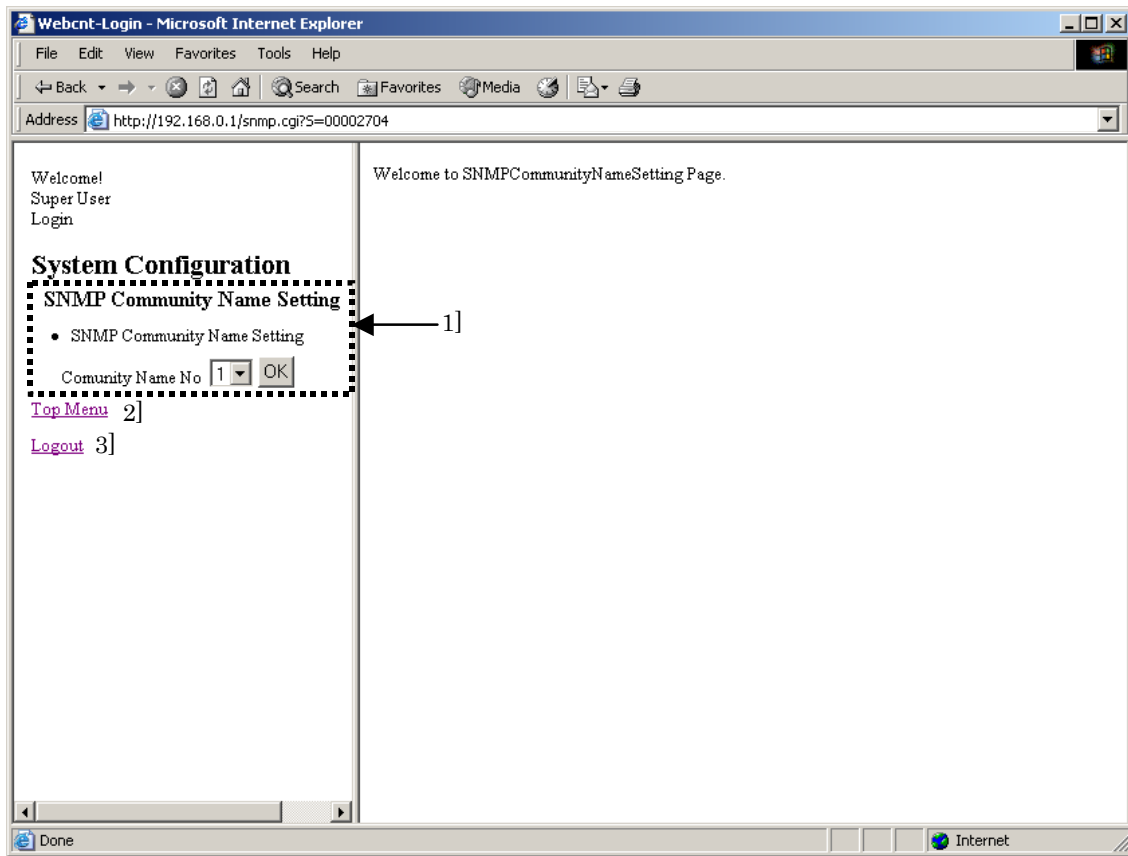

Figure 13.68 SNMP screen

Table 13.65SNMP screen

No.	Name	Setting Options
1]	Community Name No.	By selecting from No.1 to No.5 in the pull-down menu and clicking the [OK] button, displays the Community Name Settings screen of each Community Name number.
2]	Top Menu	Returns to the System Configuration index menu screen.
3]	Logout	Logout from the System Configuration

Selects the Community Name number to set from the pull-down menu and click the [OK] button in the SNMP menu on the left. Then the following screen will be displayed (this is an example screen for Community Name No.1). Community Name number from 1 to 5 can be used.

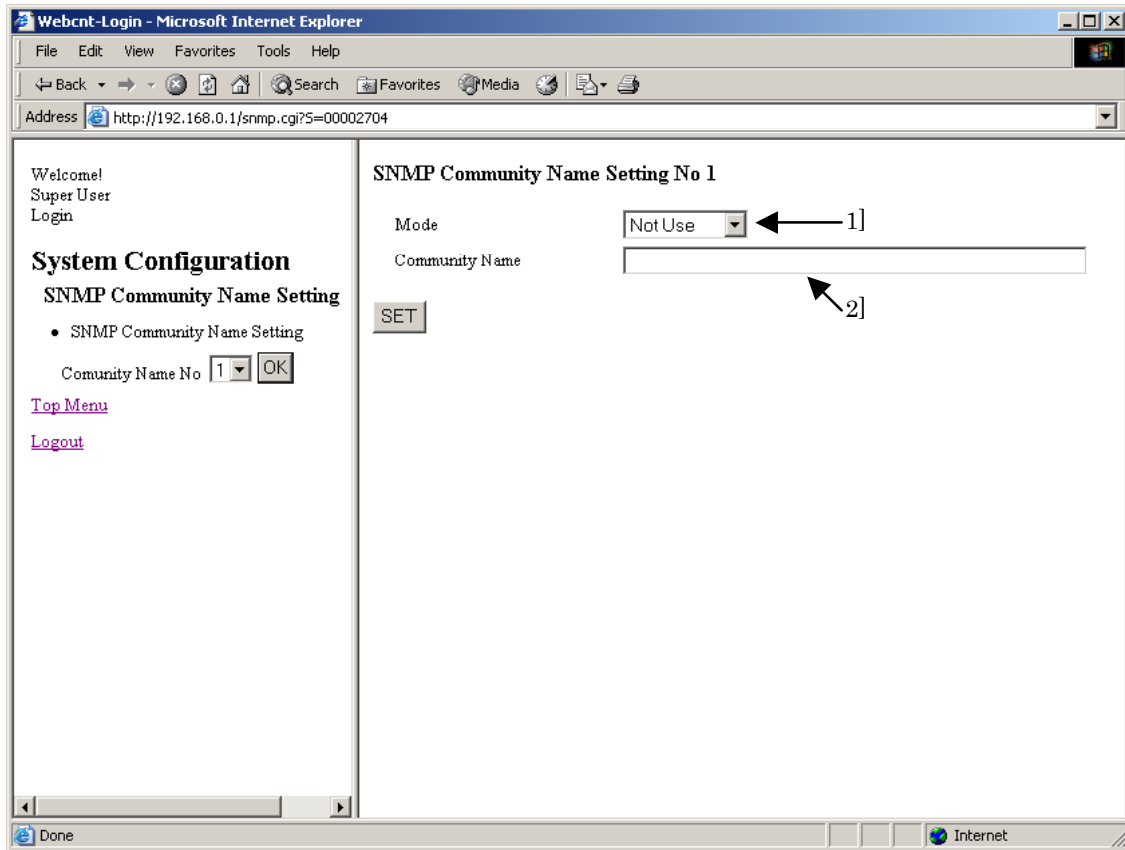

Figure 13.69 SNMP – Community Name Setting screen

Table 13.66 SNMP – Community Name Setting screen

No.	Name	Setting Options
1]	Mode	Sets a SNMP mode. a) Not Use b) Read Only c) Read Write
2]	Community Name	Sets a Community Name.

### 13.2.12 Upload/Download configuration file

Configuration information can be downloaded to PC as configuration file. And also, the configuration file can be uploaded in to Web Controller and performs the setting on Web Controller. This function is supporting only 23 points type.

By clicking [Analog Interface] in the System Configuration index menu screen, the following screen will be displayed.

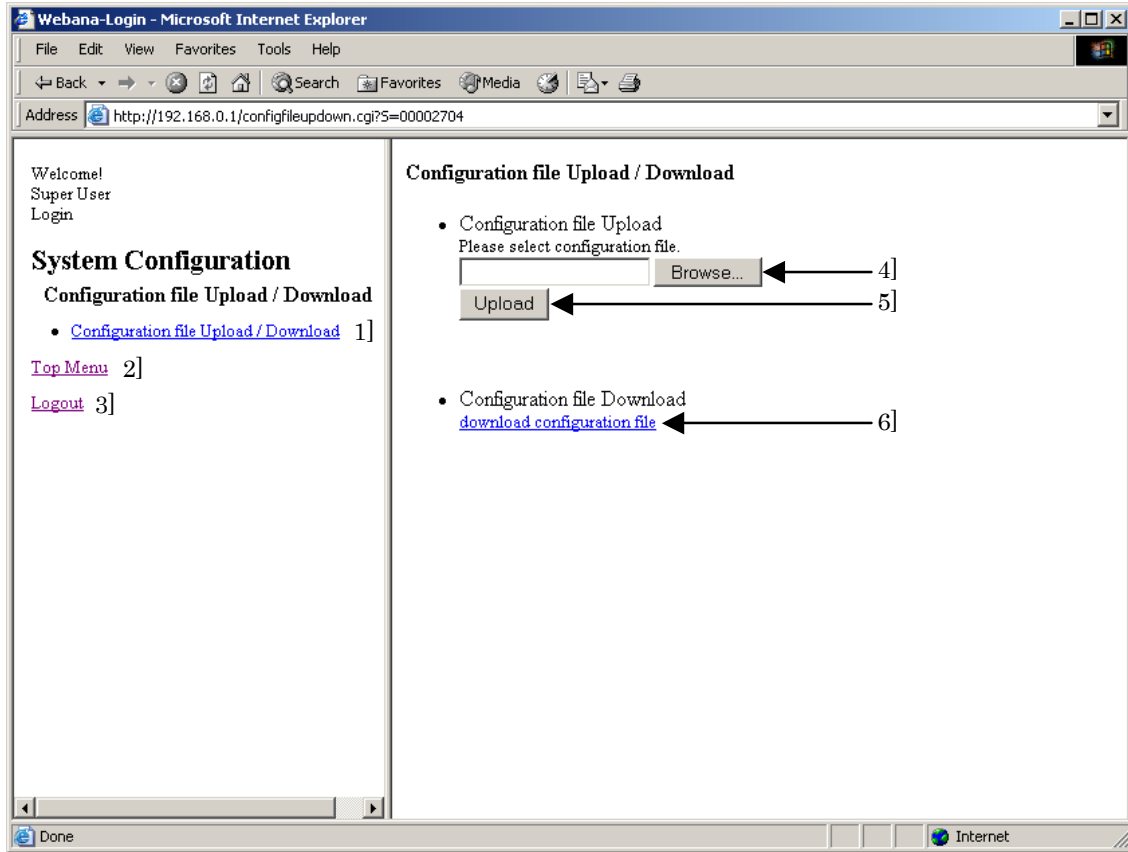

Figure 13.70 Configuration File Upload/Download screen

Table 13.67 Configuration File Upload/Download screen

No.	Name	Setting Options
1]	Configuration file Upload / Download	Re-displays Configuration file Upload/Download screen in the main screen on the right.
2]	Top Menu	Returns to the System Configuration index menu screen
3]	Logout	Logouts from the System Configuration.
4]	File specification	Specifies a file to upload into Web Controller in this text box.
5]	Upload	By clicking the [Upload] button, the upload into Web Controller starts.
6]	Download	Downloads configuration file from Web Controller to PC.

## 13.3 Remarks

### (1) Access control

Simultaneous access to the System Configuration page from multiple PCs is not permitted. Access to the System Configuration page is not permitted during the login to the Super User Registration page or the mail settings page.

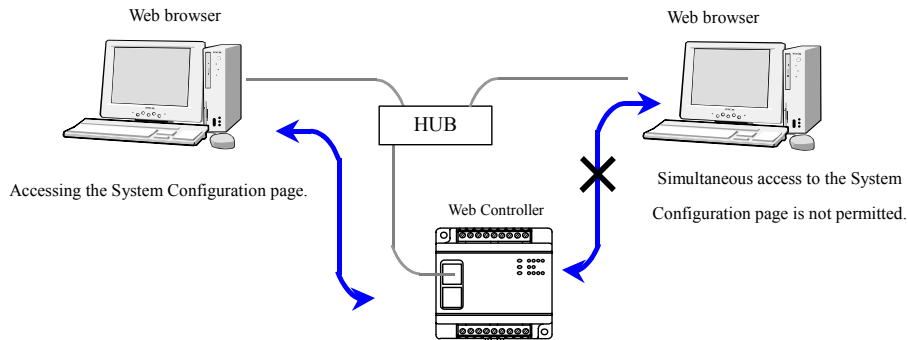

Figure 13.31 Access control (Simultaneous access prohibited)

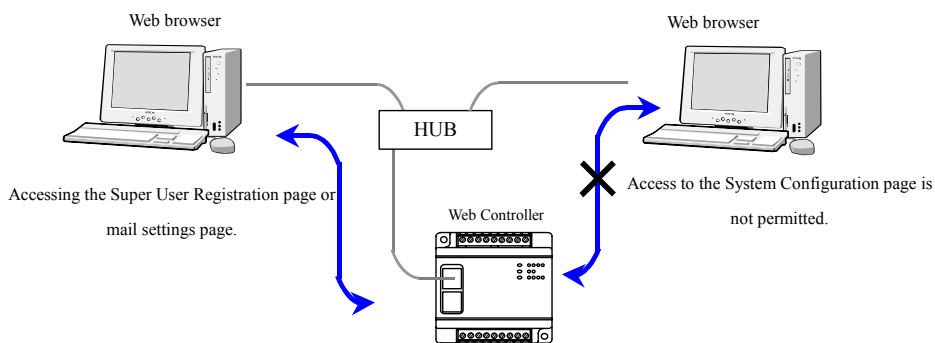

Figure 13.32 Access control

### (2) Access timeout

If no operation is performed for 5 minutes after the login to the System Configuration page from a Web browser, login is forced. If this is the case, log in again by entering a password.

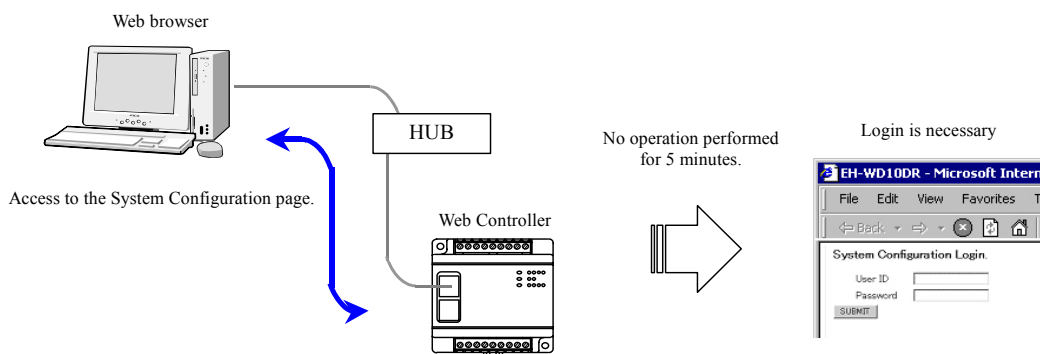

Figure 13.33 Access timeout



***MEMO***

# Chapter 14 Web Controller Extension HTML Tags

## 14.1 HTML Extension tags

In order to read out values on data memory in Web Controller via a Web browser, users need to create an HTML file conforming to the HTML tags which have been extended based on our original specifications (“extension tags”), and also need to register HTML files (“data read HTML files”) in Web Controller.

When Web Controller receives a browse request for an HTML file, CGI analyzes the HTML file, and checks if the file has an extension tag. If the HTML file contains an extension tag, CGI retrieves various information including the values on data memory and login information, and create a temporary HTML file to be sent back. Web server sends back the temporary HTML file to the Web browser.

This means that users can read out values on data memory in Web Controller via a Web browser or access the files for which they are authorized to access by using CGI and extension tags.

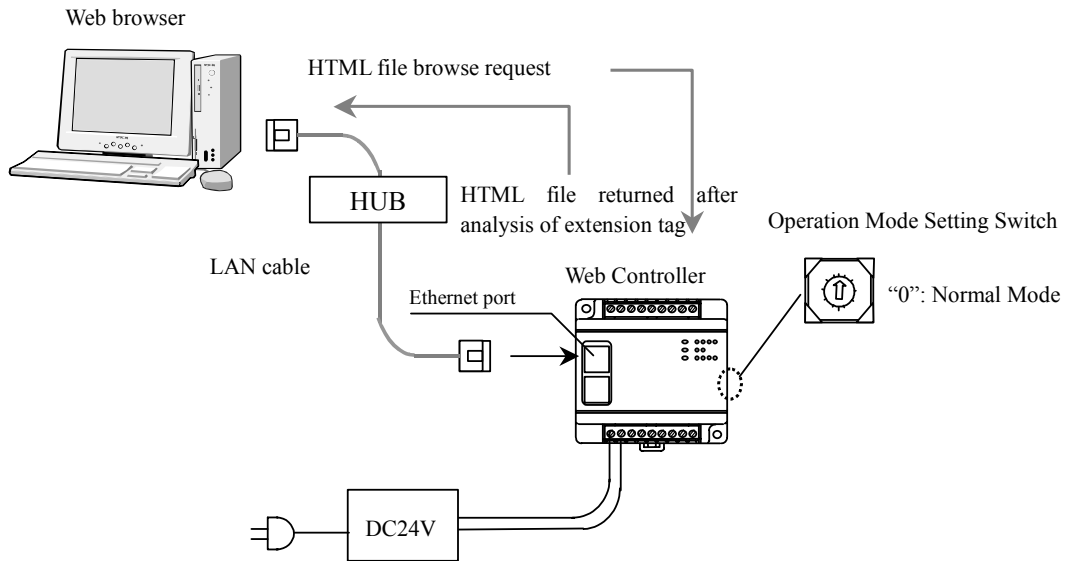

Figure 14.1 Browsing files in Web Controller

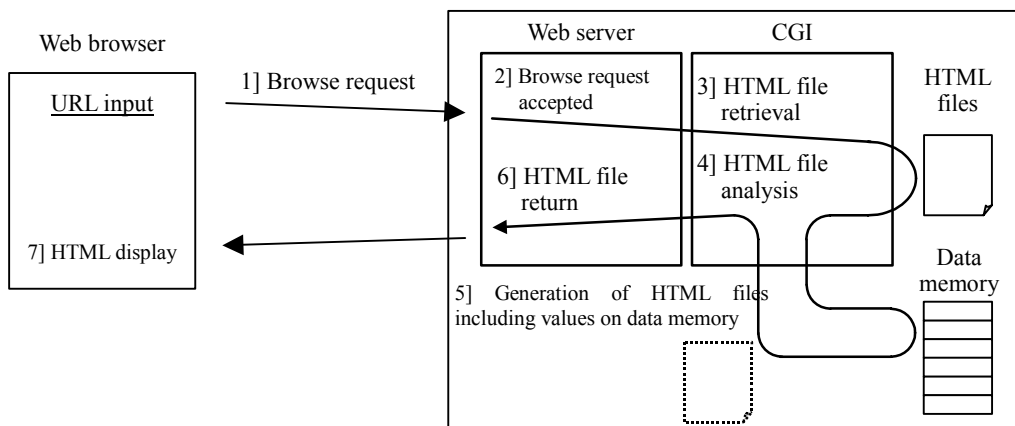

Figure 14.2 Reading out the values and various information using extension tags

## 14.2 Types of Extension tags

Following four types can be specified as an extension tag.

Table 14.1 Types of extension tags

	Name of extension tag	Application	Sample tag statement
1]	I/O Monitor tag	Retrieval of values stored on data memory	<%IO Y 100 %>
2]	Login information transfer tag	Takes over login information to the files for which users are authorized to access.	<%IO SESSIONID %>
3]	Logout tag	Logout	<%IO LOGOUT %>
4]	I/O pass tag	To set if a password is required or not for I/O set.	<%IO IOPASS 0 %>

The following are a sample HTML file with extension tag statements, and a sample screen displayed in a Web browser.

Preparation of HTML files using an editor

Web browser screen display

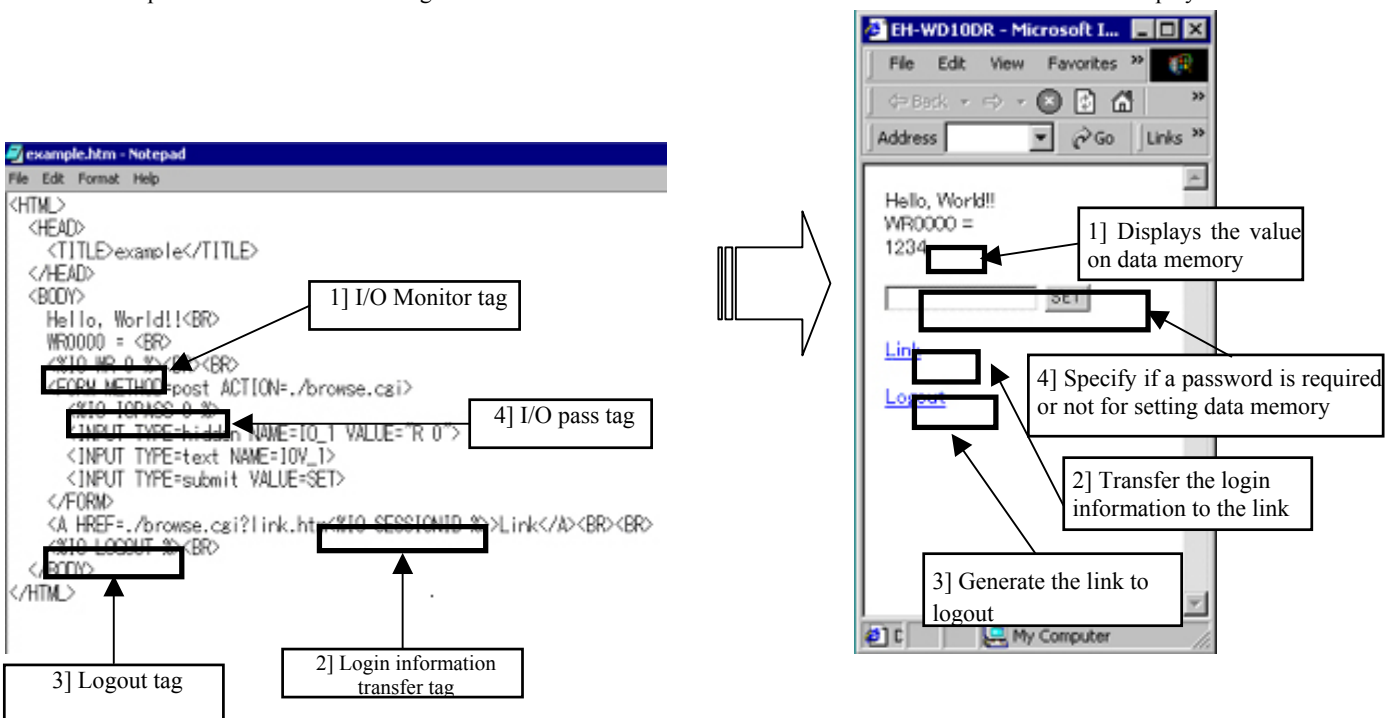

Figure 14.3 Extension tags and display examples

HTML files start with <HTML> tag and end with </HTML> tag. Statements between <HEAD> tag and </HEAD> tag describe the document information of the HTML file including a title. Statements between <BODY> tag and </BODY> tag indicate the part displayed on a Web browser. <BR> tag used in the example inserts a line break at a specified place. <FORM> tag and <INPUT> tag are used to send values to CGI. The information described between <FORM> tag and </FORM> tag is sent to CGI. Web Controller uses the tag to set values to data memory. Refer to “Chapter 15 Setting values on data memory via a Web browser” for details. <A> tag is used to specify a link to a file. Character strings between <A> tag and </A> tag are displayed as a link. Refer to commercially available instruction manuals on HTML tags for details.

## 14.3 I/O Monitor tags

Values on data memory can be displayed on a Web browser using I/O monitor tags as in the following table.

Table 14.2 What users can do with I/O Monitor tags

	Description
1	Display values on data memory numerically. Binary/decimal/hexadecimal/signed decimal can be specified.
2	Character strings are displayed based on the value of bit data.
3	Performs AND operation between the value on data memory and specified value, and displays the result numerically.
4	Performs AND operation between the value on data memory and specified value, and displays the result as character strings.
5	Displays the character strings set with comment tag.

The following table describes the types of data memory.

Table 14.3 Types of data memory

Types of data memory	Description
Bit data	1 bit data either "0" or "1."
Word data	16 bit data (32 bit when double word data is used.)
Comment tag	0 - 128 byte character strings.

### (1) Format of I/O Monitor tags

The following table describes the format of I/O monitor tag.

Table 14.4 Format of I/O Monitor tags

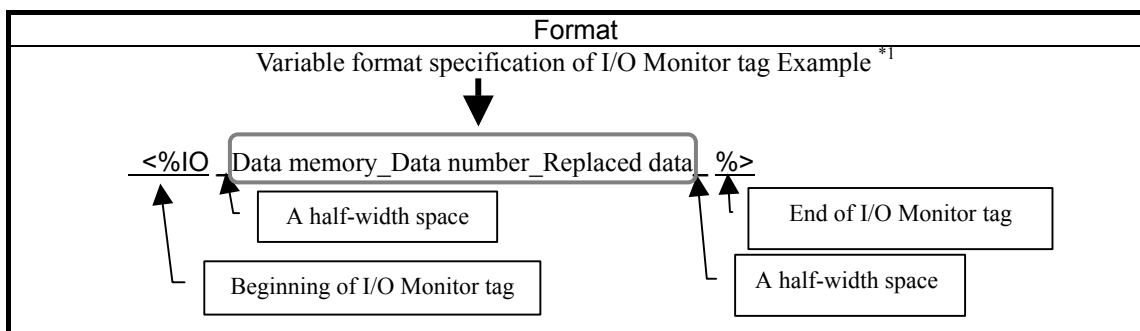

\*1: This is the I/O monitor tag variable format specification when bit data is specified for the data memory. Refer to the following pages for details.

(2) Format of I/O Monitor tag and display examples on a Web browser

I/O monitor tag variable format specification is different depending on the data on data memory (bit data, word data, or comment tag.) A half-width space should be used to separate variables in the format.

- When bit data is specified for the data memory

Table 14.5 Bit data - I/O Monitor tag format

Format		
<u>&lt;%IO _Data memory_Data number_Replaced data_ %&gt;</u> (“ ” means a half-width space.)		
Variables	Contents	Remarks
Data memory	Supports the following 14 types as bit data.  X, Y, R, M, DIF, DFN, MCS, MCR, TD, SS, CU, CTU, CTD and CL.	Essential
Data number	The following is the range of data numbers which can be specified with data memory.  <Common> R            000 - 7FF (Specify using 1 - 3 one byte hexadecimal digits* <sup>1</sup> .) M            0 - 3FFF (Specify using 1 - 4 one byte hexadecimal digits* <sup>1</sup> .) DIF and DFN    0 - 511 (Specify using 0 - 3 decimal numbers.) MCS and MCR    0 - 49 (Specify using 0 - 2 decimal numbers.) TD, SS and CU 0 - 255 (Specify using 0 - 3 decimal numbers.) CTU, CTD and CL  <10 points type (EH-WD10DR)> X            000 - 005 (Specify using 3 one byte decimal numbers.) Y            100 - 103 (Specify using 3 one byte decimal numbers.)  <23 points type (EH-WA23DR)> X            000 - 012* <sup>2</sup> (Specify using 3 one byte decimal numbers.) Y            100 - 109* <sup>2</sup> (Specify using 3 one byte decimal numbers.)	Essential
Replaced Data	According to the value of data memory, any character strings can be displayed. When the value stored on the data memory is “1”, character strings specified in “True Character String” is displayed. When the value stored on the data memory is “0,” character strings specified in “False Character String” is displayed.  Replaced data can be specified as follows: \$True Character String\$:False Character String\$ Characters except “\$” can be specified to be displayed as “True Character String,” and “False Character String.” (“\$” cannot be used, because it is used as a separating character.) 0 - 16 one byte characters or 0 - 8 double-byte characters can be specified (16 bytes in total). * Note: Make sure not to exceed 16 bytes when both one byte characters and double-byte characters are specified.  Example) \$ON:\$OFF\$	Do not necessarily be specified.

\*1: Make sure to use upper cases when alphabets are used. (Example: FF)

\*2: This is data number of the basic unit. A data number of an extension unit is a number of the I/O assignment. Therefore, specify the assigned I/O number.

- Format of I/O Monitor tag and display examples on a Web browser

Table 14.6 Bit data - I/O Monitor tag format samples

I/O Monitor tag format	Web browser display
X000 = <%IO X 000 %>	X000 = 1 (When X000 = 1 )
Y103 = <%IO Y 103 %>	Y103 = 0 (When Y103 = 0)
R0 = <%IO R 0 %>	R0 = 1 (When R0 = 1)
M100 = <%IO M 100 %>	M100 = 0 (When M100 = 0)
X005 = <%IO X 005 \$ONS:\$OFF\$ %>	X005 = ON (When X005 = 1) X005 = OFF (When X005 = 0)
Y101 = <%IO Y 101 \$OK:\$NG\$ %>	Y101 = OK (When Y101 = 1) Y101 = NG (When Y101 = 0)
R10 = <%IO R 10 \$\$:\$1234567890ABCDEF\$ %>	R10 = (When R10 = 1) R10 = 1234567890ABCDEF (When R10 = 0)
M3FFF = <%IO M 3FFF \$RUNS:\$STOP\$ %>	M3FFF = RUN (When M3FFF = 1) M3FFF = STOP (When M3FFF = 0)

```

<HTML>
<HEAD>
  <TITLE>bit data</TITLE>
</HEAD>

<BODY>
  X000 = <%IO X 000 %><BR>
  <BR>
  Y103 = <%IO Y 103 %><BR>
  <BR>
  R0 = <%IO R 0 $ONS:$OFF$ %><BR>
  <BR>
  M10 = <%IO M 10 $1234567890ABCDEF$ $$ %><BR>
  M10 = <%IO M 10 $$:$1234567890ABCDEF$ %><BR>
</BODY>
</HTML>

```

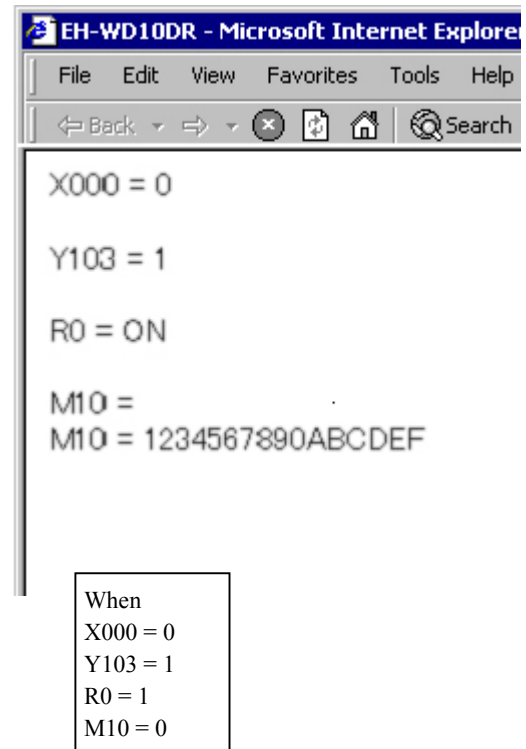

Figure 14.4 Examples of HTML statements and Web browser display

- When bit data or double word data is specified for the data memory

Table 14.7 Word data / Double word data - I/O Monitor tag format

Format		
<p><u>&lt;%IO _Data memory_Data number_Output type_Comparison data_Replaced data_ %&gt;</u> (“ ” means a half-width space.)</p>		
Variables	Contents	Remarks
Data memory	<p>Supports the following 5 types as word data. WX, WY, WR, WM or TC.</p> <p>Supports the following 4 types as double word data. DX, DY, DR and DM.</p>	Essential
Data number	<p>The following is the range of data numbers which can be specified with data memory.</p> <p>&lt;Common&gt;                      WM 0 - 3FF (Specify using 1 to 3 one byte hexadecimal digits*<sup>1</sup>.)                      TC 0 - 255 (Specify using 3 one byte decimal numbers.)                      DX 00 (Cannot specify other than 00.)                      DY 10 (Cannot specify other than 10.)                      DM 0 - 3FE (Specify using 1 - 3 one byte hexadecimal digits*<sup>1</sup>.)</p> <p>&lt;10 points type (EH-WD10DR)&gt;                      WX 00 (Cannot specify other than 00.)                      WY 10 (Cannot specify other than 10.)                      WR 0 - 3FFF, F000 - F19F (Specify using 1 to 4 one byte hexadecimal digits*<sup>1</sup>.)                      DR 0 - 3FFE, F000 - F19E (Specify using 1 to 8 one byte hexadecimal digits*<sup>1</sup>.)</p> <p>&lt;23 points type (EH-WA23DR)&gt;                      WX 00, 30, 31*<sup>3</sup> (Cannot specify other than 00.)                      WY 10, 40*<sup>3</sup> (Cannot specify other than 10.)                      WR 0 - C3FF, F000 - F19F (Specify using 1 to 4 one byte hexadecimal digits*<sup>1</sup>.)                      DR 0 - C3FE, F000 - F19E (Specify using 1 - 8 one byte hexadecimal digits*<sup>1</sup>.)</p>	Essential
Output Type	<p>Specifies types of the values on a Web browser. The following types can be specified:</p> <p>B (Binary) Displays values using one byte binary digits.                      H (Hexa) Display values using one byte hexadecimal digits*<sup>2</sup>.                      D (Decimal) Display values using one byte decimal numbers (signed numbers are not included).                      S (Signed decimal) Display values using one byte decimal numbers (signed numbers are included).</p> <p>If output type is not specified, values are displayed using one byte hexadecimal digit*<sup>2</sup> as “H” is specified.</p>	Do not necessarily be specified.

<Continues to the next page>

- \*1: Make sure to use upper cases when alphabets are used. (Example: FF)
- \*2: Alphabets are displayed in upper case. (Example: FF)
- \*3: This is a data number of the basic unit. The number of an extension unit is a number of the I/O assignment. Therefore, specify the assigned I/O number.

&lt;Continued from the previous page&gt;

Variables	Contents	Remarks
Comparison data	<p>Performs AND operation between the Comparison data and the value on data memory.</p> <p>Comparison data can be specified as follows:</p> <p>Immediately after “CP=”</p> <p>For word data: 0000 - FFFF (14 one byte hexadecimal numbers*1.)</p> <p>For double word data: 00000000 - FFFFFFFF (8 one byte hexadecimal numbers*1.)</p> <p>Example) CP=FFFF</p>	<p>Do not necessarily be specified.</p> <p>(Essential when replaced data is specified.)</p>
Replaced Data	<p>Be sure to specify Comparison data when specify Replaced data. Output type assignment is disregarded. In this case, character strings specified as Replace data is displayed.</p> <p>Any data can be displayed based on the result of AND operation between the value on the data memory and Comparison data.</p> <p>When the result of AND operation between the value on the data memory and the Comparison data equals to the Comparison data, displays “True Character String,” and displays “False Character String” when it does not.</p> <p>Replaced data can be specified as follows:</p> <p>\$True Character String\$:False Character String\$</p> <p>Characters except “\$” can be specified to be displayed as “True Character String,” and “False Character String.” (“\$” cannot be used, because it is used as a separating character.) 0 to16 one byte characters or 0 to 8 double-byte characters can be specified (16 bytes in total).</p> <p>* Note: Make sure not to exceed 16 bytes when both one byte characters and double-byte characters are specified.</p> <p>Example) \$ON:\$OFF\$</p>	<p>Do not necessarily be specified.</p>



■ Format of I/O Monitor tag and display examples on a Web browser

Table 14.8 Word data / Double word data - I/O Monitor tag examples

I/O Monitor tag format	Web browser display
WR0 = <%IO WR 0 %>	WR0 = ABCD (When WR0 = HABCD)
WM10 = <%IO WM 10 B %>	WM10 = 1010101111001101 (When WM10 = HABCD)
TC255 = <%IO TC 255 H %>	TC255 = ABCD (When TC255 = HABCD)
WRFFF = <%IO WR FFF D %>	WRFFF = 43981 (When WRFFF = HABCD)
WM100 = <%IO WM 100 S %>	WM100 = -21555 (When WM100 = HABCD)
WR10 = <%IO WR 10 CP=FF00 %>	WR10 = AB00 (When WR10 = HABCD)
WM1 = <%IO WM 1 B CP=FF00 %>	WM1 = 1010101100000000 (When M1 = HABCD)
WR100 = <%IO WR 100 D CP=FF00 %>	WR100 = 43776 (When WR100 = HABCD)
WM200 = <%IO WM 200 S CP=FF00 %>	WM200 = -21760 (When WM200 = HABCD)
WX00 = <%IO WX 00 CP=003F \$ALL\$: \$NOT\$ %>	WX00 = ALL (When WX00 = H003F) WX00 = NOT (When WX00 does not equal to H003F)
WY10 = <%IO WY 10 CP= 000F \$OK\$: \$NG\$ %>	WY10 = OK (When WY10 = H000F) WY10 = NG (When WY10 does not equal to H000F)
WRA0 = <%IO WR A0 CP=000F \$\$:1234567890ABCDEF\$ %>	WRA0 = (When WRA0 = H***F, * equals to any hexadecimal numbers*1)  WRA0 = 1234567890ABCDEF (When WRA0 does not equal to H***F, * equals to any hexadecimal numbers *1)
WRB0 = <%IO WR B0 B CP=000F \$\$:1234567890ABCDEF\$ %>	WRB0 = (WRB0 = H***F, * equals to any hexadecimal numbers *1)  WRB0 = 1234567890ABCDEF (When WRB0 does not equal to H***, * equals to any hexadecimal numbers *1)
WM3FF = <%IO WM 3FF CP=FFFF \$ON\$: \$OFF\$ %>	WM3FF = ON (When WM3FF = HFFFF) WM3FF= OFF (When WM3FF does not equal to HFFFF)

\*1: Make sure to use upper cases when alphabets are used. (Example: FF)

```

<HTML>
<HEAD>
  <TITLE>word data</TITLE>
</HEAD>

<BODY>
  WX00 = <%IO WX 00 %><BR>
  WY10 = <%IO WY 10 %><BR>
  <BR>
  WM0 = <%IO WM 0 %><BR>
  WM0 = <%IO WM 0 B %><BR>
  WM0 = <%IO WM 0 H %><BR>
  WM0 = <%IO WM 0 D %><BR>
  WM0 = <%IO WM 0 S %><BR>
  <BR>
  WR10 = <%IO WR 10 %><BR>
  WR10 = <%IO WR 10 CP=FF00 %><BR>
  WR10 = <%IO WR 10 B CP=FF00 %><BR>
  WR10 = <%IO WR 10 D CP=FF00 %><BR>
  WR10 = <%IO WR 10 S CP=FF00 %><BR>
  <BR>
  WM100 = <%IO WM 100 %><BR>
  WM100 = <%IO WM 100 CP=000F $OK$:SNG$ %><BR>
  WM100 = <%IO WM 100 D CP=000F $OK$:SNG$ %><BR>
</BODY>
</HTML>

```

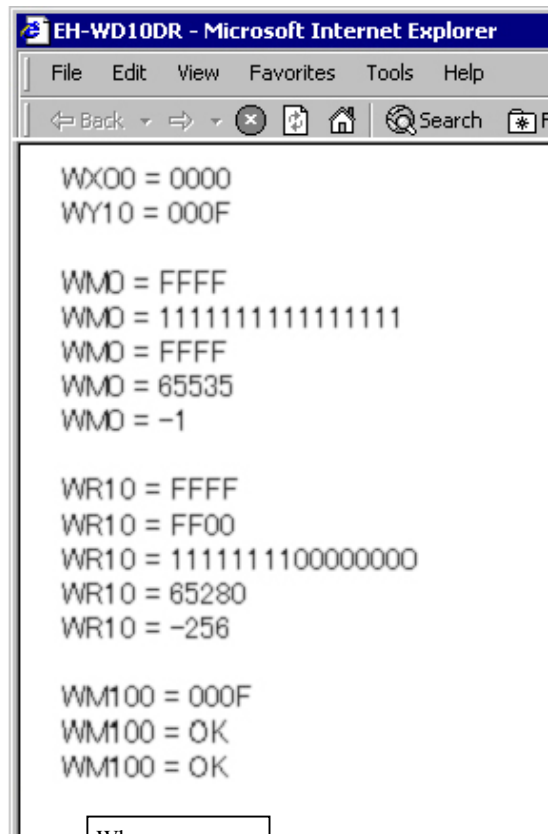

When
WX00 = 0000
WY10 = 000F
WM0 = FFFF
WR10 = FFFF
WM100 = 000F

Figure 14.5 Examples of HTML statements and Web browser display

- When comment tag is specified for the data memory

Table 14.9 Comment tag - I/O Monitor tag format

Format		
<code>&lt;%IO _Data memory_ Data number_ %&gt;</code> (“_” means a half-width space.)		
Variables	Contents	Remarks
Data memory	CT	Essential
Data number	The following is the range of data numbers which can be specified for CT.  CT    from 0 to 255 (Specify using 1 to 3 one byte decimal numbers.)	Essential

0 - 128 one byte characters or 0 - 64 double-byte characters can be specified (128 bytes in total) for comment tag. Refer to “Chapter 15 Setting values on data memory via a Web browser” for setting comment tags.

\* Note: Make sure of not exceeding 128 bytes when both one byte characters and double-byte characters are specified.

- \* Format of I/O Monitor tag and display examples on a Web browser

Table 14.10 Comment tags - I/O Monitor tag samples

I/O Monitor tag format	Web browser display
<code>&lt;%IO CT 0 %&gt;</code>	Comment (When CT0 = Comment )

```

<HTML>
<HEAD>
  <TITLE>comments tag</TITLE>
</HEAD>

<BODY>
  CT0 = <%IO CT 0 %><BR>
</BODY>
</HTML>
    
```

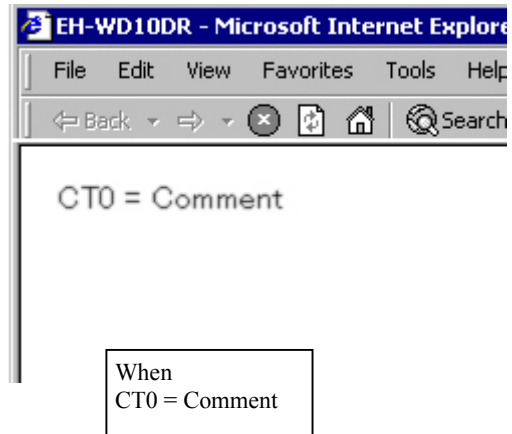

Figure 14.6 Examples of HTML statements and Web browser display

(3) I/O Monitor tag optional functions

I/O Monitor tag has an optional function to include the value retrieved with I/O Monitor tag in the HTML tag immediately after that.

This option can be specified as follows:

Table 14.11 I/O Monitor tag - format for optional functions

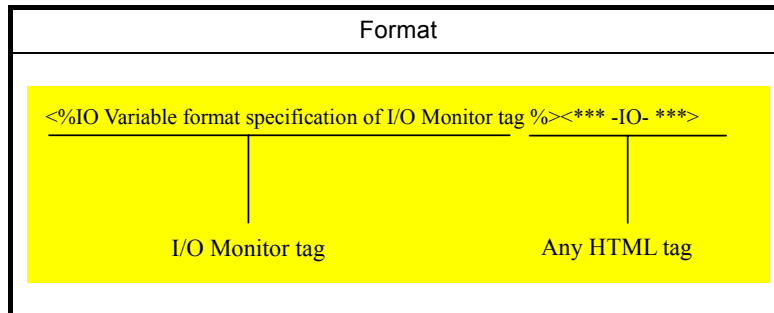

■ Sample use of I/O Monitor tag optional function and display on a Web browser

Table 14.12 I/O Monitor tag - sample use of option

I/O Monitor tag format	Web browser display
<%IO X 000 \$CHECKED\$:\$ \$ %> <INPUT TYPE="checkbox" -IO->	When X000 = 1, the checkbox is checked.
<%IO R 0 \$REDS:\$BLUES \$ %> <FONT COLOR=-IO->R0</FONT>	When R0 = 1, "R0" is displayed in red. When R0 = 0, "R0" is displayed in blue.
<%IO WM 3FF %> <INPUT TYPE="text" VALUE="-IO->	The value of WM3FF is appeared in the textbox. (When WM3FF = HABCD, "ABCD" is appeared.)
<%IO WR 100 CP=00FF \$REDS:\$BLUES \$ %> <BUTTON STYLE="COLOR:-IO->WR100</BUTTON>	When WR100 = H**FF ("**" can be any characters), WR100 is displayed as a red button. When WR100 does not equal to H**FF ("**" can be any characters), WR100 is displayed as a blue button.

```

<HTML>
<HEAD>
  <TITLE>option -IO-</TITLE>
</HEAD>

<BODY>
  R0:
  <%IO R 0 $CHECKED$:$ $ %>
  <INPUT TYPE=checkbox -IO-><BR><BR>

  CT0 =
  <%IO CT 0 %>
  <INPUT TYPE=text VALUE="-IO-><BR><BR>

  <%IO WR 0 CP=00FF $REDS:$BLUES $ %>
  <FONT COLOR=-IO->WR0</FONT>
</BODY>
</HTML>
    
```

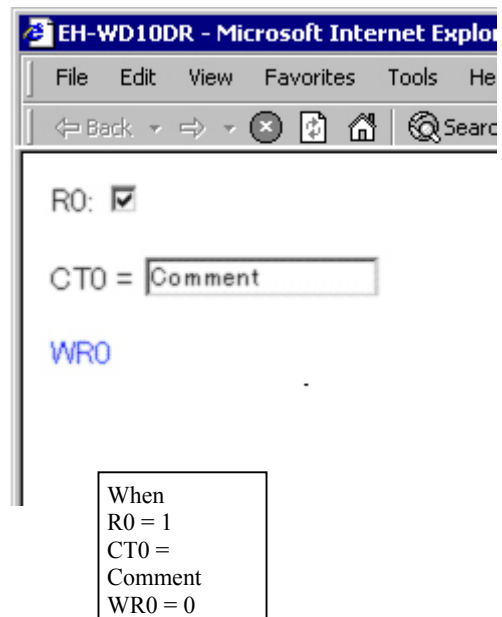

Figure 14.7 Examples of HTML statements and Web browser display

## 14.4 Login information transfer tag

Using Login information transfer tag, the login information can be transferred when accessing files with an access control. When making links to other files in Web Controller using <FRAME> tag, <A> tag, or automatic jump function to reference pages, this tag is used after the specified file.

The following table describes the format of Login information transfer tag.

Table 14.13 Format of Login information transfer tag

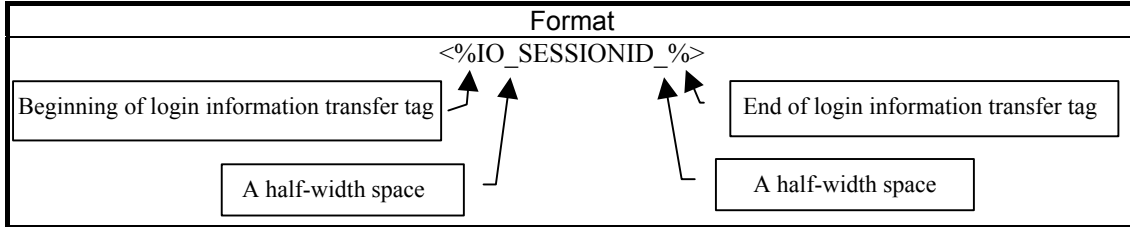

### ⚠ Caution!!

Make sure to specify as follows when using screen refresh function (<META HTTP-EQUIV="REFRESH" CONTENT="5">) on the screen to set values to HTML files with an access control or data memory.

<META HTTP-EQUIV="REFRESH" CONTENT="5;URL=../browse.cgi?xxx.htm<%IO\_SESSIONID\_%>">  
 (xxx.htm is a file name)

This assignment is necessary, because the HTML file, which is referred to after the login to a file with an access control or after setting values to data memory, is controlled by CGI, and a Web browser does not have information on the referenced file.

```
<HTML>
<HEAD>
<TITLE>SESSION ID</TITLE>
<META HTTP-EQUIV="REFRESH" CONTENT="5;URL=../browse.cgi?session.htm<%IO_SESSIONID_%>">
</HEAD>

<BODY>
<A HREF=../browse.cgi?session.htm<%IO_SESSIONID_%>>Link to session.htm</A>
</BODY>
</HTML>
```

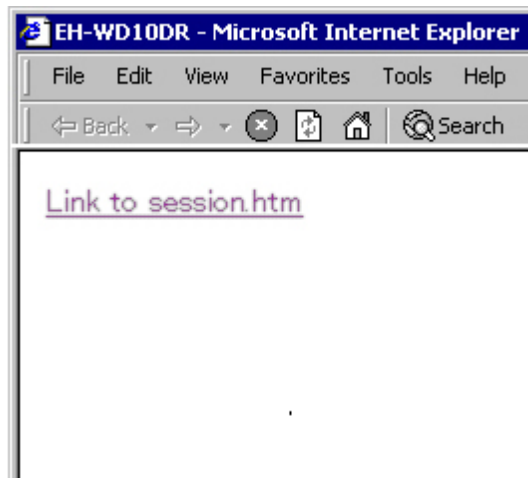

Figure 14.8 Examples of HTML statements and Web browser display

## 14.5 Logout tag

Logout tag prepares a link to log out from the login status. Logout process is performed by clicking the link. If a Web browser is closed without logging out, it is not possible to access files with an access control after the logout process due to timeout is performed (5 minutes after the last access). Therefore, make sure to include a logout tag when preparing an HTML file with an access control.

Logout tag can be specified as follows:

Table 14.14 Logout tag format

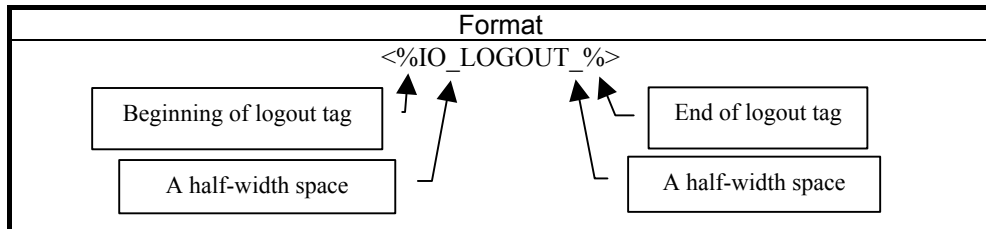

```
<HTML>
<HEAD>
  <TITLE>Logout</TITLE>
</HEAD>

<BODY>
  <%IO LOGOUT %>
</BODY>
</HTML>
```

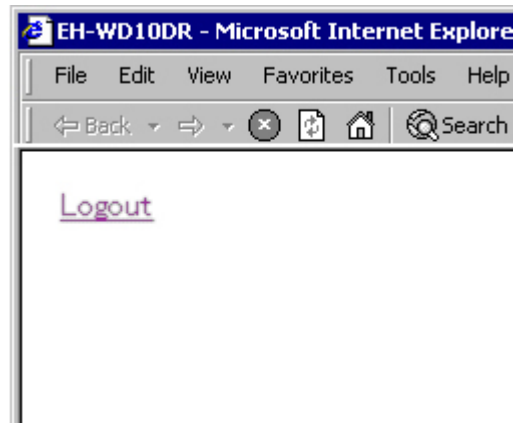

Figure 14.9 Examples of HTML statements and Web browser display

## 14.6 I/O pass tag

I/O pass tag specifies if a password is required for I/O set or not. It is used to put a password protection for setting values on important data memory. Therefore, make sure to include I/O pass tag when preparing an HTML file to perform I/O set. HTML files which perform I/O set without I/O pass tag causes an error. Include I/O pass tag between <FORM> tag and </FORM> tag in the format specified below.

Table 14.15 Format of I/O pass tag

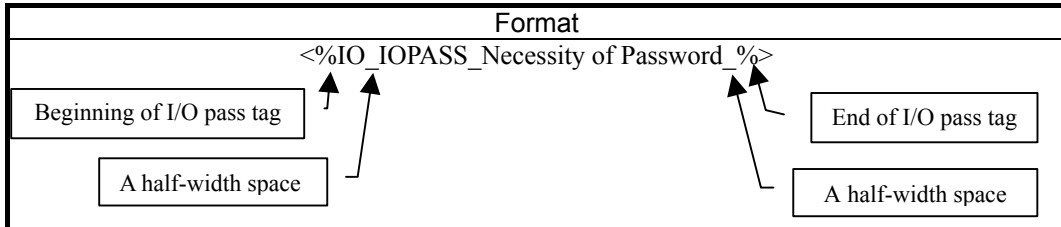

Table 14.16 I/O pass tag format

Format		
<%IO_IOPASS_Necessity of Password_%> (“_” means a half-width space.)		
Variables	Contents	Remarks
Necessity of password	Specify by “0” or “1.”  0: Password is not required for I/O set. 1: Password is required for I/O set.	Essential

```

<HTML>
<HEAD>
<TITLE>IO pass</TITLE>
</HEAD>
<BODY>
<FORM METHOD=post ACTION=./browse.cgi>
<%IO_IOPASS 0 %>
No password<BR>Y100<BR>
<INPUT TYPE=hidden NAME=IO_1 VALUE="Y 100">
<INPUT TYPE=text NAME=IOV_1><BR>
<INPUT TYPE=submit VALUE=SET><BR>
</FORM>
<BR>
<FORM METHOD=post ACTION=./browse.cgi>
<%IO_IOPASS 1 %>
password<BR>Y100<BR>
<INPUT TYPE=hidden NAME=IO_1 VALUE="Y 100">
<INPUT TYPE=text NAME=IOV_1><BR>
<INPUT TYPE=submit VALUE=SET><BR>
</FORM>
</BODY>
</HTML>
    
```

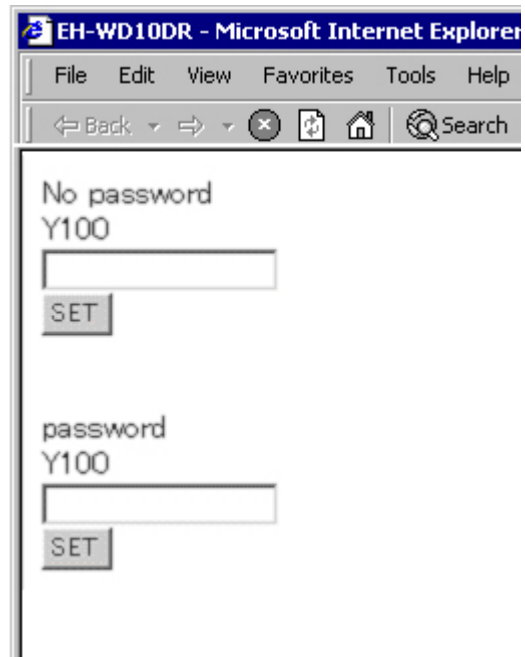

Figure 14.10 Examples of HTML statements and Web browser display

By clicking the [submit] button for which I/O set password is required, the following I/O set password input screen will be displayed. Enter the I/O set password in the textbox, and click the [SUBMIT] button. The value is set to the data memory after the I/O set password is authenticated. If the I/O set password does not match, the I/O set password re-request screen with an error message will be displayed. Enter a correct I/O set password, and click the [SUBMIT] button. Click the [BACK] button to return to the HTML file which was referred before the I/O set.



The screenshot shows a Microsoft Internet Explorer browser window with the title "EH-WD10DR - Microsoft Internet Explorer". The menu bar includes "File", "Edit", "View", "Favorites", "Tools", and "Help". The address bar shows navigation buttons for "Back", "Forward", "Stop", "Home", and "Search". The main content area displays the heading "Browse IOset Password." followed by a text input field labeled "Password". Below the input field are two buttons: "SUBMIT" and "BACK".

Figure 14.11 I/O set password input screen



The screenshot shows a Microsoft Internet Explorer browser window with the title "EH-WD10DR - Microsoft Internet Explorer". The menu bar includes "File", "Edit", "View", "Favorites", "Tools", and "Help". The address bar shows navigation buttons for "Back", "Forward", "Stop", "Home", and "Search". The main content area displays the heading "Browse IOset Password." followed by the error message "IO password error.". Below the error message is a text input field labeled "Password". At the bottom are two buttons: "SUBMIT" and "BACK".

Figure 14.12 I/O set password re-request screen



## 14.7 Extension tag error code

Extension tags, which do not conform to the specifications, cause an error. Extension tags with an error will be displayed on a Web browser with an error code. (Symbols in the extension tag with an error are replaced with HTML tags for the display on a Web browser.)

The following table shows error codes and description.

Table 14.17 Error codes and contents

Error code	Contents of the error
200	Format of the extension tag is wrong.
201	Assignment of data memory is wrong.
202	Assignment of data number is wrong.
203	
204	
205	
206	Output type is specified for bit data on data memory.
207	Assignment of output type is wrong.
208	
209	Comparison data is specified for bit data on data memory.
210	Assignment of comparison data is wrong.
211	
212	
213	Assignment of replaced data is wrong.
214	
215	
216	
217	
218	Word data is specified for data memory, and replaced data is specified, but there is no comparison data.
219	-
220	-
221	Duplicated definition of output type.
222	Duplicated definition of comparison data.
223	Duplicated definition of replaced data.
224	-
225	Assignment of comment tag is wrong.
226	System malfunction.
227	
228	Order of assignment is wrong.
229	Assignment of output type is wrong.
230	Assignment of comparison data is wrong.

It may possible that the above error is caused because I/O allocation is not performed. Be sure to perform I/O allocation using LADDER EDITOR for Windows<sup>(R)</sup> before use. Refer to “Chapter 2 – Programming” in Controller Manual for the way of I/O allocation.

## 14.8 Remarks for HTML tag

When preparing a HTML file, be careful about followings.

(1) Link to other files.

Please note that there is a difference in using links to other files with <FRAME> tag, <A> tag and <IMG> tag between 10 points type and 23 points.

▪ 10 points type

The following table describes how to specify links to all files.

Table 14.18 Statement example

	URL Statement	Remarks
1	<pre>&lt;A HREF="/browse.cgi?xxx.yyy"&gt;</pre> <p style="margin-left: 100px;">└─ File name ("yyy" is a extension.)</p>	Use the login information transfer tag when setting an access authorization for a file made to link. Refer to "14.4 - Login information transfer tag" for details.

▪ 23 points type

Specification of a link to HTML file is different from links to other files.

(i) HTML file

Be sure to enter "/browse.cgi" before a name of the file made to link

Table 14.19 Statement example

	URL Statement	Remarks
1	<pre>&lt;A HREF="/browse.cgi?xxx.htm"&gt;</pre> <p style="margin-left: 100px;">└─ File name ("html" is also available as an extension.)</p>	Use the login information transfer tag when setting an access authorization for a file made to link. Refer to "14.4 - Login information transfer tag" for details.

(ii) Other files except HTML file like an image file.

Specify only a file name, in order to link to other files except HTML file, such as image files and Java applets.

Table 14.20 Statement example

	URL Statement	Remarks
1	<pre>&lt;A HREF="/xxx.yyy"&gt;</pre> <p style="margin-left: 100px;">└─ File name ("yyy" is an extension.)</p>	Displays a file even if an access authorization is set for a file made to link.

***MEMO***

# Chapter 15 Setting values from a Web browser to data memory

## 15.1 Data memory setting program

To set values on data memory in Web Controller via a Web browser, users need to create an HTML file conforming to <FORM> tag, <INPUT> tag and <SELECT> tag as well as to <INPUT> tag attribute format, <SELECT> tag attribute format and I/O pass tag that we independently defined, and to register HTML files (“dataset HTML files”) in Web Controller.

When receiving a browse request for a dataset HTML file, CGI returns the requested HTML file. Then, the Web browser displays a page including input boxes, checkboxes, pull-down menus and others. Users enter or select values they want to set, and submit the dataset request on this page. When Web Controller receives the dataset request, it analyzes whether the I/O pass tag is defined to require a password. If a password is required, the Web browser displays a password authentication page. When a password is entered on the password authentication page and accepted, the submitted data is written in the specified I/O number area on data memory, and the referenced page is displayed on the Web browser again. If no password is required, the submitted data is written in the specified I/O number area on data memory, and the referenced page is displayed on the Web browser again.

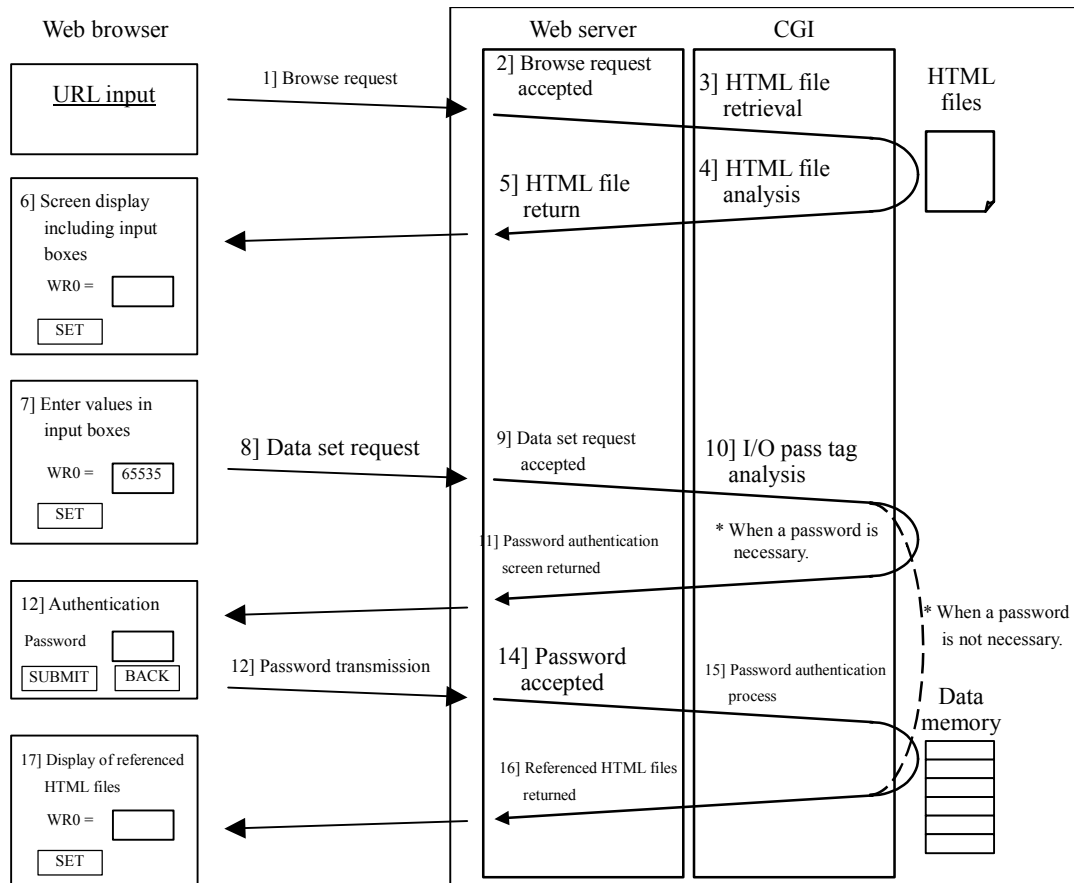

Figure 15.1 Setting values on data memory via a Web browser

## 15.2 HTML statement to pass an argument to the data memory setting program

Table 15.1 Data memory setting program - HTML statement

HTML statement example		
<pre>&lt;FORM METHOD=post ACTION=../browse.cgi&gt; &lt;%IO IOPASS 0 %&gt; &lt;INPUT TYPE=hidden NAME=Label VALUE="Data memory_Data number_Input type_Designation of consecutive data memory for setting values"&gt; &lt;INPUT TYPE=text NAME=Value&gt; &lt;INPUT TYPE=submit VALUE=SET&gt; &lt;/FORM&gt;</pre> <p>(_ means a half-width space.)</p> <p><b>Caution!!</b>  <u>Be sure to specify the I/O pass tag to specify the necessity of the I/O set password. Refer to "Chapter 14 Dedicated HTML tags for Web Controller" for details.</u></p> <p><u>&lt;INPUT&gt; tag is used in the example, but &lt;SELECT&gt; tag can also be used. "radio," and "checkbox," can also be used in the TYPE attribute for &lt;INPUT&gt; tag as well as "text." Make sure to specify the value to set using VALUE attribute.</u></p> <p><u>DO NOT specify NAME attribute to the [submit] button.</u></p>		
Variables	Contents	Remarks
Label information	<p>Label information is specified as follows:</p> <p>IO_N  Specify two consecutive values from 1 - 99 (1 - 2 decimal numerals) for the above "N."</p> <p><b>Caution!!</b>  <u>Even if there are multiple &lt;FORM&gt; - &lt;/FORM&gt; statements in an HTML file, make sure to start "N" from "1" each time.</u></p>	Essential
Data memory	<p>Supports the following 14 types.</p> <p>X, Y, R, M  WX, WY, WR, WM, TC  DX, DY, DR, DM  CT</p>	Essential

&lt;Continues to the next page&gt;

&lt;Continued from the previous page&gt;

Variables	Contents	Remarks
Data number	<p>Data numbers which can be specified depend on the data memory. The following is the range of data numbers:</p> <p>&lt;Common&gt;</p> <p>R 000 - 7FF (Specify using 1 to 3 one byte hexadecimal digits*<sup>1</sup>.)</p> <p>M 0 - 3FFF (Specify using 1 to 4 one byte hexadecimal digits*<sup>1</sup>.)</p> <p>WM 0 - 3FF (Specify using 1 to 3 one byte hexadecimal digits*<sup>1</sup>.)</p> <p>TC 0 - 255 (Specify using 1 to 3 one byte decimal numbers.)</p> <p>DM 0 - 3FE (Specify using 1 to 3 one byte hexadecimal digits*<sup>1</sup>.)</p> <p>CT 0 - 255 (Specify using 1 to 3 one byte decimal numbers.)</p> <p>&lt;10 points type (EH-WD10DR)&gt;</p> <p>X 000 - 005 (Specify using 3 one byte decimal numbers.)</p> <p>Y 100 - 103 (Specify using 3 one byte decimal numbers.)</p> <p>WX 00 (Cannot specify other than 00.)</p> <p>WY 10 (Cannot specify other than 10.)</p> <p>WR 0 - 3FFF, F000 - F19F (Specify using 1 to 4 one byte hexadecimal digits*<sup>1</sup>.)</p> <p>DX 00 (Cannot specify other than 00.)</p> <p>DY 10 (Cannot specify other than 10.)</p> <p>DR 0 - 3FFE, F000 - F19E (Specify using 1 to 4 one byte hexadecimal digits*<sup>1</sup>.)</p> <p>&lt;23 points type (EH-WA23DR)&gt;</p> <p>X 000 - 012 (Specify using 3 one byte decimal numbers.)</p> <p>Y 100 - 109 (Specify using 3 one byte decimal numbers.)</p> <p>WX 00 (Cannot specify other than 00.)</p> <p>WY 10 (Cannot specify other than 10.)</p> <p>WR 0 - C3FF, F000 - F19F (Specify using 1 to 4 one byte hexadecimal digits*<sup>1</sup>.)</p> <p>DX 00 (Cannot specify other than 00.)</p> <p>DY 10 (Cannot specify other than 10.)</p> <p>DR 0 - C3FE, F000 - F19E (Specify using 1 to 4 one byte hexadecimal digits*<sup>1</sup>.)</p>	Essential
Input Type	<p>When word data is used for the data memory, the input type can be specified. The following types can be specified:</p> <p>B (Binary) Specify using one byte binary digits.</p> <p>H (Hexa) Specify using one byte hexadecimal digits.</p> <p>D (Decimal) Specify using one byte decimal numbers (signed numbers are not included).</p> <p>S (Signed decimal) Specify using one byte decimal numbers (signed numbers are included).</p> <p>When the input type is not specified, specify the value using one byte hexadecimal digits. (Same when specifying a value for the above "H".)</p> <p><b>Caution!!</b>  <b>Do not specify the input type when bit data or comment tags are used for the data memory.</b></p>	Do not necessarily be specified. (Setting is not permitted depending on the type of data memory.)

&lt;Continues to the next page&gt;

<Continued from the previous page>

Variables	Contents	Remarks
Designation of consecutive data memory for setting values	Specify consecutive data memory for setting values. Designation of consecutive data memory for setting values can be specified as follows:  1 - 99 (1 to 2 one byte decimal numbers.)  If this is not specified, it is regarded to specify "1."	Do not necessarily be specified.
Value	Values can be specified as follows:  IOV_N_M Specify two consecutive values from 1 to 99 (1 to 2 decimal numbers) corresponding to the label information for the above "N". Do not specify "M" when consecutive data memory is not specified. If consecutive data memory is specified for setting values, specify values within the range from 1 to the designated number.	Essential

\*1: Make sure to use upper cases when alphabets are used. (Example: FF)

\*2: This is a data number of the basic unit. A data number of an extension unit is an I/O assignment number. Therefore, specify the assigned I/O number.

## 15.3 A settable value to data memory

A settable value to data memory differs depending on data memory types and input types.

Table 15.2 A settable value to data memory

Data Memory	Input Type	A Settable Value
Bit data	-	0, 1
Word data (Value on line 2 is Double data)	B (binary)	0000000000000000 to 1111111111111111 00000000000000000000000000000000 to 11111111111111111111111111111111
	H (hexadecimal)	0000 to FFFF 00000000 to FFFFFFFF
	D (unsigned decimal)	0 to 65535 0 to 4294967295
	S (signed decimal)	-32768 to 32767 -2147483648 to 2147483647
Comment Tag	-	Character string up to 128 bytes (0 to 128 one-byte characters, 0 to 64 double-byte characters *Note: Make sure of not exceeding 128 bytes when both one-byte characters and double-byte characters are specified.)

## 15.4 Remarks

(1) URL after the data set

URL will change to the following after a value is set to data memory. Therefore, please note that reference files should be specified to use screen refresh function or update function on a Web browser.

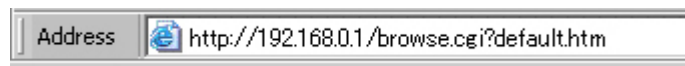

Figure 15.2 Reference URL before the data set

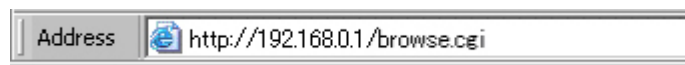

Figure 15.3 Reference URL after the data set

(2) To delete comment tag

To delete the characters set in the comment tag "CT," set a half-width space to the comment tag "CT."

(3) Operation in case of an error

An error screen is displayed when HTML tags have an error such as that specify an invalid value to data memory or the I/O pass tag is not specified.



## 15.5 HTML tag examples for data memory settings

- HTML file to set a value to “Y100.”  
Enter the value in the textbox and click [SET] to set the value.  
(As the allowable data is bit data, the value should be either “0” or “1.”)

HTML statement example

```
<HTML>
<HEAD>
  <TITLE>Set 1</TITLE>
</HEAD>
<BODY>
  <FORM METHOD=post ACTION=../browse.cgi>
    <%IO IOPASS 0 %>
    <INPUT TYPE=hidden NAME=IO_1 VALUE="Y 100">
    Y100 = <INPUT TYPE=text NAME=IOV_1>
    <INPUT TYPE=submit VALUE=SET>
  </FORM>
</BODY>
</HTML>
```

Web browser display

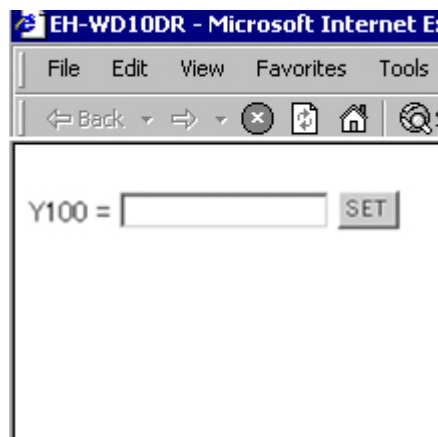

Figure 15.4 HTML tag example (1) for data memory setting

- HTML file to set a value to “R100” and “M100.”

Enter values in the textboxes corresponding to “R100” and “M100” respectively, and click [SET] to set the values. (As the allowable data is bit data, the value should be either “0” or “1.”)

HTML statement example

```
<HTML>
<HEAD>
  <TITLE>Set 2</TITLE>
</HEAD>

<BODY>
  <FORM METHOD=post ACTION=../browse.cgi>
    <%IO IOPASS 0 %>
    <INPUT TYPE=hidden NAME=IO_1 VALUE="R 100">
    R100 = <INPUT TYPE=text NAME=IOV_1><BR>
    <INPUT TYPE=hidden NAME=IO_2 VALUE="M 100">
    M100 = <INPUT TYPE=text NAME=IOV_2><BR>
    <INPUT TYPE=submit VALUE=SET>
  </FORM>
</BODY>
</HTML>
```

Web browser display

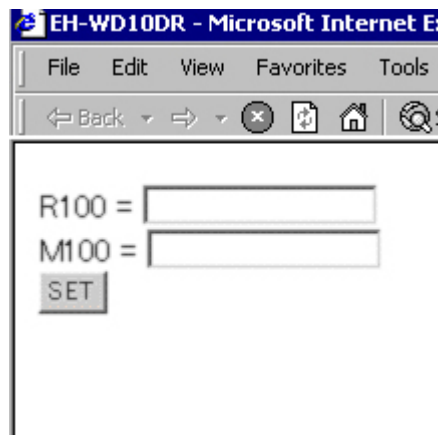

Figure 15.5 HTML tag example (2) for data memory setting

- HTML file to set values to two consecutive data memory starting from “Y100.”  
Enter values in the textboxes corresponding to two consecutive data memory starting from “Y100,” (Y100 and Y101), and click [SET] to set the values.  
(As the allowable data is bit data, the value should be either “0” or “1.”)

HTML statement example

```
<HTML>
<HEAD>
  <TITLE>Set 3</TITLE>
</HEAD>

<BODY>
  <FORM METHOD=post ACTION=./browse.cgi>
    <%IO IOPASS 0 %>
    <INPUT TYPE=hidden NAME=IO_1 VALUE="Y 100 2">
    Y100 = <INPUT TYPE=text NAME=IOV_1_1><BR>
    Y101 = <INPUT TYPE=text NAME=IOV_1_2><BR>
    <INPUT TYPE=submit VALUE=SET>
  </FORM>
</BODY>
</HTML>
```

Web browser display

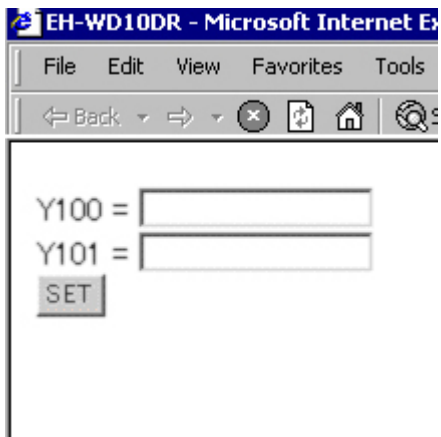

Figure 15.6 HTML tag example (3) for data memory setting

- HTML file to specify input types.

This file specifies a hexadecimal digit to “WR0” (when input type is not specified), a binary digit to “WR1,” a hexadecimal digit to “WR2,” a decimal digit to “WR3,” and a signed decimal digit to “WR4.”

Enter values in the textboxes corresponding to WR0 to WR4 respectively, and click [SET] to set the values. (Allowable data depends on the specified input type.)

#### HTML statement example

```
<HTML>
<HEAD>
  <TITLE>Set 4</TITLE>
</HEAD>

<BODY>
  <FORM METHOD=post ACTION=../browse.cgi>
    <%IO IOPASS 0 %>
    <INPUT TYPE=hidden NAME=IO_1 VALUE="WR 0">
    WR0 = <INPUT TYPE=text NAME=IOV_1><BR>
    <INPUT TYPE=hidden NAME=IO_2 VALUE="WR 1 B">
    WR1(B) = <INPUT TYPE=text NAME=IOV_2><BR>
    <INPUT TYPE=hidden NAME=IO_3 VALUE="WR 2 H">
    WR2(H) = <INPUT TYPE=text NAME=IOV_3><BR>
    <INPUT TYPE=hidden NAME=IO_4 VALUE="WR 3 D">
    WR3(D) = <INPUT TYPE=text NAME=IOV_4><BR>
    <INPUT TYPE=hidden NAME=IO_5 VALUE="WR 4 S">
    WR4(S) = <INPUT TYPE=text NAME=IOV_5><BR>
    <INPUT TYPE=submit VALUE=SET>
  </FORM>
</BODY>
</HTML>
```

#### Web browser display

The screenshot shows a web browser window titled "EH-WD10DR - Microsoft Internet Explorer". The browser's address bar is empty. The main content area displays a form with the following elements:

- WR0 =
- WR1(B) =
- WR2(H) =
- WR3(D) =
- WR4(S) =
- SET

Figure 15.7 HTML tag example (4) for data memory setting

- HTML file to set a value using a checkbox  
A checkbox can be used to set a value to “Y100.”  
Using this HTML file, “1” can be set to “Y100” by checking the checkbox and click [SET].

HTML statement example

```
<HTML>
<HEAD>
  <TITLE>Set 5</TITLE>
</HEAD>

<BODY>
  <FORM METHOD=post ACTION=../browse.cgi>
    <%IO IOPASS 0 %>
    <INPUT TYPE=hidden NAME=IO_1 VALUE="Y 100">
    Y100<BR>
    <INPUT TYPE=checkbox NAME=IOV_1 VALUE=1>:ON<BR>
    <INPUT TYPE=submit VALUE=SET>
  </FORM>
</BODY>
</HTML>
```

Web browser display



Figure 15.8 HTML tag example (5) for data memory setting

- HTML file to set a value using a radio button

A radio button can be used to set a value to “Y100.”

Using this HTML file, “1” can be set to “Y100” by checking the radio button to specify “ON,” and click [SET].

Using this HTML file, “0” can be set to “Y100” by checking the radio button to specify “OFF,” and click [SET].

#### HTML statement example

```
<HTML>
<HEAD>
<TITLE>Set 6</TITLE>
</HEAD>

<BODY>
<FORM METHOD=post ACTION=../browse.cgi>
<%IO IOPASS 0 %>
<INPUT TYPE=hidden NAME=IO_1 VALUE="Y 100">
Y100<BR>
<INPUT TYPE=radio NAME=IOV_1 VALUE=1>:ON<BR>
<INPUT TYPE=radio NAME=IOV_1 VALUE=0>:OFF<BR>
<INPUT TYPE=submit VALUE=SET>
</FORM>
</BODY>
</HTML>
```

#### Web browser display

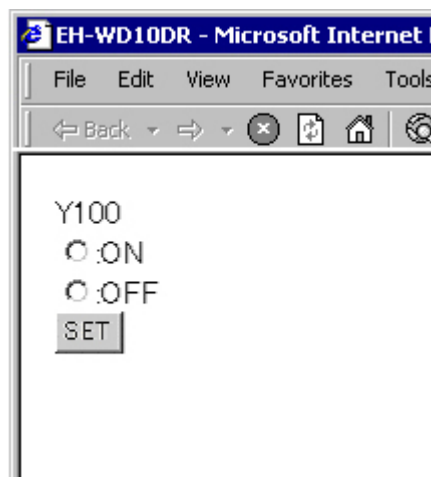

Figure 15.9 HTML tag example (6) for data memory setting

- HTML file to set a value by selecting it from a list box  
A list box can be used to set a value to “Y100” by selecting it from the list box.  
Using this HTML file, “1” can be set to “Y100” by selecting “ON” and click [SET]. Using this HTML file, “0” can be set to “Y100” by selecting “OFF” and click [SET].

HTML statement example

```
<HTML>
<HEAD>
  <TITLE>Set 7</TITLE>
</HEAD>

<BODY>
  <FORM METHOD=post ACTION=../browse.cgi>
    <%IO IOPASS 0 %>
    <INPUT TYPE=hidden NAME=IO_1 VALUE="Y 100">
    Y100<BR>
    <SELECT NAME=IOV_1>
    <OPTION VALUE="1">ON
    <OPTION VALUE="0">OFF
    </SELECT>
    <INPUT TYPE=submit VALUE=SET>
  </FORM>
</BODY>
</HTML>
```

Web browser display

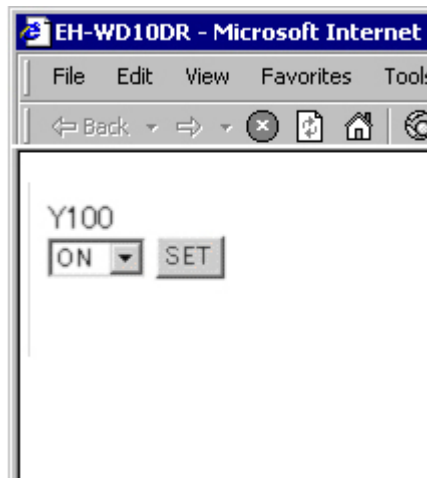

Figure 15.10 HTML tag example (7) for data memory setting

# Chapter 16 List of Specifications

## 16.1 General Specifications

Table 16.1 General Specifications

Item	Specifications	
Web Controller	10 points type	23 points type
Type	EH-WD10DR	EH-WA23DR
Power supply type	DC	AC
Power voltage	24 V DC	100 / 110 / 120 V AC (50 / 60 Hz) 200 / 220 / 240 V AC (50 / 60 Hz)
Current Consumption	150 mA	Routine 0.4A, Rush 15A (100 V AC)      Routine 0.2A, Rush 40A (264 V AC)
Power voltage fluctuation range	19.2 to 26.4 V DC	85 to 264 V AC Wide range
Allowable momentary power failure	19.2 to 26.4 V DC: Operation is not interrupted by a momentary power failure of less than 1ms.	85 to 100 V AC: Operation is not interrupted by a momentary power failure of less than 10ms. 100 to 264 C AC: Operation is not interrupted by a momentary power failure of less than 20ms.
Operating ambient temp.	0 to 55 centigrade (Storage ambient temp. -10 to 75 centigrade)	
Operating ambient humidity	5 to 95% RH (no condensation) (Storage ambient humidity 5 to 95% RH (no condensation))	
Vibration proof	Conforms to JIS C0911	
Noise resistance	- Noise voltage 500Vpp Noise pulse width 100ns, 1μs. (Noise created by the noise simulator is applied across the power supply module's input terminal. This is determined by our measuring method.) - Static noise: 3,000V at metal exposed area - Conforms with IEC61131-2 (2003)	- Noise voltage 1,500Vpp Noise pulse width 100ns, 1μs. (Noise created by the noise simulator is applied across the power supply module's input terminal. This is determined by our measuring method.) - Based on NEMA ICS 3-304. - Static noise: 3,000V at metal exposed area - Conforms with IEC61131-2 (2003)
Supported standards	Conforms with CE markings and C-TICK	
Insulation resistance	20M Ω or more between the DC power supply external terminal and the protection earth (PE) terminal (based on 500V DC mega)	20M Ω or more between the AC external terminal and the protection earth (PE) terminal (based on 500V DC mega)
Withstand voltage	500V DC for one minute between the DC power supply external terminal and the protection earth (PE) terminal	1,500V AC for one minute between the AC external terminal and the protection earth (PE) terminal
Grounding	Class D dedicated grounding	
Environment used	No corrosive gases and no excessive dirt	
Structure	Attached on an open wall	
Cooling	Natural air cooling	



## 16.2 Dimensions Diagram

(1) 10 points type

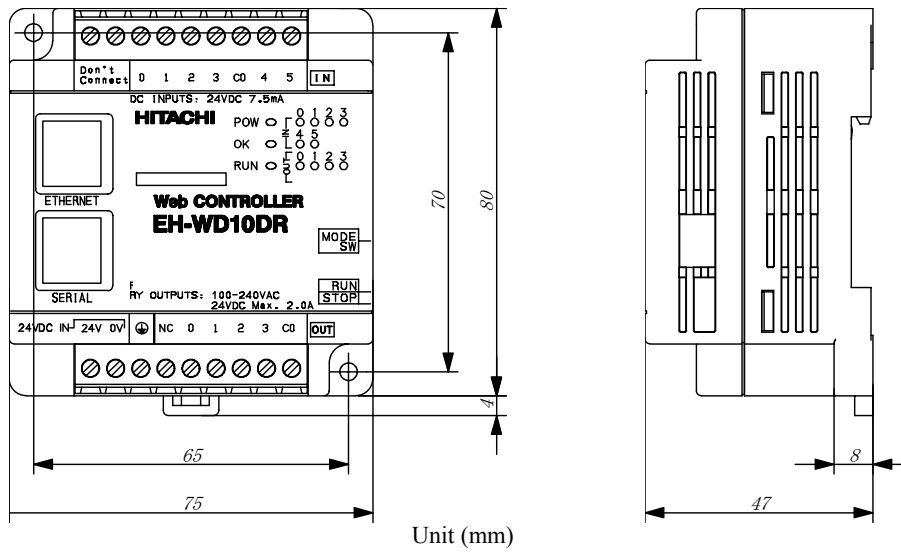

Figure 16.1 Dimensions Diagram (10 points type)

(2) 23 points type

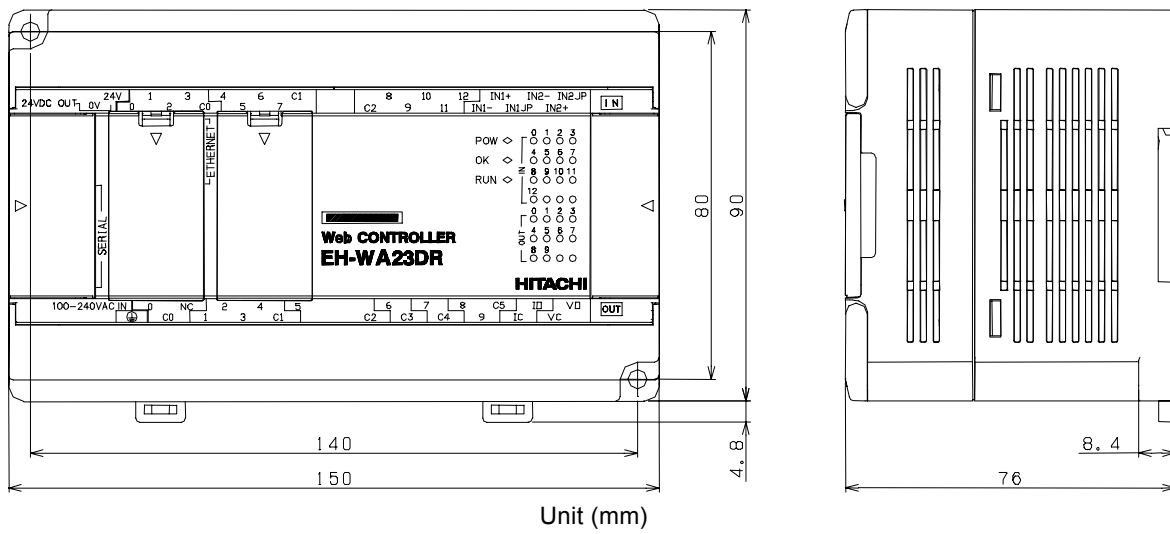

Figure 16.2 Dimensions Diagram (23 points type)

## 16.3 Function Specifications

### Web Controller dedicated functions

No.	Item	Description	
		10 points type	23 points type
	Web Controller	EH-WD10DR	EH-WA23 DR
	Type	EH-WD10DR	EH-WA23 DR
1	E-mail sending function	Web Controller is equipped with SMTP (Simple Mail Transfer Protocol) enabling e-mails to be sent to a mail server. Web Controller supports POP-before-SMTP method.	
2	Task code communication	This function can be used on Ethernet port and serial port. Users can easily retrieve data from Web Controller by connecting this unit to a touch panel or other device.	
3	Active-HIProtocol Communication (Serial port)	By connecting the serial port of Web Controller to the dedicated port of the HITACHI H/EH series PLC with a cross cable for serial communication, it is possible to retrieve internal output data from HITACHI H-EH series PLC or to store the data in Web Controller in HITACHI H/EH series PLC.	
4	General purpose configurable communication (Serial port)	By using dedicated instructions (TRNS 0/RECV 0), users can exchange data between Web Controller and a device with serial communication interface.	
5	Message communication (Ethernet port)	Web Controller has the "Event Send" function that is triggered by a change in internal data and the "Cyclic Send" function that sends out data cyclically at specified intervals.	
6	Web service	Users can register any HTML file in Web Controller. With the HTML tags dedicated to Web Controller, data in Web Controller can be displayed (read out) on a Web browser and can be set (written in) on the unit.	
7	Time retrieval function	This function retrieves calendar and time from NTP and SNTP servers on the network and can be managed by synchronizing Web Controller to the calendar and time.	This function retrieves calendar and time from NTP and SNTP servers on the network and can be managed by synchronizing Web Controller to the calendar and time. Also, Web Controller can use the calendar and time information independently by using RTC and the battery (optional) built in Web Controller.
8	System configuration function	Users can customize various parameters of Web Controller by using the Web-based configuration tool. Customization authorization can be set to prevent incautious customization by general users.	Users can customize various parameters of Web Controller by using the Web-based configuration tool. Customization authorization can be set to prevent incautious customization by general users. Web Controller can save customized parameters as text files.

## Controller Function

No.	Item		Description	
	Web Controller		10 points type	23 points type
	Type		EH-WD10DR	EH-WA23DR
1	Basic functions		Operations are performed according to the contents of user programs.	
2	Setting and display		The setting and display functions are equipped for users to set or confirm various types of operation status.	
3	Number of I/O points		<p>1] External input/output: The number of points is 6 points for external input, and 4 points for external output.</p> <p>2] Internal output: These areas are used for storing information temporarily. The I/O numbers includes M, WM, DM, R, WR, and DR.</p> <p>3] An area to store the timer counter elapsed value is provided internally.</p> <p>4] Array (corresponding to assignment statements only): An array of I/O numbers can be expressed by enclosing with parentheses.</p>	<p>1] External input/output: The number of points is 13 points for DC input, and 10 points for relay output.</p> <p>Two channels for analog input, and one channel for analog output.</p> <p>It is possible to increase the number of points for input/output by using extension units for MICRO-EH series.</p> <p>2] Internal output: These area are used for storing information temporarily. The type of internal output includes M, WM, DM, R, WR and DR.</p> <p>3] An area to store the timer counter elapsed value is provided internally.</p> <p>4] Array (corresponding to assignment statements only): Array of I/O numbers can be expressed by enclosing with parentheses.</p>
4	User program memory		A program containing descriptions of controls is referred to as a user program. Web Controller has work memory to execute user programs and Flash ROM to store them.	
5	Control method		Web Controller runs a batch conversion of user programs at start-up, and sequentially reads out the converted programs for serial execution.	
6	Run/stop control		Run/stop operation of Web Controller is normally performed by users.	
7	Operation parameters		Users can perform various settings for operation of Web Controller. Users can also set operations when abnormalities are detected.	
8	Change in RUN status		A part of a program can be modified during operation.	
9	Forced set/reset		Forced set and forced reset of the specified I/O can be performed from the programming unit connected to Web Controller.	
10	Forced output		Forced output can be performed to the specified I/O number from the programming unit connected to Web Controller and Web pages described by the extension HTML tag. Outputs are shut off for the I/O that is not specified.	
11	Digital filter		Digital filter functions can be set to the input.	
12	Dedicated port		This is a communication port with dedicated protocol for the HITACHI H/EH series PLC.	
13	Self-diagnosis		The self-diagnosis function constantly monitors the status of Web controller and stores diagnosis results in a dedicated area (WRF000).	
14	Handling of abnormalities		When a problem occurs, an error code that indicates the error description is stored in special internal output.	
15	Instruction		Programming can be performed for various purposes and usages by combining Ladder and instruction word.	

## 16.4 Ethernet Port Specifications

### (1) Basic specifications

Item	Specifications	
Web Controller	10 points type	23 points type
Type	EH-WD10DR	EH-WA23DR
Ethernet specifications	Compatible with IEEE802.3, 10 BASE-T	Compatible with IEEE802.3, 10 BASE-T/100 BASE-TX (automatic recognition)
Communication modulation type	Baseband	
Media access type	CSMA/CD	
Protocol	TCP/IP, UDP/IP, ICMP, ARP	
Maximum segment length	100 (m)	
Type of module-side socket	RJ-45 (8 pins)	
Connection cable	Category 5 UTP or STP cable	

### (2) Message communication specifications

Item	Specifications	
Web Controller	10 points type	23 points type
Type	EH-WD10DR	EH-WA23 DR
Communication protocol	Configured by user	
Connections	6	
TCP/IP Connection type	TCP/IP-Active Specified TCP/IP-Passive Specified TCP/IP-Passive Optional	
Datagram connection type	UDP/IP-Send Specified UDP/IP-Send Broadcast UDP/IP-Receive Specified UDP/IP-Receive Optional	
Send type	Event send : Trigger bit (R0 to R7BF) Cyclic send : Configured in 1 second increments (1 to 65,535)	
Receive type	Automatic reception in dedicated area	
Maximum message length	730 words (1460 bytes)	
Send/receive area	Send: WR0 - 3FFF, WM0 - 3FF, WX* and following consecutive areas Receive: WR0 - 3FFF, WM0 - 3FF, WY* and following consecutive areas	
Status register	The statuses of message communication is stored in the specified external output area. 1] Receiving counter 2] Transmitting counter 3] Close flag 4] Receiving buffer overflow flag 5] Open flag	
Control Register	Reopen Request Bit	(Configured among R0 to R7BF)
	Retry count	(Configured among 0 to 999 times)
	Retry interval	(Configured among 0 to 999 seconds)

(3) Task code communication specifications

Item	Specifications	
Web Controller	10 points type	23 points type
Type	EH-WD10DR	EH-WA23DR
Communication protocol	Dedicated procedure with task code commands	
Connections	4 (Simultaneously usable)	
TCP/IP Connection type	Passive Optional	
Timeout monitoring	1 to 65,535 seconds	

(4) Time data specifications

Item	Specifications	
Web Controller	10 points type	23 points type
Type	EH-WD10DR	EH-WA23DR
Communication protocol	SNTP	
Retrieval Interval	Set by user (0hr/1min to 99hr/99min)	
Retrieved Time Data	Year/month/day of the week/hour/minute/second (support time zone)	
Where the time data is stored	Special internal output area (WRF01B - WRF01F)	

## 16.5 Web Communication Specifications

Item	Category	Specification	
Web Controller		10 points type	23 points type
Type		EH-WD10DR	EH-WA23 DR
Web server	HTTP Version	1.0	
	Web screen	Super User Registration screen (system installed) System Configuration screen (system installed) Screens prepared by users	
Web page registration	Types of files to be registered	Files with extensions '.htm', '.gif' or '.jpg'	Files with extensions '.html', '.htm', '.gif', '.jpg', '.jpeg', '.bmp', '.css', '.js', '.wav', '.clase' or '.swf'
	The number of files to be registered	Maximum 40 files (No.1 to 40)	The number of files to be registered: Variable
	File size	No.1 to 8: 16k byte, No.9 to 24: 8k byte, No.25 to 40: 4k byte	Total file size: 320k bytes (64k bytes x 5 sectors)
	Preparation	With HTML tags and dedicated tags, by dedicated CGI access	
Web Browsing	Recommended browser	Microsoft Internet Explorer version 6 or later	
	Screens installed in system	(1) Super User Registration screen Maximum 4 Super Users (16 one-byte characters), password 16 characters	
		(2) System Configuration screen 1] HTML registration 2] IP address 3] E-mail setting 4] Ethernet protocol setting 5] Serial port setting 6] ID/password 7] Password for e-mail setting 8] Password for I/O set	(2) System Configuration screen 1] HTML registration 2] IP address, DNS server, NTP server setting. 3] E-mail setting 4] Ethernet protocol setting 5] Serial port setting 6] ID/Password setting 7] Password for e-mail setting 8] Password for I/O set 9] Analog I/O setting 10] SNMP community name setting 11] Upload/Download of Configuration files
		(3) Mail settings Conforms to CTML. Input address for each specified subject.	
	User authentication	Access control by ID/Password for each HTML file	
	Encryption	None	
	Number of IDs registered	16 (ID: 16 one-byte characters, password: 6 one-byte characters)	
	I/O Monitor	Monitoring can be operated from a Web browser based on the HTML files with dedicated tags. 1] Monitor I/O External I/O: X/Y/WX/WY, Internal output: R/M and others, WR/DR/WM/DM 2] Display format Binary/decimal/hexadecimal display can be set. Replacing to character strings according to I/O values is possible. (Characters to replace values: 32 one-byte characters or less)	
	I/O set	I/O can be set from a Web browser based on the HTML files with dedicated tags. 1] Settable I/O External output: Y/WY, Internal output: R/M and others, WR/DR/WM/DM 2] Using the user authentication function can prevent data manipulation by a third person.	
	Comment	Referencing and registration can be performed from a Web browser based on the HTML files with dedicated tags. 1] The number of comment tags: 256 2] Character of comments: 128 double-byte characters (256 one-byte characters) 3] Transferable to internal output WR by Ladder command instruction	

## 16.6 E-mail Specifications

Item	Specifications	
Web Controller	10 points type	23 points type
Type	EH-WD10DR	EH-WA23DR
Mail server protocol	SMTP	
User Authentication	POP-before-SMTP (account: 1 to 64 one-byte characters, password: 1 to 64 one-byte characters)	
Encryption	None	
Server configuration	Compatible with DNS.	
	SMTP server: Up to 64 one byte characters.	
	POP server: Up to 64 one byte characters.	
Registration of E-mail address	One address up to 56 one byte characters.	
Triggers	16 triggers (Settable from R0 - 7FF)	
Number of Registerable Addresses	Up to 8 per trigger: up to 56 one byte characters.	
Subject	Up to 32 double-byte characters (64 one byte characters).	
Body	Up to 128 double-byte characters (256 one byte characters).	
Data	3 words (selected from WR0 - 3FF, F000 - 1A9F, comment: up to 16 one byte characters).	

## 16.7 Serial Port Specifications

### (1) Basic specifications

Item	Specifications		
Web Controller	10 points type	23 points type	
Type	EH-WD10DR	EH-WA23DR	
Communication system	Half duplex		
Synchronization	Asynchronous		
Transmission system	Serial transmission (bit serial transmission)		
Transmission code outgoing sequence	Sent out from the lowest bit in character units		
Error control	Vertical parity check, checksum, overrun check, framing check		
Transmission unit	Message unit (variable length)		
Interface	Conforms to RS-232C	RS-232C or WS-422 / 485 (Specifies on the Configuration page.)	
		RS-232C	RS-422 / 485
Transmission distance	15m (Maximum)	15m (Maximum)	500m (Maximum)
Transmission form	1 : 1	1 : 1	1 : N (N is 31 maximum)
Type of module-side socket	RJ-45 (8 pins)		

### (2) General purpose communication specifications

Item	Specifications		
Web Controller	10 points type	23 points type	
Type	EH-WD10DR	EH-WA23DR	
Communication instruction	Dedicated communication instruction by Ladder program of the main unit (TRNS0/RECV 0)		
Communication speed	Select from 300, 600, 1200, 2400, 4800, 9600, 19.2k, 38.4k, 57.6k	Select from 300, 600, 1200, 2400, 4800, 9600, 19.2k, 38.4k, 57.6k, 115.2k	
Startup system	Transmission, reception after transmission, reception, transmission after reception		
Transmission code	ASCII/Binary (Set by user)		
Transmission format	Select from 7 patterns: 7/8 data length, 1 start, 1/2 stop, parity present/not present		
Maximum message length	1024 bytes (including control characters)		
Control procedure	Configured by user		

### (3) Active-HIProtocol specifications

Item	Specifications		
Web Controller	10 points type	23 points type	
Type	EH-WD10DR	EH-WA23DR	
Connected PLC	HITACHI Programmable Controller <ul style="list-style-type: none"> <li>• H-20/28/40/64, H-200/250/252, H-300/700/2000</li> <li>• H-302/702/1002/2002/4010, EH-150, MICRO-EH</li> </ul>		
Communication area of connected PLC	WR/WM/WL		
Data transfer mode	Monitor Monitor & I/O Set/Reset Trigger (Trigger: specify R0 – R7BF) Data link (monitor and set)		
Data transfer size	Read: 120 words; Write: 100 words		
Communication speed	Automatic detection of communication speed of connected PLC		
Startup system	One-sided startup using the host side command, LUMP address settable		
Transmission code	ASCII		
Transmission code configuration	7-bit data, 1 start, 1 stop, even parity		
Maximum message length	503 bytes (including control characters)		
Control procedure	H-series dedicated procedure (HIProtocol) Standard protocol (transmission control procedure 1), Simplified protocol (transmission control procedure 2)		



## (4) Passive-HIProtocol specifications

Item		Specifications	
Web Controller		10 points type	23 points type
Type		EH-WD10DR	EH-WA23DR
Communication speed	Without modem	Select from 4,800, 9,600, 19.2k, 38.4k	
	Using modem	Select from 2,400, 4,800, 9,600, 19.2k, 38.4k, 57.6k	
Startup system		One-sided startup using the host side command	
Transmission code		ASCII	
Transmission code configuration		7-bit data, 1 start, 1 stop, even parity	
Maximum message length		503 bytes (including control characters)	
Control procedure		H-series dedicated procedure (HIProtocol) Standard protocol (transmission control procedure 1), Simplified protocol (transmission control procedure 2)	

## 16.8 Calculation Specifications

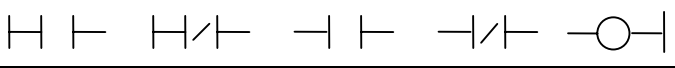
Web Controller		10 points type	23 points type		
Type		EH-WD10Dr	EH-WA23DR		
Control Specifications	CPU	32-bit RISC processor			
	Processing system	Stored program cyclic system			
	Processing speed	Basic instructions	Several $\mu$ s/instruction		
		Application instructions	Several tens $\mu$ s/instruction		
User program memory		3,455 steps (Automatic backup in Flash ROM)	7,551 steps (Automatic backup in Flash ROM)		
Operation processing specifications	Instruction word	Basic instructions	35 types including LD, LDI, AND, ANI, OR, ORI, ANB, ORB, OUT, MPS, MRD, MPP		
		Arithmetic instructions Application instructions	91 types (arithmetic, application, control, FUN, command, etc.)		
	Ladder	Basic instructions	35 types such as 		
		Arithmetic instructions Application instructions	91 types (arithmetic, application, control, FUN, command, etc.)		
I/O processing specifications	External I/O	I/O processing system	Refresh processing		
		Number of I/O points	Digital: Input 6 points X000 to X005 / output 4 points Y100 to Y103	Digital: Input 13 points X000 to X012 / Output 10 points Y100 to Y109	
				Analog: Input 2 channels WX30 to WX31 / Output 1 channel WY40	
	Using extension units		Digital: Input 77 points / Output 58 points (Using 4 extension units of 28 points type)		
			Analog: Input 18 channels / Output 9 channels (Using 4 analog extension units)		
	Internal output	Bit	1,984 points (R0 to R7BF)		
			Word	16,384 words (WR0 to WR3FFF)	50,176 words (WR0 to WR3CFF)
		Special		Bit	64 points (R7C0 to R7FF)
			Word	416 words (WRF000 to WRF1FF)	512 words (WRF000 to WRF1FF)
		Bit/Word shared	16,384 points, 1,024 words (M0 to M3FFF, WM0 to WM3FF)		
		Comment	128 points (for reference/registration from Web browser)		
	Timer counter	Number of points	256 points (TD + CU)*1		
		Timer set value	0 to 65,535, timer base 0.01 s, 0.1 s, 1 s (0.01 s has maximum 64 points *2)		
Counter set value		1 to 65,535 times			
Edge detection		512 points (DIF0 to DIF511: Decimal) + 512 points (DFN0 to DFN511: Decimal)			
Peripheral equipment	Program system	Instruction word, ladder diagram			
	Peripheral unit	Programming software (LADDER EDITOR Windows <sup>(R)</sup> version)			
Maintenance functions	Self-diagnosis	PLC error (LED display): Microcomputer error, watchdog timer error, memory error, program error, system ROM/RAM error, scan time monitoring, etc.			

\*1: The same number of Timer and Counter cannot be used.

\*2: Timer which can be set 0.01s to the timer base is only No.1 to No.63.

## 16.9 I/O Specifications

(1) I/O terminal specifications and layout/wiring

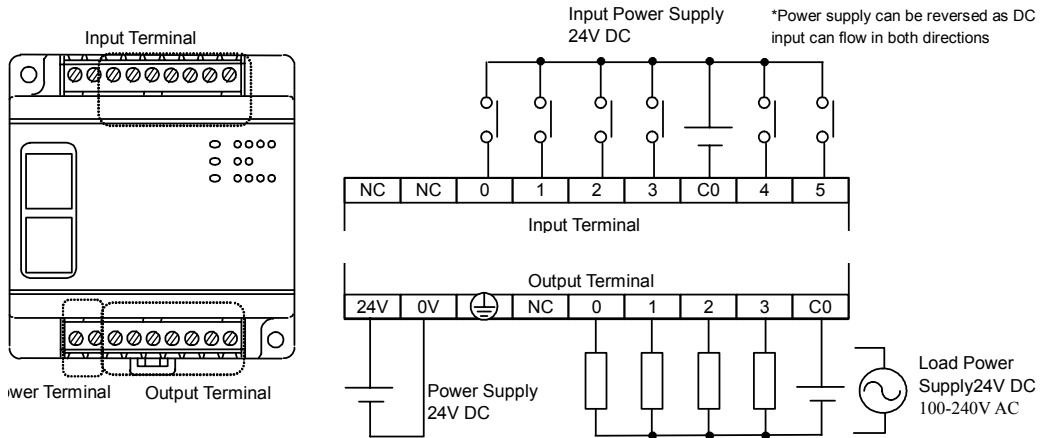

Figure 16.3 Terminals Configuration and Connection (10 points type)

Table 16.2 Input specifications

Item		Specifications	Internal circuit diagram
Input voltage		24V DC	
Allowable input voltage range		0 to 30V DC	
Input impedance		Approx. 2.8 k ohm	
Input current		7.5mA typical	
Operating voltage	ON voltage	15V DC (minimum)	
	OFF voltage	5V DC (maximum)	
Input lag	OFF → ON	0.5 to 20 ms (configurable)	
	ON → OFF	0.5 to 20 ms (configurable)	
Number of input points		6 points	
Number of common		1	
Polarity		None	
Insulation system		Photocopier insulation	
Input display		LED (green)	
External connection		Fixed type terminal block	
Insulation		500V or more (between PE terminal and external I/O)	

Table 16.3 Output specifications

Item		Specifications	Internal circuit diagram
Rated load voltage		5 to 250V AC, 5 to 30V DC	
Minimum switching current		1mA	
Maximum load current	1 circuit	2A (24V DC, 240V AC)	
	1 common	5A	
Output response time	OFF → ON	15ms (maximum)	
	ON → OFF	15ms (maximum)	
Number of output points		4 points	
Number of commons		1	
Surge removing circuit		None	
Fuse		None	
Insulation system		Relay insulation	
Output display		LED (green)	
External connection		Irremovable type terminal block	
External power supply (for driving the relay)		Not necessary	
Contact life *1		20,000,000 times (mechanical) 200,000 times (electrical: 2 A)	
Insulation		500V or more (between PE terminal and external I/O)	

(2) 23 points type

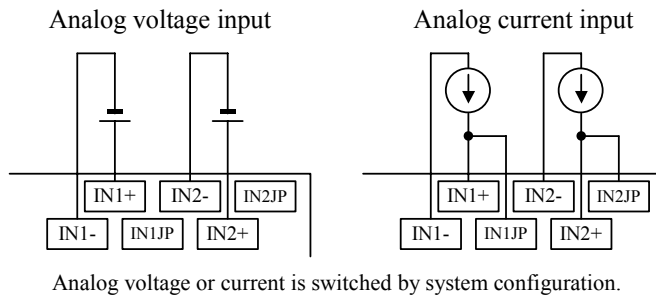
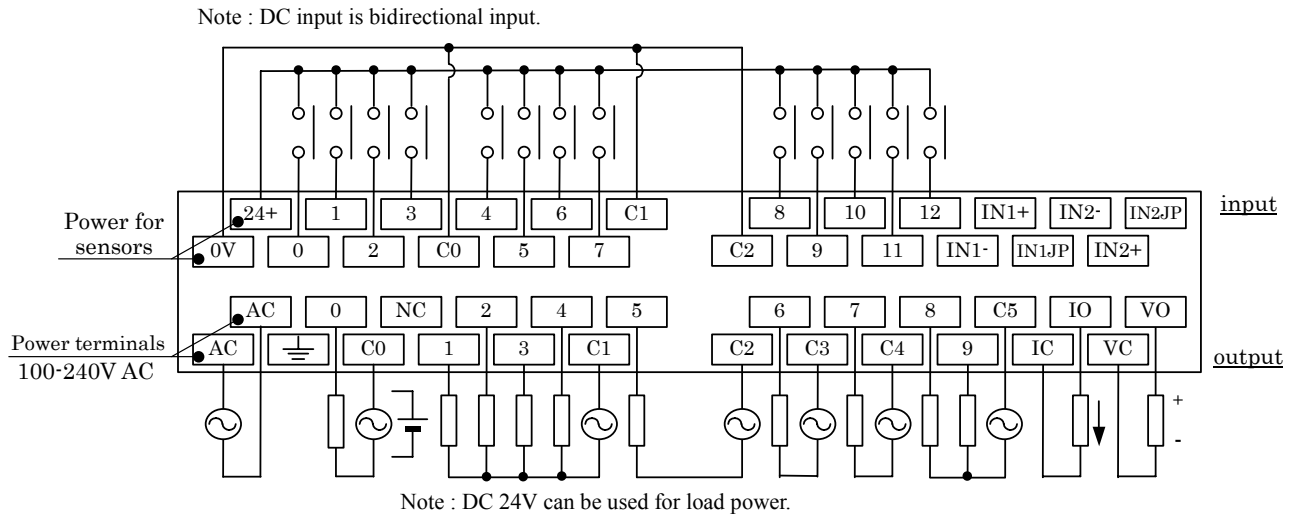

Figure 16.4 Terminals Configuration and Connection (23 points type)

**Analog signal wiring**

Since analog signals are very sensitive, wiring should be taken care as follows in order to avoid external noise.

- Be sure to use shield cable for input/output cable.
- Analog signal cables must be routed apart from different voltage cable, such as power cables, as much as possible.
- Shield should be grounded at one end in principal. But grounding in both ends or floating could be better depending on noise environment. In addition, shield connecting to minus terminal of analog signal is sometimes effective. Try to fine the best grounding if necessary.

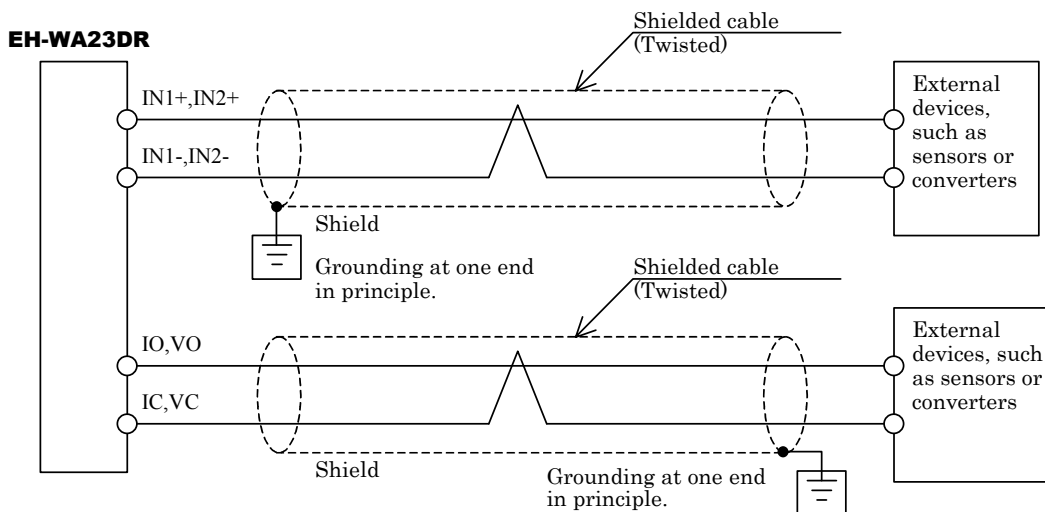

Figure 16.5 Terminal Configuration and Connection (23 points type)

**I/O Specifications**

Table 16.4 DC Input specifications

Item		Specifications	Internal circuit diagram
Input voltage		24V DC	
Allowance input voltage range		0 to 30V DC	
Input impedance		Approx. 2.8 kΩ	
Input current		7.5mA typical	
Operating voltage	ON voltage	15VDC (minimum) / 4.5mA (maximum)	
	OFF voltage	5VDC (maximum) / 1.5mA (maximum)	
Input lag	OFF → ON	Basic unit 0.5 to 20 ms (configurable) Extension unit 0.5ms or less	
	ON → OFF	Basic unit 0.5 to 20ms (configurable) Extension unit 0.5ms or less	
Number of input points		13 points	
Number of commons*		3	
Polarity		None	
Insulation system		Photocopler insulation	
Input display		LED (green)	
External connection		Removable type screw terminal block (M3)	

\*: Common terminals are not connected internally.

Table 16.5 Relay output specifications

Item		Specifications	Internal circuit diagram
Rated load voltage		5 to 250V AC, 5 to 30V DC	
Minimum switching current		1mA	
Maximum load current	1 circuit	2A (24V DC, 240V AC)	
	1 common	5A	
Output response time	OFF → ON	15ms (maximum)	
	ON → OFF	15ms (maximum)	
Number of output points		10 points	
Number of commons		6	
Surge removing circuit		None	
Fuse		None	
Insulation system		Relay insulation	
Output display		LED (green)	
External connection		Removable type screw terminal block (M3)	
External power supply (for driving the relay)		Not necessary	
Contact life*		20,000,000 times (mechanical) 200,000 times (electrical: 2 A)	
Insulation		1,500V or more (between relay and logic) 500V or more (between relays)	

\*: Depending on load current.

Table 16.6 Analog input specifications

Item	Specifications	Internal circuit diagram
Input channel address	WX30, WX31	
Input range	0 to 10V (10.24V maximum) 0 to 20mA (20.48mA maximum)	
Resolution	12 bits	
Accuracy	±1% of full scale	
Linearity	Maximum +/-3 digit	
Impedance of current input	Approx. 249Ω	
Impedance of voltage input	Approx. 100 K Ω	
Input delay	20ms	
Insulation between Analog and Logic	Non insulated	
Insulation between channels	Non insulated	

### Analog input

- EH-WA23DR has two channels of analog input. Each channel can be configured as voltage or current.
- Analog input type, voltage or current, is set by system configuration page.
- B noted that wiring of voltage input is different from current input.
- Analog signal in ch.0 is converted to digital data and stored in the register WX30. Analog signal in ch.1 is in WX31 accordingly. Correlation between analog and digital is shown below.

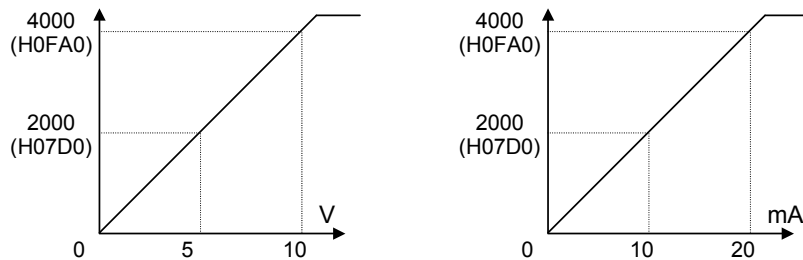

(Example) ch.0 = 3 V input → WX30 = 1200 (H04B0)  
ch.1 = 14 mA input → WX31 = 2800 (H0AF0)

- Since 0.0025 [V] or 0.005 [mA] is converted to “1”, the input range is 0 to 10.2375 [V] or 0 to 20.475 [mA].
- If signal over 10.2375 [V] or 20.475 [mA] is input, digital data will be kept as 4095 (H0FFF). If signal under 0 [V] or 0 [mA] is input, digital data will be “0”.
- Web Controller has a function of moving average, which can be used as noise filter. This function is set by system configuration page. Configure number of sampling according to the following table if necessary.

Configuration	Description	Filtering frequency
Disable	Function disable.	A/D conversion every 10ms.
Enable 2 samples	Moving average by 2 sampling values.	25Hz filter
Enable 5 samples	Moving average by 5 sampling values.	10Hz filter
Enable 10 samples	Moving average by 10 sampling values.	2.5Hz filter
Enable 16 samples	Moving average by 16 sampling values.	3.1Hz filter

\*: Factory default setting.

Table 16.7 Analog Output Specification

Item	Specification	Internal circuit diagram
Output channel address	WY40	
Output range	0-10 V (Maximum 10.24V)	
	0-20 mA (Maximum 20.48mA)	
Resolution	12 bits	
Accuracy	±1 % of full scale	
Current output		
Output impedance	10 to 500 Ω	
Capacitive load	Maximum 2,000 pF	
Inductive load	Maximum 1 H	
Voltage output		
Output impedance	Maximum 10 KΩ	
Inductive load	Maximum 1μF	
Insulation between Analog and Logic	Non insulation	
Insulation between channels	Non insulation	

### Analog Output

- EH-WA23DR has one channel of analog output.
- Since the output terminals of voltage and current are different, analog output type is switched by wiring.
- Digital data set in the register WY40 is converted to analog data and output as analog signal. Correlation between digital and analog is shown below. (Data 0 to 4000 is converted to 0 to 10 V or 0 to 20 mA signal.)

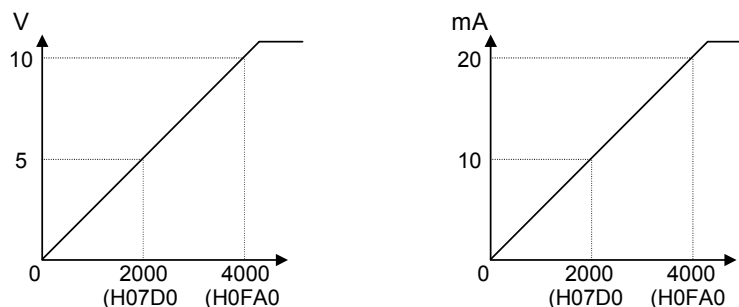

(Example) WY40 = 1520 (H05F0) → 3.8 V or 7.6 mA output depending on wiring

- Since digital value “1” is converted to 0.0025 [V] or 0.005[mA], output range is 0 to 10.2375 [V] or 0 to 20.475 [mA].
- If digital value over 4095 (H0FFF) is set in WY40, output signal will be according to mode setting as below. The mode is set by system configuration page.

Mode1: The value of the range from 4095 (H0FFF) to 65535(HFFFF) is regarded as 10.2375[V] and 20.475[mA].

(TO avoid drop down across 4095 to 4096.)

Mode2: Only lower 12 bits data are effective. This conversion way is same as MICRO-EH.

(If 4096 (H1000) is set in WY40, output signal will be “0” because effective data is only H0000.)

Factory default setting is mode 1.

## 16.10 I/O Numbers

The following table describes the usable I/O types, I/O number and number of points

Table 16.8 Usable I/O types, I/O number and the number of points

Item		Descriptions	
Web Controller		10 points type	23 points type
Type		EH-WD10DR	EH-WA23DR
External input/output points	Input	6 points (X000-005)	13 points (X000-012)
	Output	4 points (Y100-103)	10 points (Y100-109)
	At using expansions simultaneously	-	135 points
	Analog input	-	2ch.(WX30-31)
	Analog output	-	1ch.(WY40)
Internal input/output	Bit general-purpose	1,984 points (R0-R7BF)	←
	Bit special	64 points (R7C0-R7FF)	←
	16/32 bits general-purpose	16,384 words (WR0-3FFF)	50,176 words (WR0-C3FF)
	16 bits special	512 words (WRF000-WRF1FF)	←
	Bit/Word shared	16,384 points (M0-M3FFF) 1,024 words (WM0-WM3FF)	←
Edge detection	Rising	512 points (DIF0-511)	←
	Falling	512 points (DFN0-511)	←
Master Control	Set	50 points (MCS0-49)	←
	Reset	50 points (MCR0-49)	←
On-delay timer*	10ms base	64 points (TD0-63)	←
	100ms/1s base	192 points (TD64-255)	←
Single shot timer*	10ms base	64 points (SS0-63)	←
	100ms/1s base	192 points (SS64-255)	←
Up counter*		256 points (CU0-255)	←
Up-down counter*	Up	256 points (CTU0-255)	←
	Down	256 points (CTD0-255)	←
Elapsed value register	16 bits	256 points (TC0-255)	←
Elapsed value clear coil		256 points (CL0-255)	←

\*: The use of I/O number by both timer and counter is not allowed.

Example 1: When on-delay timer “TD0” is used, I/O numbers from SS1 to 255 are available for the single-shot timer.

Example 2: When on-delay timer from TD0 to 125 and up counter from CU126 to 200 are used, I/O numbers from CTU201 to 255 are available for the up-down counter (up).



# Chapter 17 Installation / Wiring

## 17.1 Installation

### (1) Installation location and environment

- (a) When installing Web Controller, use the unit under the environment within the general specifications.
- (b) Mount Web Controller onto a metal plate.
- (c) Install Web Controller in a suitable enclosure such as a cabinet that opens with a key and tool.

### (2) Installation of Web Controller

#### (a) (2) Precautions when installing Web Controller

- 1] When installing the base unit, fix it securely with screw in 2 places (M4, 20 mm in length or longer) or DIN rail.
- 2] To use Web Controller within the ambient temperature range,
  - (a) Allow ample space for air circulation. (50 mm or more at top and bottom, 10 mm or more to the left and right)
  - (b) Avoid installing Web Controller directly above the devices which generate significant heat such as heaters, transformers or large-capacity resistors.
  - (c) When the ambient temperature reaches 55 centigrade or higher, install a fan or cooler to lower the temperature to below 55 centigrade.
- 3] Avoid mounting Web Controller inside a panel where high-voltage equipment is installed.
- 4] Install Web Controller 200 mm or more away from high-voltage lines or power lines.
- 5] Avoid mounting upside down, vertical or horizontal.

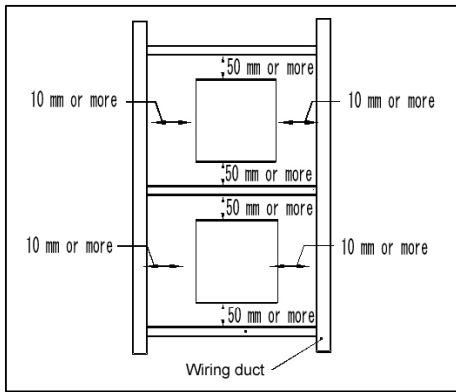
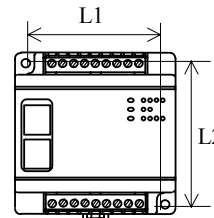
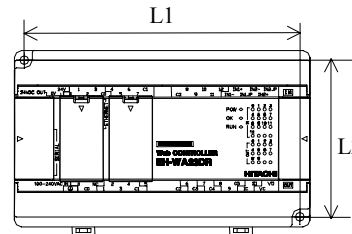

Figure 17.1 Mounting clearances



10 points type



23 points type

Figure 17.2 External dimensions

Table for dimensions

Units	L1	L2
10 points type	65	70
23 points type	140	80

Unit: mm

(b) Mounting to a DIN rail.

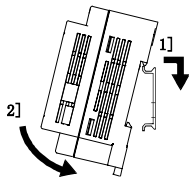

Mounting to a DIN rail

1] Hook the claw (top side) attached to the back of the unit to the DIN rail.

2] Press the unit into the DIN rail until it clicks.

Note) After the installation, please make sure if the unit is securely fixed.

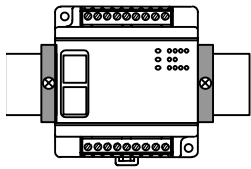

Securing on to a DIN rail.

Secure the unit with commercially available fixing brackets for securing the DIN rail to fix it from both sides. (The product may move out of place without being secured with fixing brackets.)

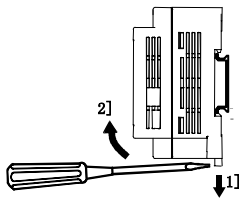

Removing from the DIN rail

Lower the DIN rail attachment mounting lever (1)) using a flat-blade screwdriver, lift the unit upward to remove (2)).

Figure 17.3 Mounting to a DIN rail

## 17.2 Wiring

### (1) Separation of the power system

The power supplies include the power for Web Controller, power for I/O signals and power for general equipment. These power supplies should be wired from separate systems to a maximum extent.

When they are supplied from one main power source, separate the wiring with a transformer or similar device to create different systems.

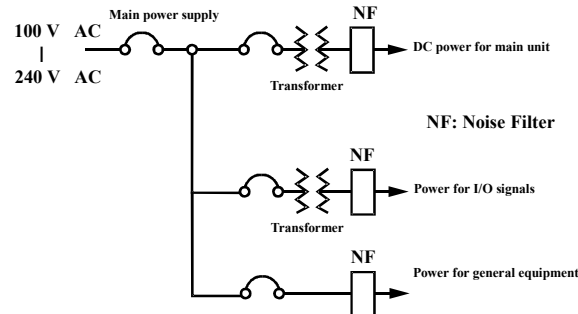

Figure 17.4 Example of power system diagram

### (2) Fail safe

#### 1] Construct an interlock circuit outside of Web Controller

When Web Controller is turned on or off, input/output may not temporarily operate normally due to the difference of the delay time or the start-up time between the power supply for Web Controller and the external power supply for I/O signals.

Therefore, turn on the power supply for the expansion unit before turning on Web Controller, or turn on the power supplies of both the expansion unit and Web Controller simultaneously. And, turn on the external power supply for I/O signals (especially DC power supply) before turning on Web Controller.

In addition, a problem in the external power supply or the malfunction of Web Controller may cause abnormal operations.

Such problems should be avoided to prevent from causing abnormal operations for the entire system, and also from the viewpoint of creating a fail-safe mechanism. For the purpose, construct circuits outside of Web Controller for the sections that may result in mechanical damage or accident if abnormal operations occur including an emergency stop circuit, protective circuit and interlock circuit.

#### 2] Install a lightning arrester.

To prevent damages to the equipment due to lightning strikes, it is recommended to install a lightning arrester for each power circuit for Web Controller.

A power failure is detected by a drop in voltage of the internal 5V DC power supply on Web Controller. On this account when a load to the internal 5V DC system on Web Controller is light, the 5V DC may be retained for a long time and an operation may be continued for 100ms or more. Therefore, when the AC input unit is used, the off-delay timer is required (to prevent misinputs) because the AC input signal is turned off faster than the internal 5V DC system.

(3) Wiring to the power supply terminal

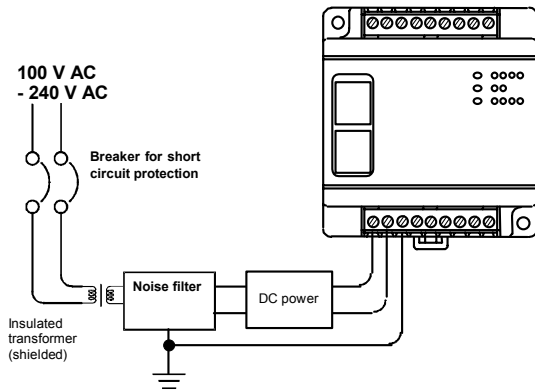

Figure 17.5 Power supply wiring diagram

- (a) To avoid a voltage drop, use a cable of 2mm<sup>2</sup> or thicker for the power supply wiring.
- (b) Use a cable of 2 mm<sup>2</sup> or thicker for the function ground terminal (PE terminal), and provide Class D grounding (100 ohms or less).

The appropriate length for the ground cable is 20m or less.

- 1] Grounding for an instrumentation panel and relay panel can be shared.
  - 2] Avoid grounding shared with the equipment which may generate noises such as high-frequency heating furnaces, large-scaled power panel (several kW or more), thyristor exchanger, electric welders, etc.
  - 3] Connect a noise filter (NF) to the power cable.
- (c) Tighten the terminal screws within the torque range shown below.

Unit	Screw	Tightening Torque
10 points type	M2.5	0.3 to 0.4 Nm
23 points type	M3.0	0.5 to 0.6 Nm

- (d) Set the power supplies of Web Controller and an expansion unit to the same systems.

(4) Wiring cable for I/O signals

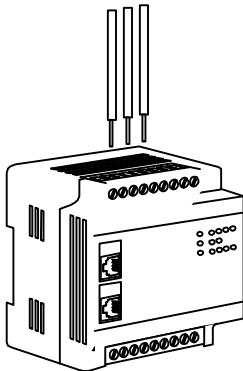

Figure 17.6 Connection diagram for cables for I/O signals (10 points type)

Tighten each terminal screw within the torque range specified above.

When a solder less terminal is used, use a cable of an external diameter 6mm or less.

Simultaneous tightening of solder less terminal is up to two sheets at the same terminal. Do not tighten more than three sheets.

Only one piece of cable can be wired per terminal if the cable type is between AWG14 and AWG22 (2.1 to 0.36 mm<sup>2</sup>) or two pieces of cable can be wired per terminal if the cable type is between AWG16 and AWG22 (1.3 to 0.36 mm<sup>2</sup>).

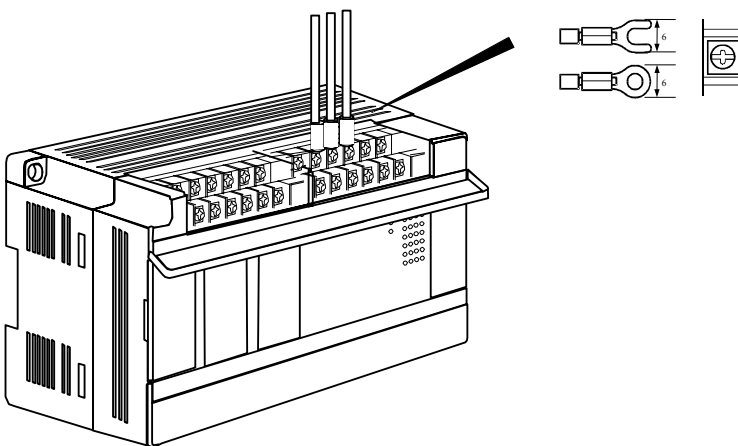

Figure 17.7 Connection diagram for cables for I/O signals (23 points type)

## (5) Wiring to the input terminals

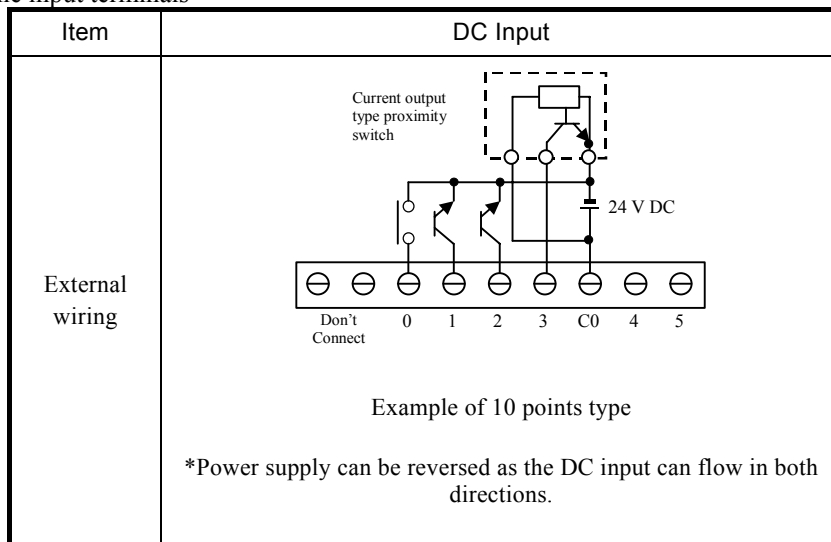
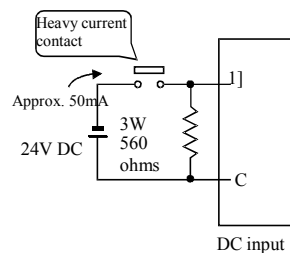

Figure 17.8 Input wiring

## (a) DC Input

- 1] When all input terminals (X000, X001...) and the common terminal (C) are loaded with 24V DC, the input becomes ON status, and approximately 7.5 mA of current flows to the external input contacts.
- 2] For sensors such as proximity switches or photoelectric switches, current output type (transistor open collector) can be connected directly. For voltage-output sensors, connect them to the input terminal after going through the transistor first.
- 3] Take measures to prevent faulty contact at heavy current contacts.



The current that flows to a contact when external contacts are closed is approximately 7.5 mA.

If heavy current contacts are used by necessity, add a resistor as shown in the figure on the left and supply sufficient current to the contact to prevent a faulty contact.

- 4] Limit the wiring length within 30 m.
- 5] Some commons in the input area do not connect internally. Connect externally if necessary.

(6) Wiring to the output terminal

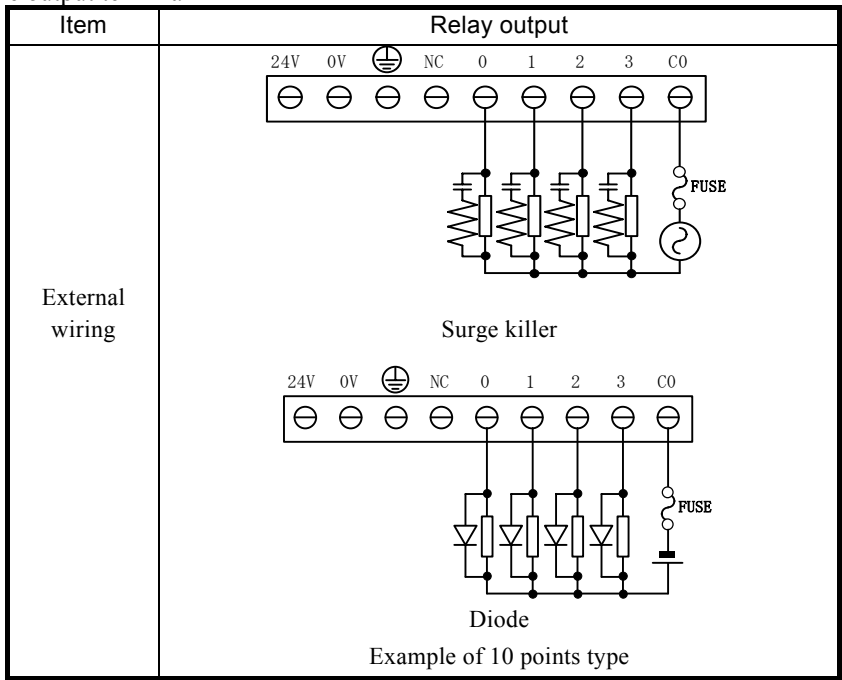
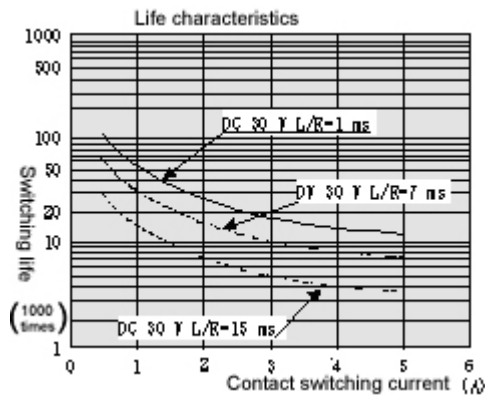
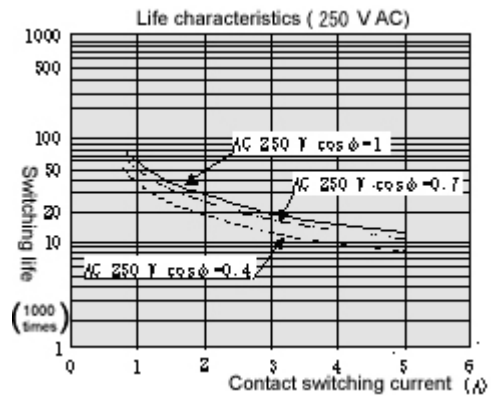
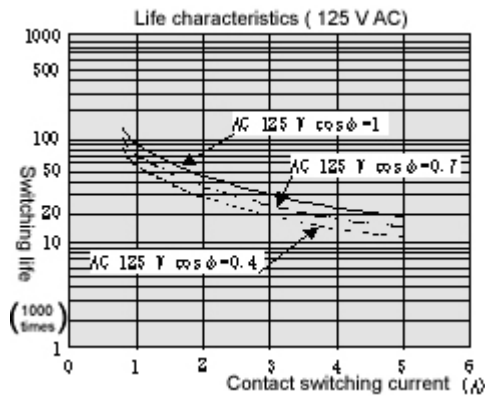

Figure 17.8 Relay output wiring

(a) Wiring to the relay output terminals

1) Life of relay contacts



Life of the contact is almost in inverse proportion to the square of the current, so be aware that interrupting rush current or directly driving the condenser load will considerably reduce the life of the relay.

② Surge killer

For inductive load, connect a surge killer (condenser 0.1 microfarad, + resistance of approximately 100 ohms) in parallel to the load. For DC load, connect a flywheel diode.

③ Fuse

Web Controller does not have a built-in fuse. Install a 6A fuse in the common to prevent the external wiring from burning out. For the independent contact output section, install a 2A fuse per circuit.

## (7) Wiring to the unit terminals

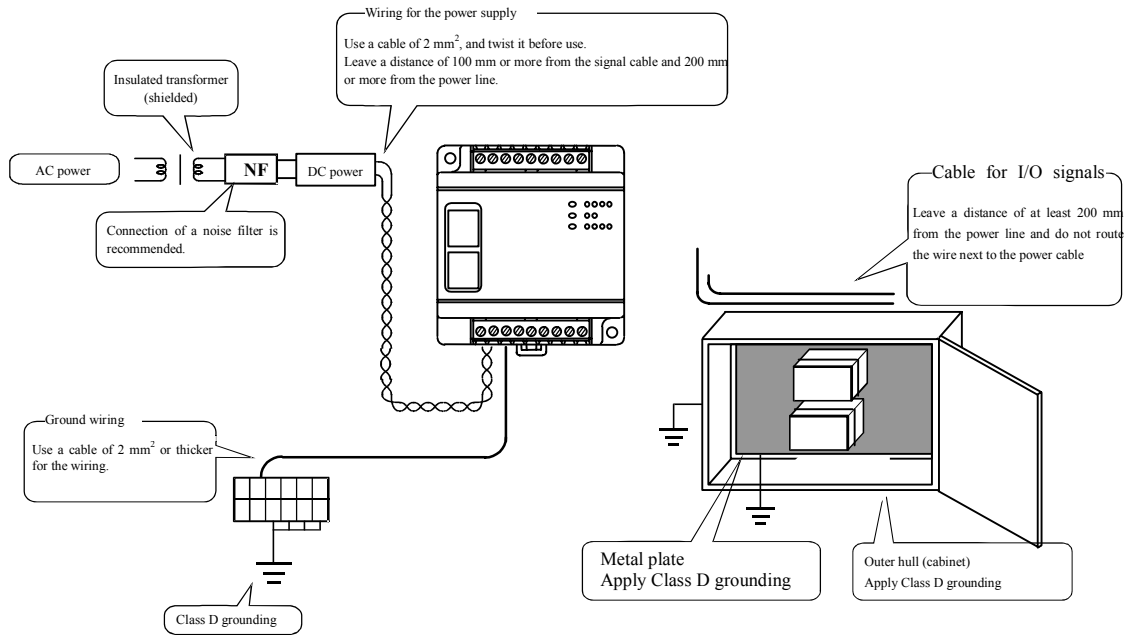

Figure 17.9 Wiring example

## (8) Wiring to the analog input/output terminals

- Be sure that the input voltage and the input current match specified voltage and current. Otherwise, there is a danger of breakdown and/or fire.
- Use for a channel which is not used in the analog input terminal, letting the internal terminal short-circuit.
- Use a shield cable for the external connection to the analog I/O terminal, and wire to routes different from other power lines of which voltage differs and signal lines. And also, connect shields to a functional ground for one side or both sides depending on applications.
- Route the AC power line and I/O lines separated as much as possible. Do not route both cable in a same duct.
- Route the I/O lines and data lines as close as possible to the grounded surfaces such as cabinet elements, metal bars and cabinet panels.

# Appendix 1 Cable Specifications

This section describes communication cables for Web Controller.

The following table shows the list of cables necessary for using the function of Web Controller.

[List of cable types]

Name of cable	Specifications of cables	Related functions	Related port
LAN cable	Category 5 (Straight/cross <sup>*1</sup> )	Web server, e-mail, task code communication	Ethernet
Cable Type I	For connection of MICRO-EH [port 1] and EH-CPU [port 2] (cross)	Active-HIProtocol General purpose	Serial (RS-232C)
Cable Type II	For connection to peripheral ports of H302/702/2002/4010 and to peripheral ports of H200/252* (cross)		
Cable Type III + WVCB-**H <sup>*2</sup>			
Cable Type IV			
Cable Type V	For connection to serial I/O of H302/702/2002/4010 (cross)		
Cable Type B I	RS-485 (2 lines type)	Active-HIProtocol General purpose	Serial (RS-422/485)
Cable Type B II	RS-422 (4 lines type)		

\*1: Select a cable according to the network environment.

\*2: EH-VCB02 and WVCB02H are the dedicated cables for the connection between H series PLC and PCs with programming software.

The following table describes the outline views of the shapes of connectors and pin number used for cables listed above.

[Shapes of connectors]

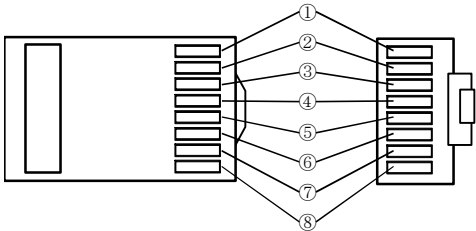
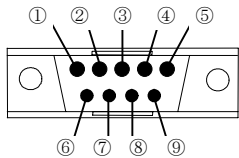
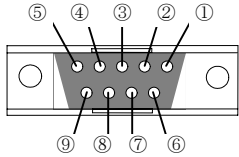
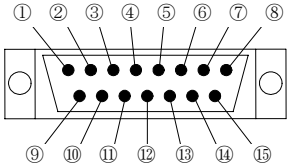
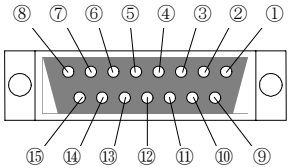
No.	Name of connector	Outline view
1	RJ-45	
2-1	D-sub 9pin (male)	
2-2	D-sub 9pin (female)	
3-1	D-sub 15pin (male)	
3-2	D-sub 15pin (female)	



The following table describes the cable schematic.

[Cable schematic]

No.	Name of cable	Cable schematic
1-1	LAN cable (straight)	
1-2	LAN cable (cross)	
2	EH-VCB02	<p>The inside of [ ] is Pin No.</p>

No.	Name of cable	Cable schematic																											
3	CB-Type I	<div style="display: flex; justify-content: space-between;"> <div style="width: 30%;"> <p>Web Controller (RJ-45)</p> <table border="1" style="width: 100%; border-collapse: collapse;"> <tr><td>[1] SG</td></tr> <tr><td>[2] CD</td></tr> <tr><td>[3] ER</td></tr> <tr><td>[4] CS</td></tr> <tr><td>[5] SD</td></tr> <tr><td>[6] RD</td></tr> <tr><td>[7] DR</td></tr> <tr><td>[8] RS</td></tr> </table> </div> <div style="width: 30%; text-align: center;"> </div> <div style="width: 30%;"> <div style="display: flex; justify-content: space-around;"> <div style="width: 45%;"> <p>EH-CPU [PORT2] (RJ-45)</p> <table border="1" style="width: 100%; border-collapse: collapse;"> <tr><td>[1] SG2</td></tr> <tr><td>[2] PV5</td></tr> <tr><td>[7] DR2</td></tr> <tr><td>[8] RS2</td></tr> <tr><td>[6] RD2</td></tr> <tr><td>[5] SD2</td></tr> <tr><td>[4] PHL/PV12</td></tr> <tr><td>[3] NV12</td></tr> </table> </div> <div style="width: 45%;"> <p>MICRO-EH [PORT1] (RJ-45)</p> <table border="1" style="width: 100%; border-collapse: collapse;"> <tr><td>[1] SG</td></tr> <tr><td>[2] VCC</td></tr> <tr><td>[7] DR1(DSR)</td></tr> <tr><td>[8] RS1(RTS)</td></tr> <tr><td>[6] RD1(RXD)</td></tr> <tr><td>[5] SD1(TXD)</td></tr> <tr><td>[4] CD1(DCD)</td></tr> <tr><td>[3] DTR1(ER)</td></tr> </table> </div> </div> </div> <p>The inside of [ ] is Pin No.</p> </div>	[1] SG	[2] CD	[3] ER	[4] CS	[5] SD	[6] RD	[7] DR	[8] RS	[1] SG2	[2] PV5	[7] DR2	[8] RS2	[6] RD2	[5] SD2	[4] PHL/PV12	[3] NV12	[1] SG	[2] VCC	[7] DR1(DSR)	[8] RS1(RTS)	[6] RD1(RXD)	[5] SD1(TXD)	[4] CD1(DCD)	[3] DTR1(ER)			
[1] SG																													
[2] CD																													
[3] ER																													
[4] CS																													
[5] SD																													
[6] RD																													
[7] DR																													
[8] RS																													
[1] SG2																													
[2] PV5																													
[7] DR2																													
[8] RS2																													
[6] RD2																													
[5] SD2																													
[4] PHL/PV12																													
[3] NV12																													
[1] SG																													
[2] VCC																													
[7] DR1(DSR)																													
[8] RS1(RTS)																													
[6] RD1(RXD)																													
[5] SD1(TXD)																													
[4] CD1(DCD)																													
[3] DTR1(ER)																													
4	CB-Type II	<div style="display: flex; justify-content: space-between;"> <div style="width: 30%;"> <p>Web Controller (RJ-45)</p> <table border="1" style="width: 100%; border-collapse: collapse;"> <tr><td>[1] SG</td></tr> <tr><td>[2] CD</td></tr> <tr><td>[3] ER</td></tr> <tr><td>[4] CS</td></tr> <tr><td>[5] SD</td></tr> <tr><td>[6] RD</td></tr> <tr><td>[7] DR</td></tr> <tr><td>[8] RS</td></tr> </table> </div> <div style="width: 30%; text-align: center;"> </div> <div style="width: 30%;"> <p>Middle size/Large size H series [PERIPHERAL] (D-sub 15pin)</p> <table border="1" style="width: 100%; border-collapse: collapse;"> <tr><td>[9][10] PG</td></tr> <tr><td>[11][12] PV5</td></tr> <tr><td>[7] DR</td></tr> <tr><td>[4] RS</td></tr> <tr><td>[3] RD</td></tr> <tr><td>[2] SD</td></tr> <tr><td>[8] PHL</td></tr> <tr><td>[5] CS</td></tr> <tr><td>[14] PV12</td></tr> <tr><td>[13] NV12</td></tr> </table> </div> </div> <p>The inside of [ ] is Pin No.</p>	[1] SG	[2] CD	[3] ER	[4] CS	[5] SD	[6] RD	[7] DR	[8] RS	[9][10] PG	[11][12] PV5	[7] DR	[4] RS	[3] RD	[2] SD	[8] PHL	[5] CS	[14] PV12	[13] NV12									
[1] SG																													
[2] CD																													
[3] ER																													
[4] CS																													
[5] SD																													
[6] RD																													
[7] DR																													
[8] RS																													
[9][10] PG																													
[11][12] PV5																													
[7] DR																													
[4] RS																													
[3] RD																													
[2] SD																													
[8] PHL																													
[5] CS																													
[14] PV12																													
[13] NV12																													
5	CB-TypeIII+ WVCB02H	<div style="display: flex; justify-content: space-between;"> <div style="width: 30%;"> <p>Web Controller (RJ-45)</p> <table border="1" style="width: 100%; border-collapse: collapse;"> <tr><td>[1] SG</td></tr> <tr><td>[2] CD</td></tr> <tr><td>[3] ER</td></tr> <tr><td>[4] CS</td></tr> <tr><td>[5] SD</td></tr> <tr><td>[6] RD</td></tr> <tr><td>[7] DR</td></tr> <tr><td>[8] RS</td></tr> </table> </div> <div style="width: 30%; text-align: center;"> </div> <div style="width: 30%;"> <div style="display: flex; justify-content: space-around;"> <div style="width: 45%;"> <p>(D-sub 9pin) (D-sub 9pin)</p> <table border="1" style="width: 100%; border-collapse: collapse;"> <tr><td>[5] SG</td></tr> <tr><td>[1] DCD</td></tr> <tr><td>[4] DTR</td></tr> <tr><td>[8] CTS</td></tr> <tr><td>[3] TXD</td></tr> <tr><td>[2] RXD</td></tr> <tr><td>[6] DSR</td></tr> <tr><td>[7] RTS</td></tr> <tr><td>[9] RI</td></tr> </table> </div> <div style="width: 45%;"> <p>Middle size/Large size H series [PERIPHERAL] (D-sub 15pin)</p> <table border="1" style="width: 100%; border-collapse: collapse;"> <tr><td>[9][10] PG</td></tr> <tr><td>[11][12] PV5</td></tr> <tr><td>[7] DR</td></tr> <tr><td>[4] RS</td></tr> <tr><td>[3] RD</td></tr> <tr><td>[2] SD</td></tr> <tr><td>[8] PHL</td></tr> <tr><td>[5] CS</td></tr> <tr><td>[14] PV12</td></tr> <tr><td>[13] NV12</td></tr> </table> </div> </div> </div> <p>The inside of [ ] is Pin No.</p> <div style="display: flex; justify-content: space-around; margin-top: 10px;"> <span>CB-TypeIII</span> <span>WVCB02H</span> </div> </div>	[1] SG	[2] CD	[3] ER	[4] CS	[5] SD	[6] RD	[7] DR	[8] RS	[5] SG	[1] DCD	[4] DTR	[8] CTS	[3] TXD	[2] RXD	[6] DSR	[7] RTS	[9] RI	[9][10] PG	[11][12] PV5	[7] DR	[4] RS	[3] RD	[2] SD	[8] PHL	[5] CS	[14] PV12	[13] NV12
[1] SG																													
[2] CD																													
[3] ER																													
[4] CS																													
[5] SD																													
[6] RD																													
[7] DR																													
[8] RS																													
[5] SG																													
[1] DCD																													
[4] DTR																													
[8] CTS																													
[3] TXD																													
[2] RXD																													
[6] DSR																													
[7] RTS																													
[9] RI																													
[9][10] PG																													
[11][12] PV5																													
[7] DR																													
[4] RS																													
[3] RD																													
[2] SD																													
[8] PHL																													
[5] CS																													
[14] PV12																													
[13] NV12																													

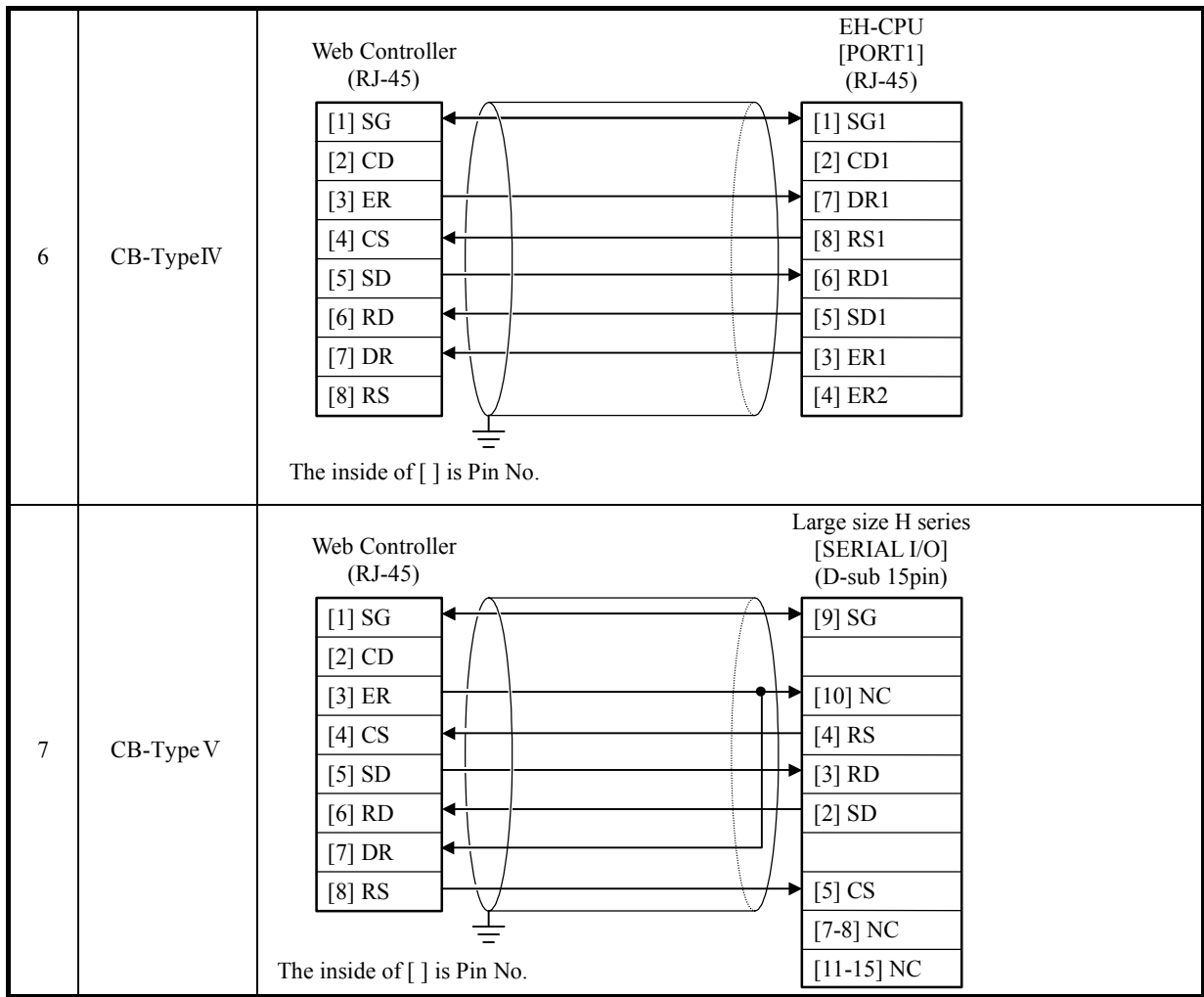

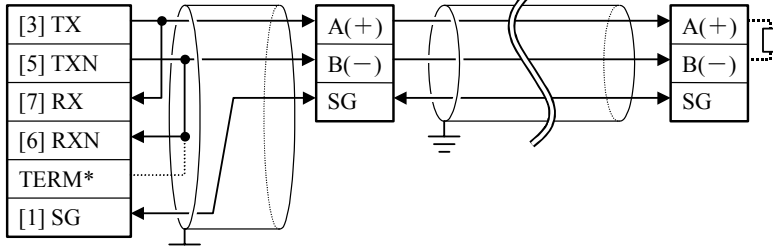
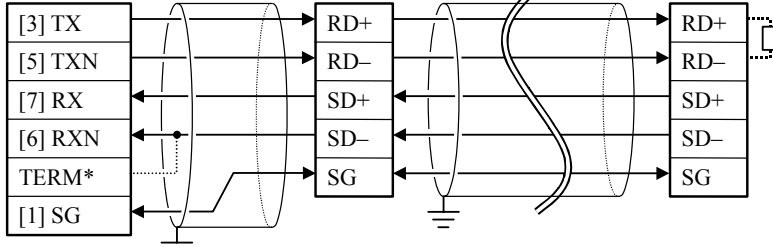
No.	Name of cable	Cable schematic
8	CB-TypeB I	<p>Web Controller (RJ-45)      External device 1      External device n</p>  <p>Termination resistance 100 Ω (1/2W)</p> <p>The inside of [ ] is Pin No.</p> <p>*: If the position of DIP No.1 switch is set to ON, the function of a built-in termination resistance (100Ω) will start to operate.</p>
9	CB-TypeB II	<p>Web Controller (RJ-45)      External device 1      External device n</p>  <p>Termination resistance 100 Ω (1/2W)</p> <p>The inside of [ ] is Pin No.</p> <p>*: If the position of DIP No.1 switch is set to ON, the function of a built-in termination resistance (100Ω) will start to operate.</p>

***MEMO***

# Appendix 2 Initialization to factory setting

To initialize the setting of Web Controller, set the Operation Mode Setting Switch to “Initialization mode” (10 points type: “7”, 23 points type: only bit 4 is “ON”) in the state which removed LAN cables and serial cables from each connector, and turn on the unit. “RUN LED” lights up for a few seconds, and starts blinking. Initialization is complete when the blinking starts. Turn off the power, and set the Operation Mode Switch to “Normal mode” (10 points type: “0”, 23 points type: “all is off”) before using.

(1) 10 points type

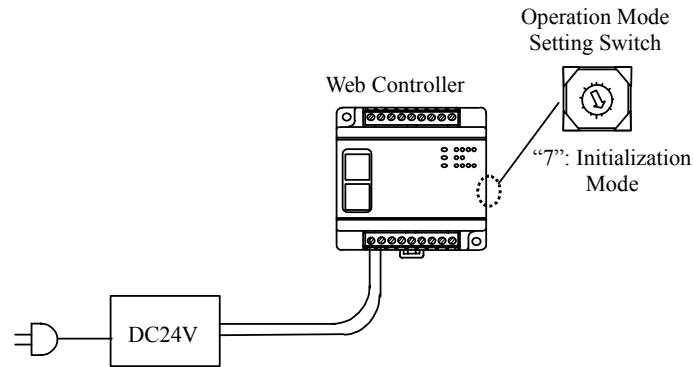

Figure Appendix 2.1 Setting Switch during Initialization Mode (10 points type)

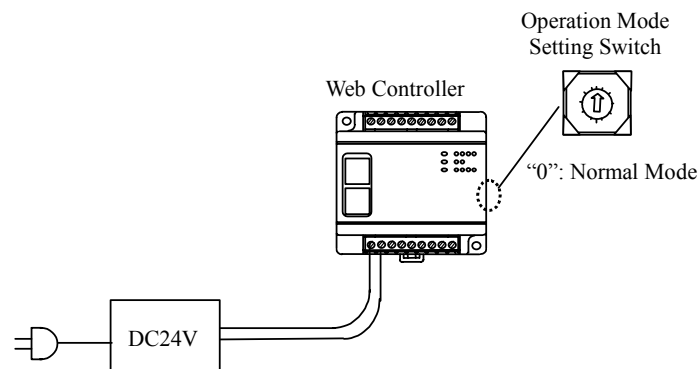

Figure Appendix 2.2 Setting Switch during the use in Normal Mode (10 points type)

(2) 23 points type

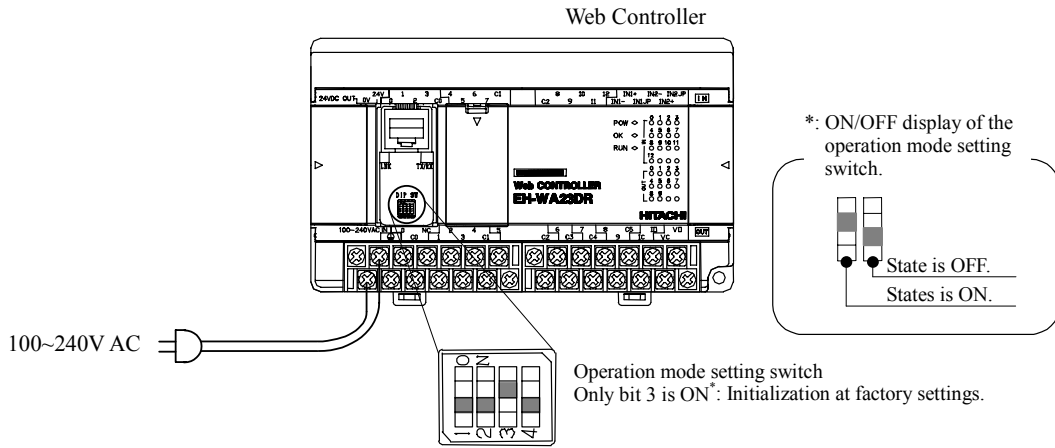

Figure Appendix 2.3 Setting Switch during Initialization Mode (23 points type)

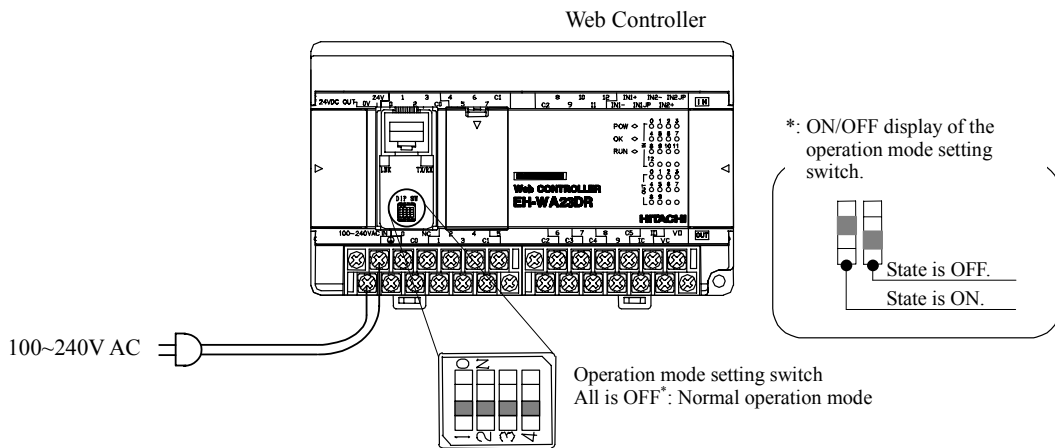

Figure Appendix 2.4 Setting Switch during the use in Normal Mode (23 points type)

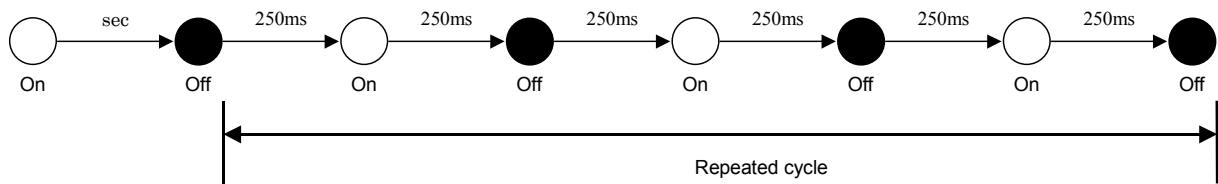

Figure Appendix 2.5 Blinking pattern of "OK LED" during Initialization Mode

**⚠ Caution!!**

Please note that all the settings of Web Controller including comment tags and ladder programs will be initialized to the factory setting after initialization. Make sure to store HTML files and ladder programs on your PC before initialization.

# Appendix 3 HTML sample files for Web pages

(1) HTML statement on I/O Monitor and I/O set on the same HTML file

HTML statement example

```
<HTML>
<HEAD>
<TITLE>example 1</TITLE>
</HEAD>

<BODY>
WM0 = <%IO WM 0 %><BR>
WM1 = <%IO WM 1 B %><BR>
WM2 = <%IO WM 2 D %><BR>
WM3 = <%IO WM 3 S %><BR>
<BR>
WR0 = <%IO WR 0 %><BR>
WR1 = <%IO WR 1 %><BR>
<BR>
WR10 = <%IO WR 10 B %><BR>
WR11 = <%IO WR 11 B %><BR>
<BR>
WR20 = <%IO WR 20 D %><BR>
WR21 = <%IO WR 21 D %><BR>
<BR>
WR30 = <%IO WR 30 S %><BR>
WR31 = <%IO WR 31 S %><BR>
<BR>

<FORM METHOD=post ACTION=../browse.cgi>
<%IO IOPASS 0 %>
<INPUT TYPE=hidden NAME=IO_1 VALUE="WM 0">
WM0 = <INPUT TYPE=text NAME=IOV_1><BR>
<INPUT TYPE=hidden NAME=IO_2 VALUE="WM 1 B">
WM1 = <INPUT TYPE=text NAME=IOV_2><BR>
<INPUT TYPE=hidden NAME=IO_3 VALUE="WM 2 D">
WM2 = <INPUT TYPE=text NAME=IOV_3><BR>
<INPUT TYPE=hidden NAME=IO_4 VALUE="WM 3 S">
WM3 = <INPUT TYPE=text NAME=IOV_4><BR>
<BR>
<INPUT TYPE=hidden NAME=IO_5 VALUE="WR 0 2">
WR0 = <INPUT TYPE=text NAME=IOV_5_1><BR>
WR1 = <INPUT TYPE=text NAME=IOV_5_2><BR>
<BR>
<INPUT TYPE=hidden NAME=IO_6 VALUE="WR 10 B 2">
WR10 = <INPUT TYPE=text NAME=IOV_6_1><BR>
WR11 = <INPUT TYPE=text NAME=IOV_6_2><BR>
<BR>
<INPUT TYPE=hidden NAME=IO_7 VALUE="WR 20 D 2">
WR20 = <INPUT TYPE=text NAME=IOV_7_1><BR>
WR21 = <INPUT TYPE=text NAME=IOV_7_2><BR>
<BR>
<INPUT TYPE=hidden NAME=IO_8 VALUE="WR 30 S 2">
WR30 = <INPUT TYPE=text NAME=IOV_8_1><BR>
WR31 = <INPUT TYPE=text NAME=IOV_8_2><BR>
<BR>
<INPUT TYPE=submit VALUE=SET>
<INPUT TYPE=reset VALUE=RESET><BR>
</FORM>

<%IO LOGOUT %><BR>
</BODY>
</HTML>
```

HTML display sample

EH-WD10DR - Microsoft Internet Explorer

File Edit View Favorites Tools Help

Back Forward Stop Home Search

WM0 = 0000  
WM1 = 0000000000000000  
WM2 = 0  
WM3 = 0

WR0 = 0000  
WR1 = 0000

WR10 = 0000000000000000  
WR11 = 0000000000000000

WR20 = 0  
WR21 = 0

WR30 = 0  
WR31 = 0

WM0 =   
WM1 =   
WM2 =   
WM3 =

WR0 =   
WR1 =

WR10 =   
WR11 =

WR20 =   
WR21 =

WR30 =   
WR31 =

SET RESET

[Logout](#)

Done



(2) I/O Set using a textbox

HTML statement example

```
<HTML>
<HEAD>
<TITLE>example 2</TITLE>
</HEAD>

<BODY>
<FORM METHOD=post ACTION=../browse.cgi>
<%IO IOPASS 0 %>
<INPUT TYPE=hidden NAME=IO_1 VALUE="M 0">
M0 = <%IO M 0 %><BR>
<INPUT TYPE=text NAME=IOV_1><BR>
<INPUT TYPE=submit VALUE=SET>
<INPUT TYPE=reset VALUE=RESET><BR>
</FORM>
<%IO LOGOUT %><BR>
</BODY>
</HTML>
```

HTML display sample

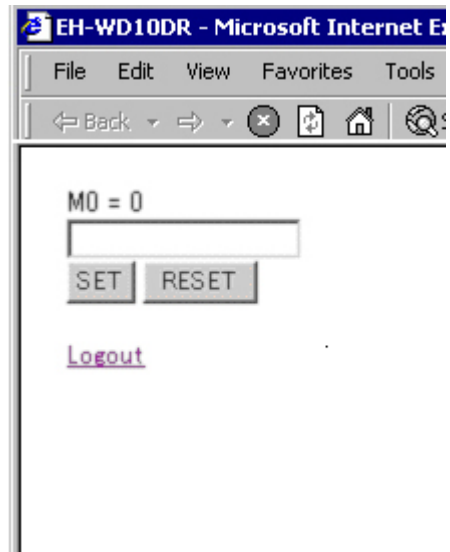

(3) I/O Set using a checkbox and a radio button

HTML statement example

```
<HTML>
<HEAD>
<TITLE>example 3</TITLE>
</HEAD>

<BODY>
<FORM METHOD=post ACTION=../browse.cgi>
<%IO IOPASS 0 %>
<INPUT TYPE=hidden NAME=IO_1 VALUE="M 1">
M1 = <%IO M 1 $ONS:$OFF$ %><BR>
ON:<INPUT TYPE=checkbox NAME=IOV_1 VALUE=1><BR>
OFF:<INPUT TYPE=checkbox NAME=IOV_1 VALUE=0><BR>
<INPUT TYPE=submit VALUE=SET><BR>
</FORM>

<FORM METHOD=post ACTION=../browse.cgi>
<%IO IOPASS 0 %>
<INPUT TYPE=hidden NAME=IO_1 VALUE="M 2">
M2 = <%IO M 2 $ONS:$OFF$ %><BR>
ON:<INPUT TYPE=radio NAME=IOV_1 VALUE=1><BR>
OFF:<INPUT TYPE=radio NAME=IOV_1 VALUE=0><BR>
<INPUT TYPE=submit VALUE=SET><BR>
</FORM>
<%IO LOGOUT %><BR>
</BODY>
</HTML>
```

HTML display sample

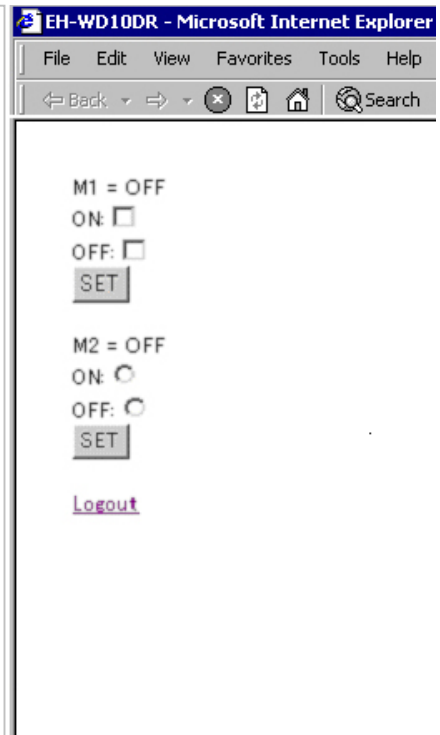

## (4) I/O Set using a checkbox and a radio button (checked with default value)

## HTML statement example

```

<HTML>
<HEAD>
  <TITLE>example 4</TITLE>
</HEAD>

<BODY>
  <FORM METHOD=post ACTION=../browse.cgi>
  <%IO IOPASS 0 %>
  <INPUT TYPE=hidden NAME=IO_1 VALUE="M 3">
  M3 = <%IO M 3 $ONS:$OFF$ %><BR>
  ON:<%IO M 3 $CHECKED$$ %><INPUT TYPE=checkbox NAME=IOV_1 VALUE=1 -IO-><BR>
  OFF:<%IO M 3 $$:$CHECKED$ %><INPUT TYPE=checkbox NAME=IOV_1 VALUE=0 -IO-><BR>
  <INPUT TYPE=submit VALUE=SET><BR>
</FORM>

  <FORM METHOD=post ACTION=../browse.cgi>
  <%IO IOPASS 0 %>
  <INPUT TYPE=hidden NAME=IO_1 VALUE="M 4">
  M4 = <%IO M 4 $ONS:$OFF$ %><BR>
  ON:<%IO M 4 $CHECKED$$ %><INPUT TYPE=radio NAME=IOV_1 VALUE=1 -IO-><BR>
  OFF:<%IO M 4 $$:$CHECKED$ %><INPUT TYPE=radio NAME=IOV_1 VALUE=0 -IO-><BR>
  <INPUT TYPE=submit VALUE=SET><BR>
</FORM>
  <%IO LOGOUT %><BR>
</BODY>
</HTML>

```

## HTML statement example

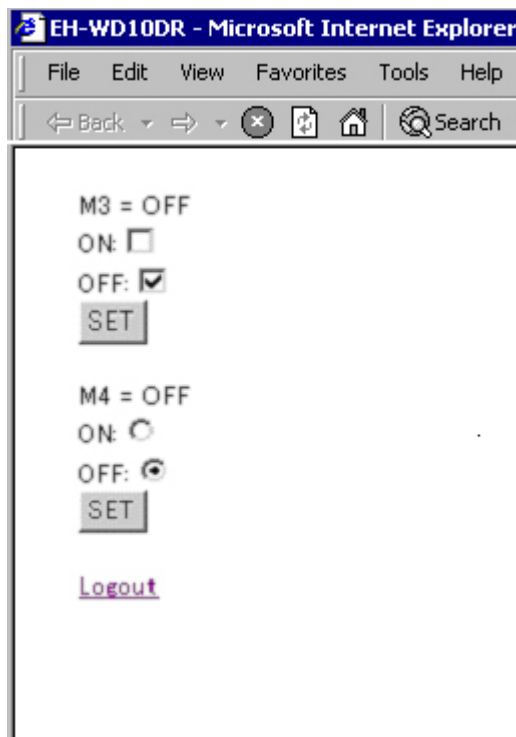

(5) To change the color of output characters depending on the value of I/O memory

HTML statement example

```
<HTML>
  <HEAD>
    <TITLE>example 5</TITLE>
  </HEAD>

  <BODY>
    M0 = <%IO M 0 %>:<%IO M 0 $BLUES:$REDS$ %><FONT COLOR=-IO-><%IO M 0 $ONS:$OFF$ %></FONT><BR>
    M1 = <%IO M 1 %>:<%IO M 1 $BLUES:$REDS$ %><FONT COLOR=-IO-><%IO M 1 $ONS:$OFF$ %></FONT><BR>
    <BR>
    <%IO LOGOUT %><BR>
  </BODY>
</HTML>
```

HTML display sample

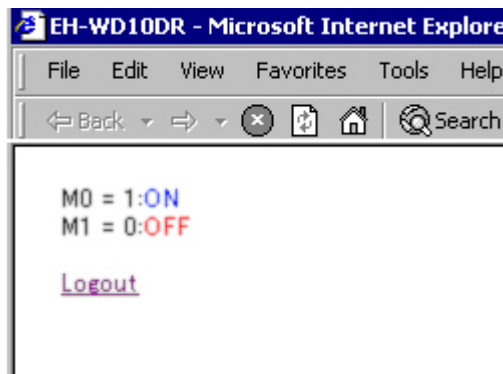

(6) Set the Time data on Web Controller using the time data on a PC (Using Java Script)

## HTML statement example

```
<HTML>
<HEAD>
  <TITLE>time</TITLE>
  <SCRIPT TYPE="text/javascript">
    <!--
      function Time() {
        now = new Date();

        year = now.getFullYear();
        month = now.getMonth() + 1;
        date = now.getDate();
        day = now.getDay();
        hours = now.getHours();
        minutes = now.getMinutes();
        seconds = now.getSeconds();

        if(date < 10)
          date = "0" + date;
        if(minutes < 10)
          minutes = "0" + minutes;

        document.TimeSet.IOV_1_1.value = year;
        document.TimeSet.IOV_1_2.value = "" + month + date;
        document.TimeSet.IOV_1_3.value = day;
        document.TimeSet.IOV_1_4.value = "" + hours + minutes;
        document.TimeSet.IOV_1_5.value = seconds;

        setTimeout("Time()",1000);
      }
    </SCRIPT>
  </HEAD>

  <BODY onLoad=Time()>
    <FORM NAME=TimeSet METHOD=post ACTION=../browse.cgi>
      <%IO IOPASS 0 %>
      <INPUT TYPE=hidden NAME=IO_1 VALUE="WR F01B 5">
      <INPUT TYPE=text NAME=IOV_1_1>:year<BR>
      <INPUT TYPE=text NAME=IOV_1_2>:month date<BR>
      <INPUT TYPE=text NAME=IOV_1_3>:day of the week<BR>
      <INPUT TYPE=text NAME=IOV_1_4>:hour minute<BR>
      <INPUT TYPE=text NAME=IOV_1_5>:second<BR>
      <INPUT TYPE=hidden NAME=IO_2 VALUE="R 7F9">
      <INPUT TYPE=hidden NAME=IOV_2 VALUE=1>
      <INPUT TYPE=submit VALUE=SET><BR>
    </FORM>
    <%IO LOGOUT %><BR>
  </BODY>
</HTML>
```

## HTML display sample

EH-WD10DR - Microsoft Internet Explorer

File Edit View Favorites Tools Help

Back Forward Stop Home Search

2004 : Year

622 : Month/Day

2 : Day of week

1157 : Hour/Minute

41 : Second

SET

[Logout](#)

### ⚠ Caution!!

**Do not specify the retrieval of the time data from NTP servers** using the above HTML sample. Because the local time data cannot be set in the setting of the special internal output if the NTP server is assigned for the time retrieval. Refer to “Chapter 11 Network Setting” for details. Refer to “Chapter 13 System Configuration” for the configuration of NTP.

***MEMO***

# Appendix 4 Sample programs for TCP/IP communication to upper hosts

Please note that sample programs listed here are information only, and we do not guarantee our support on their operation and contents.

Operation of sample programs listed here are verified with our personal computers, however, we do not guarantee operations for any environment.

(1) Sample 1 - To access the task port (server port) of Web Controller

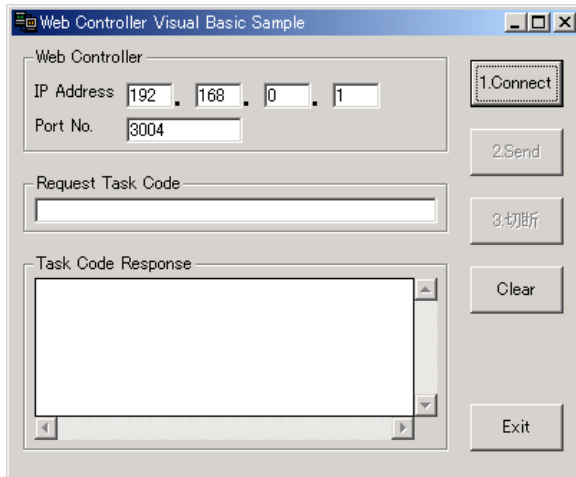

1. Click the [Connect] button to open connection to the IP address/Port No. specified in [Web Controller to be connected]
2. Click the [Send] button to send the task code specified in [Request task code].
3. The response to the request task code is displayed in [Response task code].
4. Click the [Clear] button to clear the contents in the [Request task code] column.
5. Click the [Exit] button to end the software.

Source code sample using Visual

```
Option Explicit                                'Forced variable declaration
Option Compare Text                          'Not case sensitive
Private Const HEADER = "0000FFFF0000"      'Request task code(H00)+Serial
Number(H00)+LUMP address(FFFF0000)

'Form load
Private Sub Form_Load()
    'Set the initial IP address
    IPText(0).Text = "192"
    IPText(1).Text = "168"
    IPText(2).Text = "0"
    IPText(3).Text = "1"
    PortText.Text = "3004"                    'Set the initial Port No.
    SendText.Text = ""                       'Initialization of Transmission task code
    ReceiveText.Text = ""                   'Initialization of monitor
    Call Command_Enabled_Sub(0) 'Enabled the Send, Receive, Disconnect buttons.
End Sub
'Connect
Private Sub ConnectCommand_Click()

    'Specify the IP address to be connected
    Winsock1.RemoteHost = IPText(0).Text & "." & IPText(1).Text & "." & _
        IPText(2).Text & "." & IPText(3).Text
    Winsock1.RemotePort = PortText.Text      'Specify the Port No. to be connected
    Winsock1.Connect                        'Open TCP/IP connection
    Call Command_Enabled_Sub(1) 'Enabled the Send, Receive, Disconnect buttons (返るまで)

End Sub
'Send
Private Sub SendCommand_Click()
    Dim Bin() As Byte

    Call AscToBin(HEADER & SendText.Text, Bin) 'Binary conversion of sending data
    Winsock1.SendData Bin                      'Send data

End Sub
```

(Continues to the next page)

(Continued from the previous page)

```

'Binary conversion
Private Sub AscToBin(ByVal Data As String, ByRef Bin() As Byte)

    Dim i&
    If Len(Data) Mod 2 Then      'When the length of character strings is an odd number, add
'0" at the end
        Data = Data & "0"
    End If
    ReDim Bin(0 To Len(Data) / 2 - 1)
    For i = 0 To Len(Data) / 2 - 1
        Bin(i) = "&h" & Mid(Data, i * 2 + 1, 2)    'Stores in buffer after binary conversion
    Next
End Sub
'Disconnect
Private Sub StopCommand_Click()

    Winsock1.Close          'Set connection close
    Call Command_Enabled_Sub(0) 'Enabled the Send, Receive, Disconnect buttons.
End Sub
'Monitor clear
Private Sub ClearCommand_Click()

    ReceiveText.Text = ""    'Initialization of monitor
End Sub
'Completion
Private Sub EndCommand_Click()

    Winsock1.Close          'Set connection close
    End                    'End

End Sub
'Generated when new data is transferred.
Private Sub Winsock1_DataArrival(ByVal bytesTotal As Long)
    Dim Bin() As Byte
    Dim HData As String
    Dim RData As String
    Dim i As Long

    Winsock1.GetData Bin
    If bytesTotal >= 2 Then
        RData = ""
        For i = 6 To bytesTotal - 1    '6 : Take data from response task code
            HData = Hex(Bin(i))
            If Len(HData) = 1 Then
'After converted to a hexadecimal number, put "0" at the end for one digit number.
                RData = RData & "0" & HData
            Else
                RData = RData & HData
            End If
        Next i
    End If

    'Display Receiving Data
    If ReceiveText.Text = "" Then
        ReceiveText.Text = RData
    Else
        'Put a line break
        ReceiveText.Text = ReceiveText.Text + Chr(13) + Chr(10) + RData
    End If

End Sub
'Set the button enabled when executing Send
Private Sub Command_Enabled_Sub(ByVal En_F As Byte)

    If En_F = 0 Then
        'Waiting for the connection open
        ConnectCommand.Enabled = True    'Connect
        SendCommand.Enabled = False      'Send
        StopCommand.Enabled = False      'Disconnect
    Else
        'Connecting
        ConnectCommand.Enabled = False    'Connect
        SendCommand.Enabled = True        'Send
        StopCommand.Enabled = True        'Disconnect
    End If

End Sub

```

## (2) Sample 2 - To receive data from Web Controller (TCP/IP server)

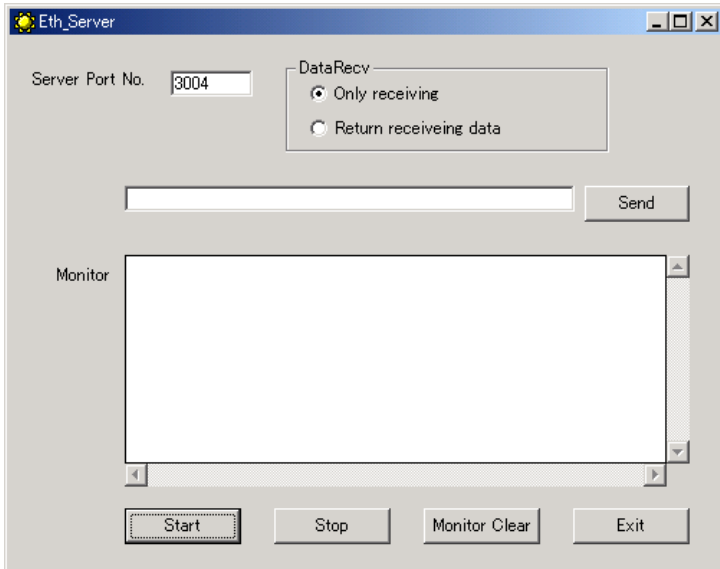

1. Click the [Start] button to wait for the connection request at the port number specified in "Server Port No."
2. Click the [Send] button to send the Send Column data to the active port.
3. Click the [Cancel] button to disconnect.
4. Click the [Monitor Clear] button to clear the display of the [Monitor] column.
5. Click the [Exit] button to end the software.

```

Option Explicit                                'Forced variable declaration
Option Compare Text                            'Not case sensitive
Public JBUF As String
Public Port_No As String
Public Time_cnt As Integer
Public ReEnd_flg As Integer
'Form Load
Private Sub Form_Load()
    Monitor_Text.Text = "" 'Initialization of monitor
End Sub
'Monitor clear
Private Sub ClearCommand_Click()
    Monitor_Text.Text = "" 'Initialization of monitor
End Sub
'End
Private Sub EndCommand_Click()
    tcpServer.Close
End Sub
End Sub

Source code sample using Visual Basic

    tcpServer.SendData SText.Text

End Sub
'Cancel
Private Sub StopCommand_Click()
    tcpServer.Close 'Set connection close
    ReEnd_flg = 2
    Monitor_Text.Text = Monitor_Text.Text + "Cancelled + Chr(13) + Chr(10)
End Sub
'Waiting for the connection request
Function tcpConnect()
    "Set whole number to LocalPort property
    tcpServer.LocalPort = Port_No
    'Call out listen method
    tcpServer.Listen
    Monitor_Text.Text = Monitor_Text.Text + "Waiting for connection open" + Chr(13) + Chr(10)
End Function

```

(Continues to the next page)



(Continued from the previous page)

```

'Generated when remote machine requests connection
Private Sub tcpServer_ConnectionRequest(ByVal requestID As Long)
Dim IP_Ad As String
Dim Po_No As String
    'Confirms if the control status is closed. If not,
    'accept new connection after closing current connection.
    If tcpServer.State <> sckClosed Then tcpServer.Close
    'Accepts request with the requestID parameter
    tcpServer.Accept requestID
    IP_Ad = tcpServer.RemoteHostIP
    Po_No = tcpServer.RemotePort
    Monitor_Text.Text = Monitor_Text.Text + "Connection established   IP_Addr: " + IP_Ad + "
Port_No: " + Po_No + Chr(13) + Chr(10)
End Sub
'Starts test
Private Sub testCommand_Click()
Dim i As Integer
    While True 'Endless loop
        Port_No = LoPortText1.Text
        Call tcpConnect 'TCP server processing
        ReEnd_flg = 0 'Reception end flag clear
        Do
            DoEvents 'Wait for the END of TCP server reception
        Loop Until ReEnd_flg >= 1
        If ReEnd_flg = 2 Then 'Cancelled
            Exit Sub
        End If
    Wend
End Sub
'Generated when new data is sent
Private Sub tcpServer_DataArrival(ByVal bytesTotal As Long)
    'Declares variable for receiving data. Call out GetData method, and set the data to the Text property of
the txtOutput textbox.
Dim strData() As Byte
Dim HEX_DAT As Variant
Dim i As Long
ReDim bSendData(256) As Byte 'Sending data (in bytes)
    'Receiving message
    tcpServer.GetData strData
    'Data conversion
    JBUF = ""
    For i = 0 To bytesTotal - 1 'Takes out from serial number
        HEX_DAT = Hex(strData(i))
        If Len(HEX_DAT) = 1 Then
            'After converted to a hexadecimal number, put "0" at the end for one digit number.
            JBUF = JBUF & "0" & HEX_DAT
        Else
            JBUF = JBUF & HEX_DAT
        End If
    Next i
    Monitor_Text.Text = Monitor_Text.Text + "Message received: " + JBUF + Chr(13) + Chr(10)
    'Determined if response is received
    If LANOption(1).Value = True Then
        'Response received
        For i = 1 To Len(JBUF)
            'Converts sending data
            bSendData(i - 1) = Asc(Mid(JBUF, i, 1))
        Next i
        'Set it the same as the data length
        ReDim Preserve bSendData(Len(JBUF) - 1)
        tcpServer.SendData bSendData
        Monitor_Text.Text = Monitor_Text.Text + "Message sent: " + JBUF + Chr(13) + Chr(10)
    End If
End Sub

```

(Continues to the next page)

(Continued from the previous page)

```
Private Sub tcpServer_close()  
    tcpServer.Close 'Set connection close  
    Do  
        DoEvents 'Wait for the normal end  
    Loop Until tcpServer.State = sckClosed  
    Monitor_Text.Text = Monitor_Text.Text + "Closed from client" + Chr(13) + Chr(10)  
    ReEnd_flg = 1 'End flag ON  
End Sub
```

***MEMO***